

Preisliste Deutschland – LED-Leuchten
Price List Germany – LED Luminaires

07/2022

nimbus^x + L●X5



Gültig ab 01. Juli 2022 / Valid from 1st of July 2022



Umsetzung der Ökodesign-Verordnung 2019/2020 und Energie-Label-Verordnung 2019/2015 der EU

Die EU-Verordnungen 2019/2020 und 2019/2015 treten ab dem 01.09.2021 für Lampen und Leuchten in Kraft.

Dank unserer nachhaltigen Konstruktionskonzepte sind wir in der Lage, im Falle eines Defektes, die Lichtquelle (LED-Modul) zerstörungsfrei aus den Leuchten zu entnehmen und zu ersetzen. Daher gelten diese Leuchten als „umgebendes Produkt“ und müssen künftig kein Energie-Label mehr tragen. Ausnahmen im Portfolio: Die Loox-Produkte und die Roxxane Fly CL. Diese sind als „Lichtquelle“ definiert und fallen unter die Energie-Label-Pflicht.

Die Energieeffizienzklassen aller Lichtquellen finden Sie in den jeweiligen Datenblättern auf unserer Website. Die Registrierung in der EPREL Datenbank ist erfolgt.

Mit dem Erscheinen dieser Preisliste verlieren alle vorausgegangenen Preisangaben ihre Gültigkeit. Trafos (Konverter) sind im Lieferumfang nicht enthalten, falls nicht anders angegeben. Gestalterische und technische Änderungen sowie Preisänderungen behalten wir uns vor. Alle technischen Angaben unterliegen bauteil- und/oder bauartbedingt einer Toleranz von 10 %.

Für Druckfehler in der Preisliste übernehmen wir keine Haftung. Dateien zur Lichtberechnung sowie bebilderte Montageanleitungen finden Sie auf unserer Webseite im Downloadbereich unter www.nimbus-lighting.com.

Es gelten ausschließlich die allgemeinen Geschäftsbedingungen der Nimbus Group, einzusehen unter www.nimbus-group.com. Unsere Produkte entsprechen europäischen technischen Standards und sind CE-zertifiziert.

Alle technischen Angaben beziehen sich auf die Leuchtenausführungen in 2700 K, 3000 K, 4000 K und 5000 K.

Die in der Preisliste ausgewiesenen Nettopreise verstehen sich zzgl. der gesetzlichen Mehrwertsteuer von 19 %.

Die in der Preisliste ausgewiesenen Bruttopreise verstehen sich inkl. der gesetzlichen Mehrwertsteuer von 19 %.



DESIGN PLUS

Implementation of EU Regulations on Ecodesign 2019/2020 and Energy Labelling 2019/2015

EU Regulations 2019/2020 and 2019/2015 enter into force for lamps and luminaires on 1 September 2021.

Thanks to our sustainable design concepts, in the event of a defect we are able to remove the light source (LED module) from the luminaires without having to destroy the product. The light source can then be replaced. The luminaires are therefore considered „containing products“ and no longer need to bear an energy label. Exceptions in our portfolio: Loox products and the Roxxane Fly CL. These are defined as a „light source“ and are therefore subject to mandatory energy labelling.

You will find the energy efficiency class of all our light sources on the datasheets on our website. Registration in the EPREL database has been completed.

Upon publication of this price list all our previous price information loses its validity. Converters are not included, if not mentioned otherwise. Subject to alterations in design, price and technical details. All technical details are subject to a tolerance of 10% due to differences in construction and/or the components used. We accept no liability for any printing errors on the price list. Data files for light calculation as well as mounting instructions with pictures can be found in the download area of our website at www.nimbus-lighting.com.

The General Terms of Business of the Nimbus Group are applicable and can be viewed at www.nimbus-group.com.

Please note that our products correspond to European technical standards and CE certification.

All technical details are based on the 2700 K, 3000 K, 4000 K, and 5000 K versions of our luminaires.

The net prices shown in the price list are without statutory value-added tax of 19 %.

The gross prices shown in the price list are with statutory value-added tax of 19 %.

Nimbus Group GmbH, Stuttgart, www.nimbus-group.com



 Nicht enthaltene Zubehör ist farbig gekennzeichnet.
Accessories not included in delivery are marked in colour.

member of  **Rat für Formgebung**
German Design Council



Die Nimbus Group ist Gründungsmitglied der DGNB
(Deutsche Gesellschaft für Nachhaltiges Bauen)
The Nimbus Group is a founding member of the DGNB
(German Sustainable Building Council)

INHALT / CONTENTS

- 2 DESIGN, INNOVATIONSKRAFT UND VISIONEN /
DESIGN, INNOVATIVE ABILITY AND VISIONS
- 4 NIMBUS UND LOOX5 NEUHEITEN /
NEW PRODUCTS FROM NIMBUS AND LOOX5
- 8 Q FOUR/Q ONE FAMILIE /
Q FOUR/Q ONE FAMILY
- 10 PROJEKTBEISPIELE /
PROJECT SAMPLES
- 20 DIE NIMBUS LICHTSTEUERUNGSLÖSUNGEN /
THE NIMBUS LIGHT MANAGEMENT SOLUTIONS
- 22 ANWENDUNGSGEBIETE DER NIMBUS LICHTSTEUERUNGSLÖSUNGEN /
APPLICATION AREAS OF THE NIMBUS LIGHT MANAGEMENT SOLUTIONS
- 24 LEUCHTENFAMILIEN ALPHABETISCH /
LUMINAIRE FAMILIES IN ALPHABETICAL ORDER
- 25 LEUCHTENFAMILIEN NUMERISCH /
LUMINAIRE FAMILIES IN NUMERICAL ORDER
- 26 LEUCHTEN NACH FAMILIEN /
LUMINAIRES ARRANGED BY FAMILY
- 104 STEUEREINHEITEN CASAMBI /
CONTROL UNITS CASAMBI
- 105 INFORMATIONEN ZU KONVERTERN UND DIMMERN /
INFORMATION ON CONVERTERS AND DIMMERS
- 108 PLANUNGSHINWEISE /
PLANNING INFORMATION

DESIGN, INNOVATIONSKRAFT UND VISIONEN

Eine Architekturmarke, richtungsweisende einzigartige Produkte, die das Leben und Arbeiten verbessern, gestalterische Lösungen auf höchstem ästhetischen Niveau, charakteristische Designsprache, Innovation und Visionen – für all das steht Nimbus.

Seit Februar 2019 gehört Nimbus zur Häfele Unternehmensgruppe und erweitert deren Portfolio im Bereich Licht und Akustik mit dem Ziel, die Kompetenzen beider Unternehmen – Innovationsgeist, hohe unternehmerische Dynamik, Qualität und Service nach deutschem Maßstab – zu bündeln und ganzheitliche und vernetzte Raumkonzepte mit Licht und Akustik zu entwickeln.

Nimbus, im Jahr 1988 vom Architekten Dietrich F. Brennenstuhl gegründet, avancierte 2006 mit der radikalen Umstellung auf die LED-Technologie zum LED-Pionier der Lichtbranche, realisierte seitdem über 20.000 LED-Projekte und wartet regelmäßig mit bahnbrechenden Innovationen auf: zum Beispiel im Jahr 2016 mit der Cableless-Leuchterserie, die zum ersten Mal ausgereifte, kabellose Leuchten mit hohem Designanspruch auf den Markt brachte, oder 2018 mit dem Lighting Pad, der Verbindung von Licht und Akustik zu einem einzigartigen Produkt.

Das Angebot der Nimbus-Leuchten, ausgezeichnet mit bedeutenden internationalen Designpreisen, energieeffizient, langlebig und nachhaltig, wird in dieser Preisliste erweitert um einen Auszug aus dem Loox-Programm von Häfele. Loox5-Lichtbänder bestechen durch ihre Flexibilität in der Anwendung, durch die Einfachheit in der Montage – sie sind ohne Elektrofachkenntnisse installierbar und einfach steck- und kombinierbar – durch ihre hohe, dauerhafte Qualität, ihre Langlebigkeit und durch ihre weltweite Kompatibilität dank des einzigartigen Loox5-Netzteils. Beide Produktwelten verschmelzen zunehmend am Standort Stuttgart miteinander, wo das neue Kompetenzzentrum für Licht und Akustik stetig ausgebaut wird.



Geschäftsleitung von Nimbus: Dietrich Brennenstuhl (l), Jörg Schmid (r)
Management of Nimbus: Dietrich Brennenstuhl (l), Jörg Schmid (r)



Produktion von Nimbus in Stuttgart
Production of Nimbus in Stuttgart



Firmensitz von Nimbus in Stuttgart
Nimbus Headquarter in Stuttgart

DESIGN, INNOVATIVE ABILITY AND VISIONS

An architecture brand; trendsetting, unique products that enhance our life and work; design solutions at the highest aesthetic level; characteristic design idiom, innovation and visions – that is what Nimbus is all about.

Since February 2019, Nimbus has belonged to the Häfele Group, where it has expanded the company's portfolio in the fields of lighting and acoustics. The goal is to pool the two companies' strengths – spirit of innovation, high level of entrepreneurial dynamism, quality and service in line with German standards – and develop holistic and connected room concepts with light and acoustics.

Founded by the architect Dietrich F. Brennenstuhl in 1988, Nimbus became the LED pioneer of the lighting sector in 2006 with its radical switch to LED technology. Since that time, it has realised over 20,000 LED projects and regularly turns out trailblazing innovations. In 2016, for example, it launched its range of cableless luminaires: the first perfected, cableless luminaires with high design standards ever seen on the market. 2018 saw the introduction of the Lighting Pad, which combines light and acoustics in one unique product.

Nimbus luminaires have won major international design prizes; they are energy-efficient, durable and sustainable, and in this pricelist they are joined by products from Häfele's Loox range. Loox5 strip lights stand out thanks to their versatility and ease of installation: you don't have to be a qualified electrician and can simply plug them in and combine them as you wish. Other great features include lasting quality, durability and global compatibility thanks to the unique Loox5 power supply unit. The two product worlds are increasingly merging into one at the location in Stuttgart, where the new Centre of Competence for Light and Acoustics is being constantly expanded.



NEW COLOURS

ROXXANE HOME 83

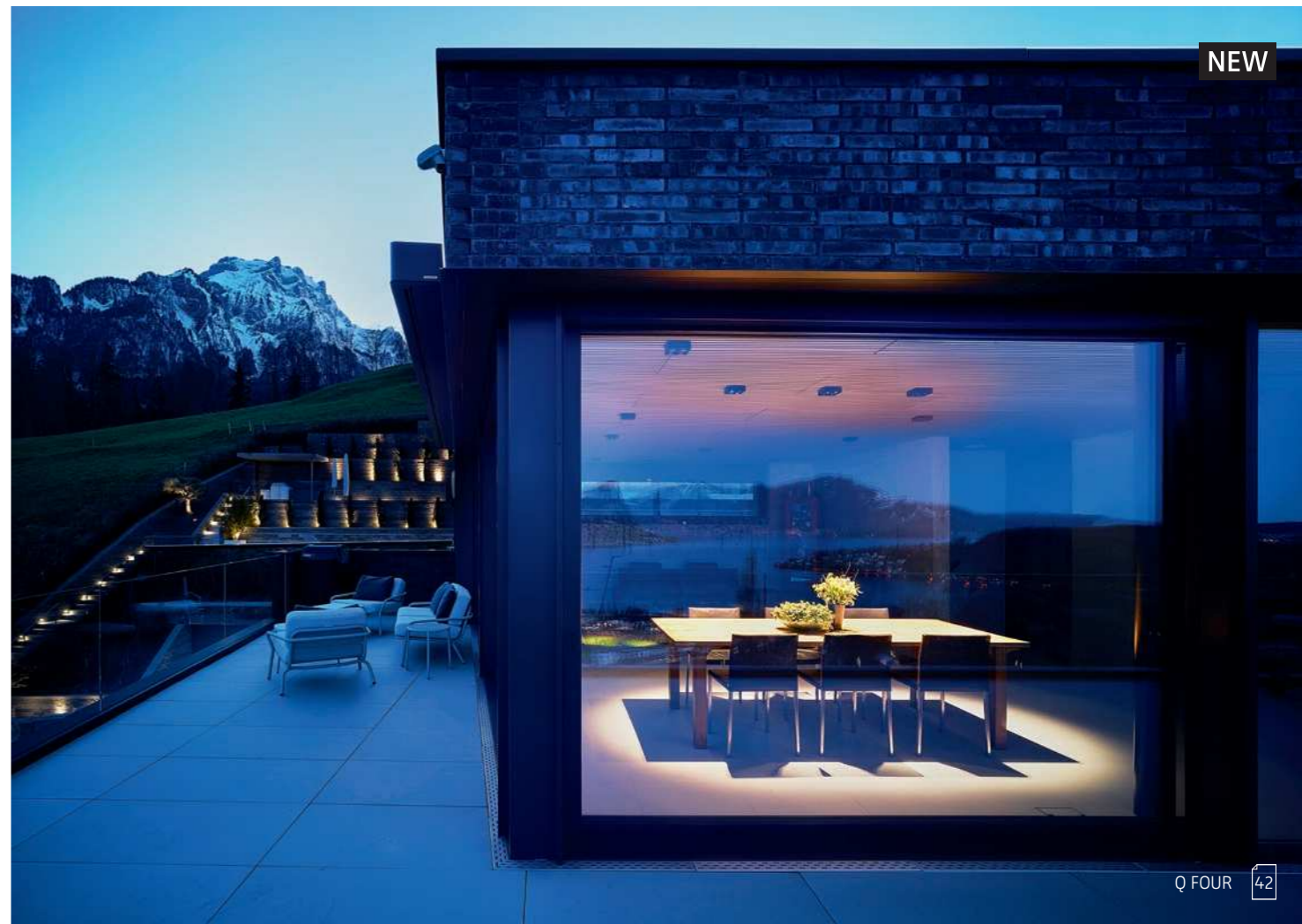

NEW

Q FOUR 42



NEW

LIGHTING PAD LOUNGE 38

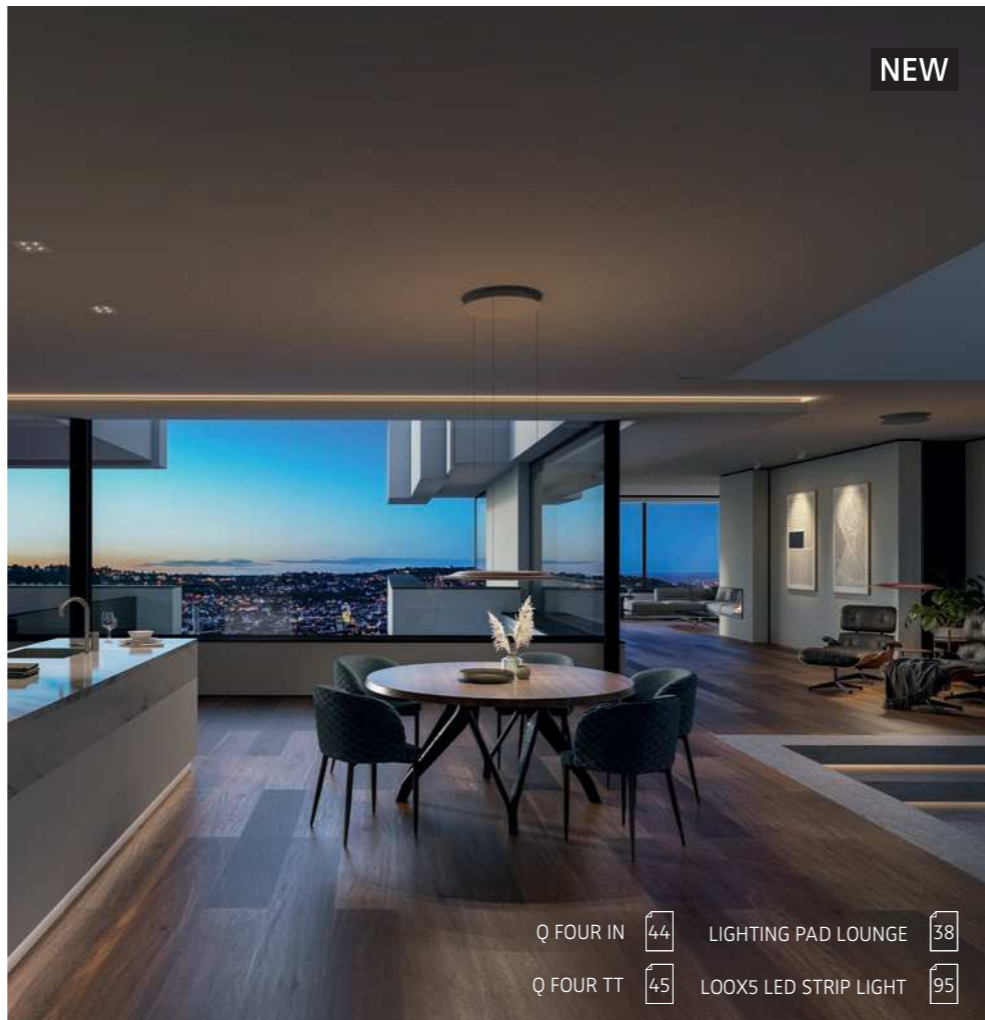

NEW

Q FOUR IN 44 LIGHTING PAD LOUNGE 38
 Q FOUR TT 45 LOOX5 LED STRIP LIGHT 95



NEW COLOURS

ROXXANE LEGGERA 101 CL 86

NEW



LOOX5 LED STRIP LIGHT 95 Q FOUR 42

Q FOUR/Q ONE FAMILIE /
Q FOUR/Q ONE FAMILY

NEW



Q FOUR TT 45

NEW



Q FOUR TT AUFBAU 46

NEW



Q ONE IN 41



Q ONE 40

NEW



Q FOUR IN 44

NEW



Q FOUR TT TRACK 47



Q FOUR 42

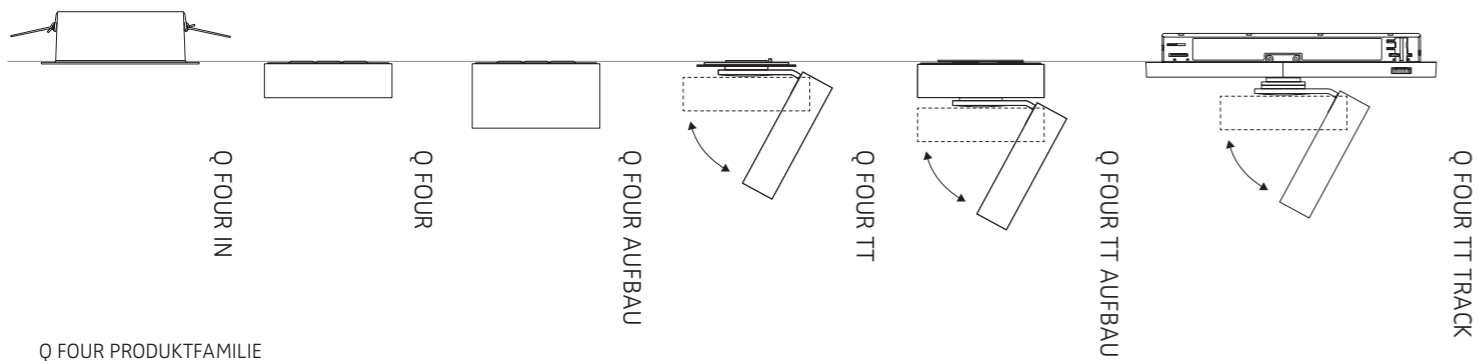

Q FOUR PRODUKTFAMILIE
Q FOUR PRODUCT FAMILY



Wohnhaus „Haus am Eichenberg“ (AT)
Residence „Haus am Eichenberg“ (AT)
Modul R 36, Modul R 36 TT, Modul R 36 Aqua

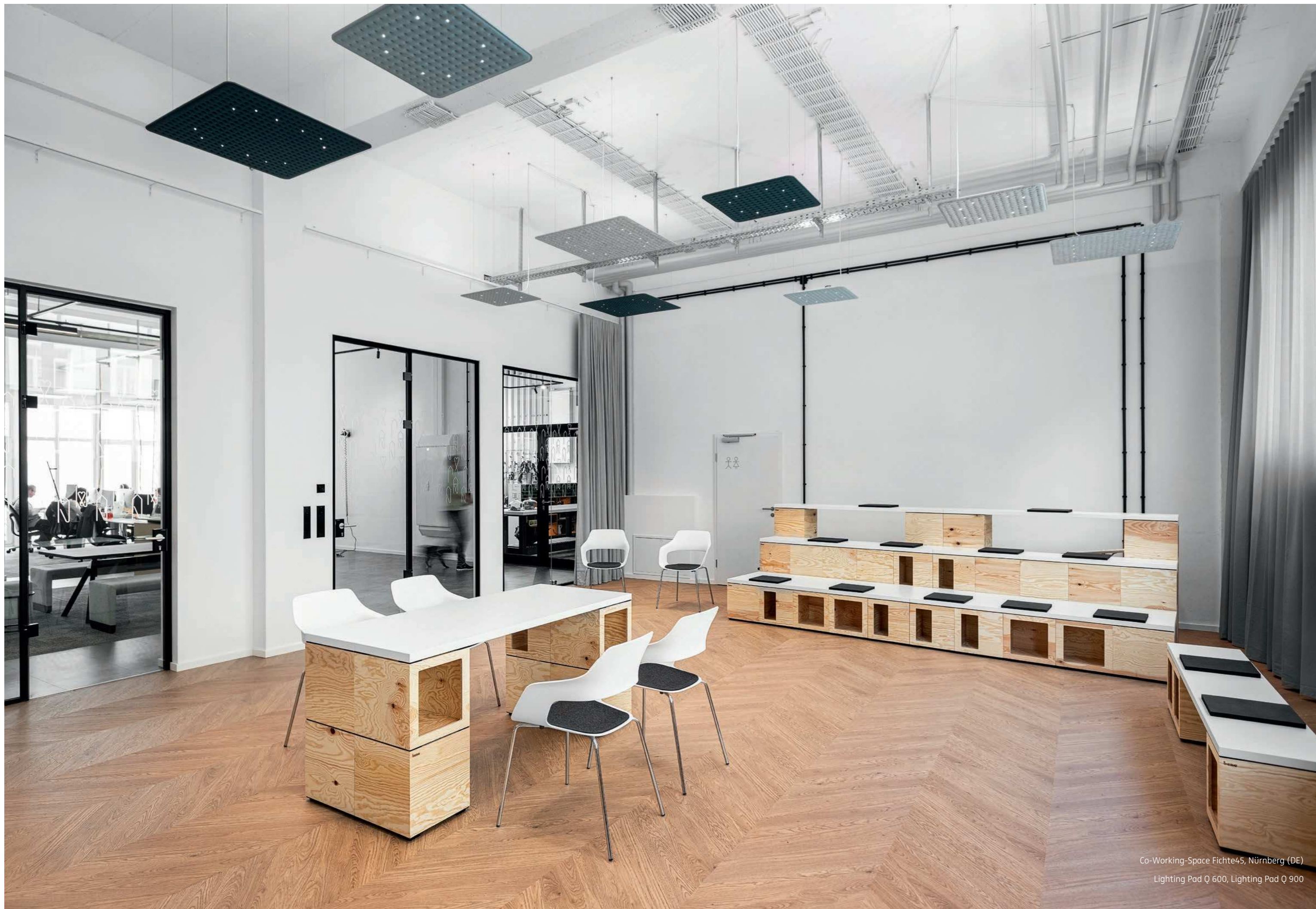

Co-Working-Space Fichte45, Nürnberg (DE)
Lighting Pad Q 600, Lighting Pad Q 900

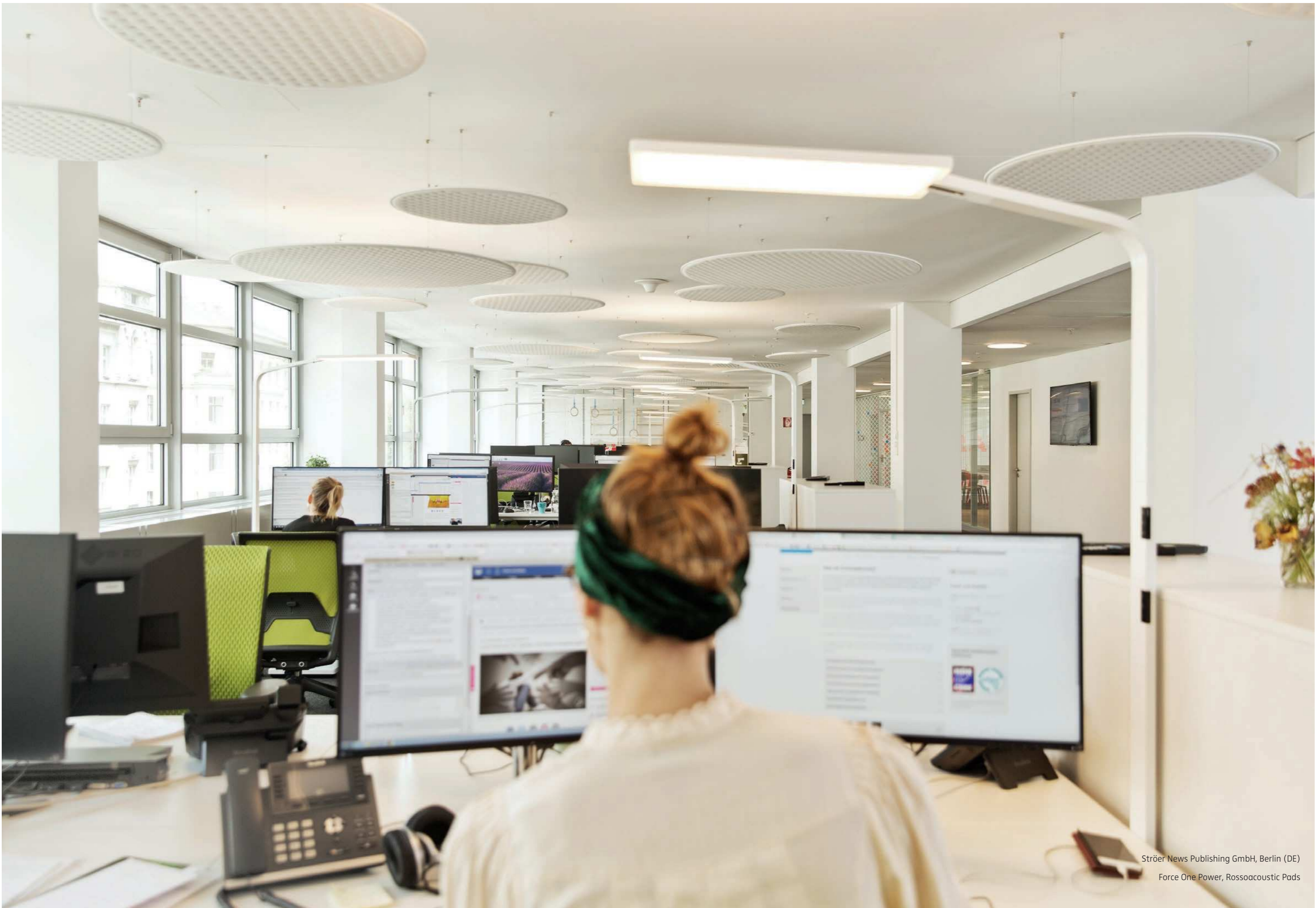

Ströer News Publishing GmbH, Berlin (DE)
Force One Power, Rossoacoustic Pads



Büro Andy Wolf Fashion, Hartberg (AT)
Andy Wolf Headquarter, Hartberg (AT)
Modul L 196, Modul Q 36 TT, Modul Q 36,
Modul Q 600 Project, Modul Q 900 Project



Wohnhaus Vierwaldstättersee (CH)
Residence Lake Lucerne (CH)

Q FOUR, CUBIC

DIE NIMBUS LICHTSTEUERUNGSLÖSUNGEN / THE NIMBUS LIGHT MANAGEMENT SOLUTIONS

Nimbus Leuchten lassen sich über verschiedenste Technologien ansteuern, dimmen und zu Lichtnetzwerken ausbauen.

Bis auf die neuen Leuchtenfamilien Q FOUR und Q ONE sind Deckenleuchten von Nimbus Konstantspannungsleuchten (24 V DC) und werden über Pulsweitenmodulation (PWM) gedimmt. Konstantspannungsleuchten können parallel auf einen entsprechenden Konverter/Dimmer aufgeschaltet werden (siehe S. 108 Planungshinweise). Bezüglich der Dimmbarkeit der Leuchten beachten Sie deshalb bitte, dass aus EMV-Gründen der PWM-Dimmer – unabhängig von dem Leitungsquerschnitt – sich nicht weiter als 10 m von einer Leuchte entfernt befinden sollte.

Je nach Anwendungsbereich kann aus sieben Lichtsteuerungslösungen gewählt werden:

Nimbus luminaires can be activated, dimmed and grouped in lighting networks using a variety of technologies.

Except for the new Q FOUR and Q ONE families of luminaires, Nimbus ceiling luminaires are constant voltage luminaires (24 V DC) and are dimmed using pulse width modulation (PWM). Constant voltage luminaires can be connected in parallel to an appropriate converter/dimmer (see p. 108 Planning Information). For this reason, with respect to the dimming capability of the luminaire, please note that, for EMC reasons, the PWM dimmer should be no further than 10 m away from a luminaire, regardless of the size of the cable cross-section.

There is a choice of seven light control solutions for various types of use.

PHASENAN-/ABSCHNITTSDIMMUNG / TRAILING / LEADING EDGE DIMMER



Nahezu alle Nimbus Leuchten sind über die bestehende Hausinstallation mit 3-adriger Leitung dimmbar! Sie benötigen dazu lediglich einen klassischen Wanddimmer (Phasendimmer, als Tast- oder Drehdimmer-Variante) und einen 75-W-Sammelkonverter (555-916). Bitte beachten: Es muss eine Mindestlast von 12 W angelegt werden. Je höher die Gesamtanschlussleistung, desto weiter können die Leuchten im unteren Bereich gedimmt werden. Die Aufbauleuchten Modul Q 36 FRAME und CUBIC 36 FRAME haben diese Technologie bereits integriert!

Almost all Nimbus luminaires can be dimmed via existing building installations with a 3-core cable! All you need is a regular wall dimmer (phase dimmer realised as either a push button or rotary switch) and a 75 W central converter (555-916). Please note: a minimum load of 12 W must be applied. The higher the total wattage, the further the luminaires can be dimmed down. This new technology is already integrated in the Modul Q 36 FRAME and CUBIC 36 FRAME surface-mounted luminaires!

SWITCHDIM

Eine einfache und kostengünstige Möglichkeit der Dimmung, bei der lediglich ein Netzspannungstaster zur Lichtsteuerung benötigt wird. Damit wird jede Leuchte durch Betätigung des Tasters dimmbar. Bis zu vier elektronische Vorschaltgeräte (EVG) können durch Tastenbedienung gesteuert werden. Die unterschiedlichen Schalt- und Dimmfunktionen werden aus dem momentanen Betriebszustand und der Dauer des Tastendruckes abgeleitet. Bei Ansteuerung von mehreren Dimmern über einen Taster müssen diese unter Umständen synchronisiert werden. Dies kann geräteabhängig per Taster oder über einen bauseitigen DALI-Controller erfolgen.

With this technology, the lighting is controlled by a line-voltage switch. Any luminaire can be dimmed by pushing the switch. Up to four electronic ballasts can be controlled by means of the switch. The various switching and dimming functions are based on the current mode and the length of time the switch is pressed. If multiple dimmers are activated via one push button, they may need to be synchronised. Depending on the device in question, this can be done using a push button or DALI controller already installed in the building.

CASAMBI

Nahezu alle Nimbus LED-Leuchten lassen sich mit Casambi einfach und flexibel via Smartphone oder Tablet steuern und dimmen. Um die Funktechnologie über Bluetooth nutzen zu können, benötigen Sie die kostenfreie Casambi-App und Nimbus Leuchten mit Casambi-Steuereinheit. Auch bereits vorhandene LED-Leuchten lassen sich mit dieser Lösung zum Großteil nachrüsten. Außergewöhnlich dabei: Leuchten, die mit 3-adriger Verkabelung angeschlossen sind, können damit gedimmt werden – über Smartphone oder Wandschalter.

Almost all Nimbus LED luminaires feature the option of simple and flexible control and dimming via smartphone or tablet using Casambi. If you wish to use this wireless Bluetooth technology, you will need the free Casambi app and Nimbus luminaires with a Casambi control unit. Most existing LED luminaires can also be retrofitted with this solution. What is so special about this solution is the fact that luminaires connected with 3-core cables can be dimmed – via smartphone or wall switch.

DALI

Um eine Lichtsteuerung über eine DALI-Steuereinheit (Digital Addressable Lighting Interface) zu realisieren, benötigt man eine 5-adrige Verkabelung oder neben der 230-V-Versorgung der Netzteile eine separate 2-adrige Steuerleitung zur Leuchte bzw. zu den entsprechenden Dimmeinheiten. Bis zu 63 elektronische Vorschaltgeräte (EVG) können über eine DALI-Steuereinheit gedimmt werden. Die maximale Leitungslänge beträgt bei Verwendung von 1,5 mm² Leitern eine Länge von 300 Metern.

To realise light control via a DALI (Digital Addressable Lighting Interface) control unit, you need a 5-core cable or a separate 2-core control cable to the luminaire or dimming units in addition to the 230 V supply of the power adapters. Up to 63 electronic ballasts can be dimmed via a DALI control unit. When using 1.5 mm² cables, 300 meters is the maximum cable length.

1–10 V

Die Dimmung über eine 1–10-V-Schnittstelle setzt eine VDE-konforme Verkabelung inkl. 2-adriger Steuerleitung von der Steuereinheit bis zur Leuchte bzw. den entsprechenden Dimmeinheiten voraus. Nimbus Leuchten, die eine solche Schnittstelle haben, können anschließend mit einem handelsüblichen 1–10-V-Dimmer oder über ein Gateway, zum Beispiel KNX, welches ein 1–10-V-Signal ausgibt, gedimmt werden.

Dimming via a 1–10 V interface requires a VDE-compliant 2-core control cable from the control unit to the luminaire or the corresponding dimming units. Nimbus luminaires with such an interface can then be dimmed using a normal 1–10 V dimmer or via a gateway such as KNX that emits a 1–10 V signal.



Mit ZigBee lassen sich unsere Nimbus LED-Leuchten ohne aufwändig zu installierendes Gebäudemanagementsystem zu richtigen Teamspielern aufrüsten. Egal ob Decken- oder Stehleuchte: Nahezu alle Nimbus Leuchten lassen sich in ein intelligentes Lichtnetz einbinden. Dank integrierter Funktechnologie und optionaler Sensorik kommunizieren unsere Leuchten kabellos mit anderen Leuchten im System. Über ein bedienfreundliches Interface erfolgt die Einrichtung des Leuchten-Netzwerks, in welchem die Leuchten beliebig zu Beleuchtungsgruppen und -szenarien konfiguriert werden können.

Für die Einrichtung und Steuerung der Lichtsteuerung ist ein ZigBee-basiertes Gateway erforderlich, das von externen Partnern beschafft, konfiguriert und in Betrieb genommen werden muss. Die Konfigurationsoptionen, Bedienoberflächen sowie die Einbindung von externer Sensorik oder Funktastern unterscheiden sich je nach Hersteller. In der Version ohne Sensorik sind Leuchten mit ZigBee-Funkmodul zum Beispiel über Philips Hue, Osram Lightify, Ubisys oder Dresden Elektronik steuerbar. Die Konfiguration von Nimbus ZigBee-Leuchten mit integrierter Sensorik (PDLs) ist ausschließlich über ein Gateway des Herstellers Dresden Elektronik möglich.

Our Nimbus LED luminaires can be upgraded to real team players by retrofitting them with ZigBee, thus doing away with the need for complex building management installations. Whether ceiling or floor-standing luminaires: almost all Nimbus luminaires can be integrated into an intelligent lighting network. Thanks to the integrated wireless technology and optional sensor system, our luminaires communicate wirelessly with other luminaires in the system. The lighting network is set up via a user-friendly interface allowing luminaires to be freely configured in lighting groups and scenarios.

A ZigBee-based gateway is necessary to set up and control the light control system. This gateway has to be procured, configured and put into operation by an external partner. The configuration options, user interface and integration of external sensors or wireless pushbuttons differ from manufacturer to manufacturer. In the version without sensors, luminaires with ZigBee wireless module can be controlled using Philips Hue, Osram Lightify, Ubisys or Dresden Elektronik, for example. The configuration of Nimbus ZigBee luminaires with integrated sensors (PDLs) is only possible via a gateway manufactured by Dresden Elektronik.

IQ SENSOR









Mit dieser Technologie bietet Nimbus Sensor-Deckenleuchten mit integrierter Präsenz- und Umgebungslichtsensorik an. Die Sensoren sind nahezu unsichtbar in den Leuchtenkopf integriert. Die IQ-Sensor-Leuchten reagieren auf Präsenz, Bewegung und vorhandenes Umgebungslicht. Je nach Beleuchtungsanforderung (des Nutzers) kann über drei integrierte Drehschalter die Nachleuchtdauer, die Aktivierung bzw. Deaktivierung der Leuchte bei einer wählbaren Umgebungshelligkeit sowie ein gedimmter Standby-Zustand gewählt werden.

With this technology, Nimbus is able to offer ceiling luminaires equipped with sensors for detecting presence and ambient light. The sensors have been integrated in the luminaire head so that they are practically invisible. The IQ sensor luminaires react to presence, movement and ambient light. The OFF delay, activation and deactivation of the luminaire at a selectable level of ambient brightness as well as a dimmed standby mode can all be selected by means of three integrated rotary switches to suit (the user's) lighting requirement.

Ausführliche Informationen zu den Nimbus Lichtsteuerungslösungen finden Sie unter nimbus-lighting.com/service/dimmung Planungshinweise finden Sie auf Seite 108.

You will find detailed information on Nimbus light control solutions at nimbus-lighting.com/en/service/dimmung You will find planning information on page 108.

ANWENDUNGSGEBIETE DER NIMBUS LICHTSTEUERUNGSLÖSUNGEN / APPLICATION AREAS OF THE NIMBUS LIGHT MANAGEMENT SOLUTIONS

Steuerungstechnologie Control technology	Anwendungsgebiet Application area	Technologiebasis Technology basis	in Gebäude- automation integrierbar Integration in building auto- mation possible	Nachrüsten im Bestand Retrofitting of existing installations	Funk Wire- less	dimmbar dimmable	Präsenz- und Umgebungslicht- sensorik (PDLS) Presence detection and ambient light sensor (PDLS)	Master-/ Slave- Schaltung Master / slave wiring	Virtuelle Gruppen und Szenen Virtual groups and scenarios	Steuerung Wandschalter Control via wall switch	Steuerung Smartphone / Tablet Control via smartphone / tablet
CASAMBI	 Homebereich Büroanwendung Home Office	Bluetooth / Casambi Bluetooth / Casambi		•	•	•			•	• ³ (AN/AUS/DIMMEN) (ON/OFF/DIM)	• ³
IQ Sensor	 Verkehrswege (Flur/WC) Commonly used areas (corridor/WC)	engineered by Nimbus engineered by Nimbus		•			•	•		• ³ (AN/AUS) (ON/OFF)	
 ZigBee Certified product	 Bürogebäude, öffentliche Gebäude Office building, public building	Zigbee-Standard Zigbee standard	•	•	•	•	• ²	•	•	• ³ (AN/AUS/DIMMEN) (ON/OFF/DIM)	• ³ (Schnittstellen- abhängig) (depends on interface)
Phasen-/ abschnitts- dimmung / Trailing / leading edge dimmer	 Homebereich Home	Elektroinstallation Electrical installation		•		•				• ³ (AN/AUS/DIMMEN) (ON/OFF/DIM)	
DALI	 Homebereich Büroanwendung Home Office	Elektroinstallation Electrical installation	•	• ¹		•			•	• ³ (AN/AUS/DIMMEN) (ON/OFF/DIM)	• ³
1-10 V	 Homebereich Büroanwendung Home Office	Elektroinstallation Electrical installation	•	• ¹		•				• ³ (AN/AUS/DIMMEN) (ON/OFF/DIM)	• ³
switchDim	 Homebereich Home	Elektroinstallation Electrical installation		• ¹		•				• ³ (AN/AUS/DIMMEN) (ON/OFF/DIM)	

¹ Steuerleitung wird benötigt.
¹ Control cable is needed.

² Optional.
² Optional.

³ Systemabhängig.
³ Depending on the
system.

Ausführliche Informationen zu den Nimbus Lichtsteuerungslösungen finden Sie unter nimbus-lighting.com/service/dimmung
You will find detailed information on Nimbus light control solutions at nimbus-lighting.com/en/service/dimmung

LEUCHTENFAMILIEN ALPHABETISCH / LUMINAIRE FAMILIES IN ALPHABETICAL ORDER

90	AIR MAXX SUPER POWER	89	RIM R
61	CUBIC	83	ROXXANE
81	FORCE ONE	85	ROXXANE FLY CL
34	LIGHTING PAD	86	ROXXANE LEGGERA CL
38	LIGHTING PAD LOUNGE	88	WINGLET CL
80	L 120	93	ZEN ON / ZEN IN
95	LOOX5		
91	MIKE INDIA		
76	MODUL L		
48	MODUL Q		
56	MODUL Q PROJECT		
64	MODUL R		
71	MODUL R PROJECT		
82	OFFICE AIR 2.0		
42	Q FOUR		
40	Q ONE		

LEUCHTENFAMILIEN NUMERISCH / LUMINAIRE FAMILIES IN NUMERICAL ORDER

34	LIGHTING PAD	88	WINGLET CL
38	LIGHTING PAD LOUNGE	89	RIM R
40	Q ONE	90	AIR MAXX SUPER POWER
42	Q FOUR	91	MIKE INDIA
48	MODUL Q	93	ZEN ON / ZEN IN
56	MODUL Q PROJECT	95	LOOX5
61	CUBIC		
64	MODUL R		
71	MODUL R PROJECT		
76	MODUL L		
80	L 120		
81	FORCE ONE		
82	OFFICE AIR 2.0		
83	ROXXANE		
85	ROXXANE FLY CL		
86	ROXXANE LEGGERA CL		

LEUCHTEN NACH FAMILIEN / LUMINAIRES BY FAMILIES

LIGHTING PAD

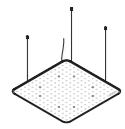

34 LIGHTING PAD Q 600

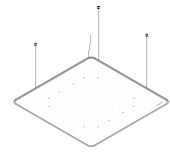

35 LIGHTING PAD Q 900

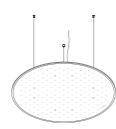

36 LIGHTING PAD R 600

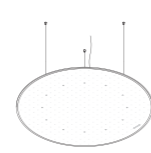

37 LIGHTING PAD R 900

LIGHTING PAD LOUNGE

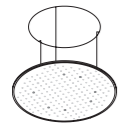

NEW

38 LIGHTING PAD LOUNGE R 600

Q ONE / Q FOUR

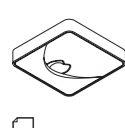

40 Q ONE

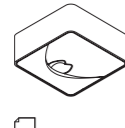

40 Q ONE AUFBAU

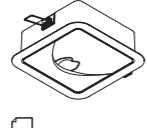

41 Q ONE IN

NEW

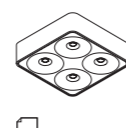

42 Q FOUR 40°

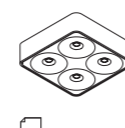

42 Q FOUR 80°

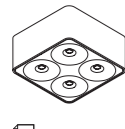

43 Q FOUR AUFBAU 40°

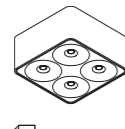

43 Q FOUR AUFBAU 80°

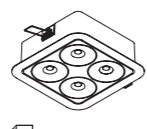

44 Q FOUR IN 40°

NEW

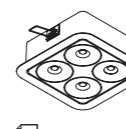

44 Q FOUR IN 80°

NEW

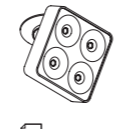

45 Q FOUR TT 40°

NEW

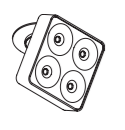

45 Q FOUR TT 80°

NEW

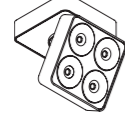

46 Q FOUR TT AUFBAU 40°

NEW

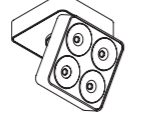

46 Q FOUR TT AUFBAU 80°

NEW

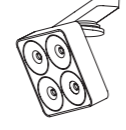

47 Q FOUR TT TRACK 40°

NEW

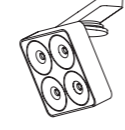

47 Q FOUR TT TRACK 80°

NEW

MODUL Q



48 MODUL Q 9



48 MODUL Q 9 AQUA

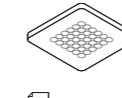

49 MODUL Q 36

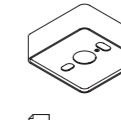

49 FRAME 36

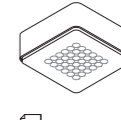

49 MODUL Q FRAME 36

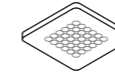

49 MODUL Q 36 AQUA

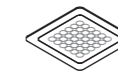

50 MODUL Q 36 IN

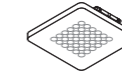

50 MODUL Q 36 TT

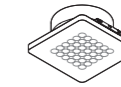

50 MODUL Q 36 TT

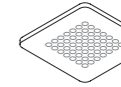

51 MODUL Q 49

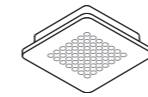

51 MODUL Q 49

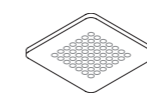

51 MODUL Q 49 AQUA

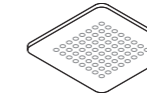

52 MODUL Q 64

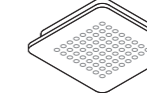

52 MODUL Q 64

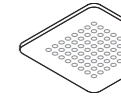

53 MODUL Q 64 AQUA

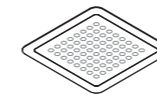

53 MODUL Q 64 IN

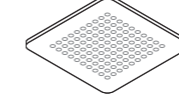

54 MODUL Q 100

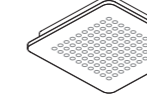

54 MODUL Q 100

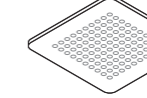

54 MODUL Q 100 AQUA

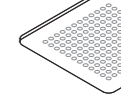

55 MODUL Q 144

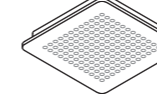

55 MODUL Q 144

MODUL Q PROJECT

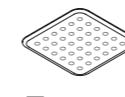

56 MODUL Q 220 PROJECT

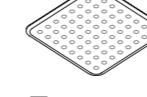

56 MODUL Q 280 PROJECT

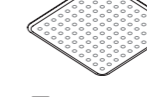

57 MODUL Q 340 PROJECT

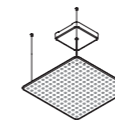

58 MODUL Q 600 PROJECT

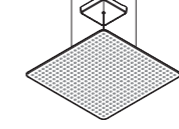

59 MODUL Q 900 PROJECT

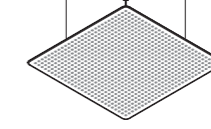

60 MODUL Q 1200 PROJECT

weiter auf der nächsten Seite
continue on next page

LEUCHTEN NACH FAMILIEN / LUMINAIRES BY FAMILIES

CUBIC

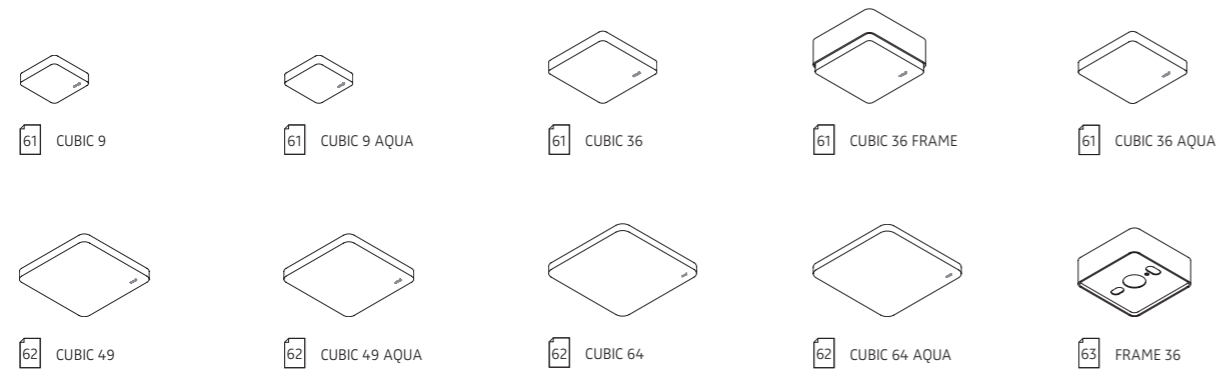

MODUL R

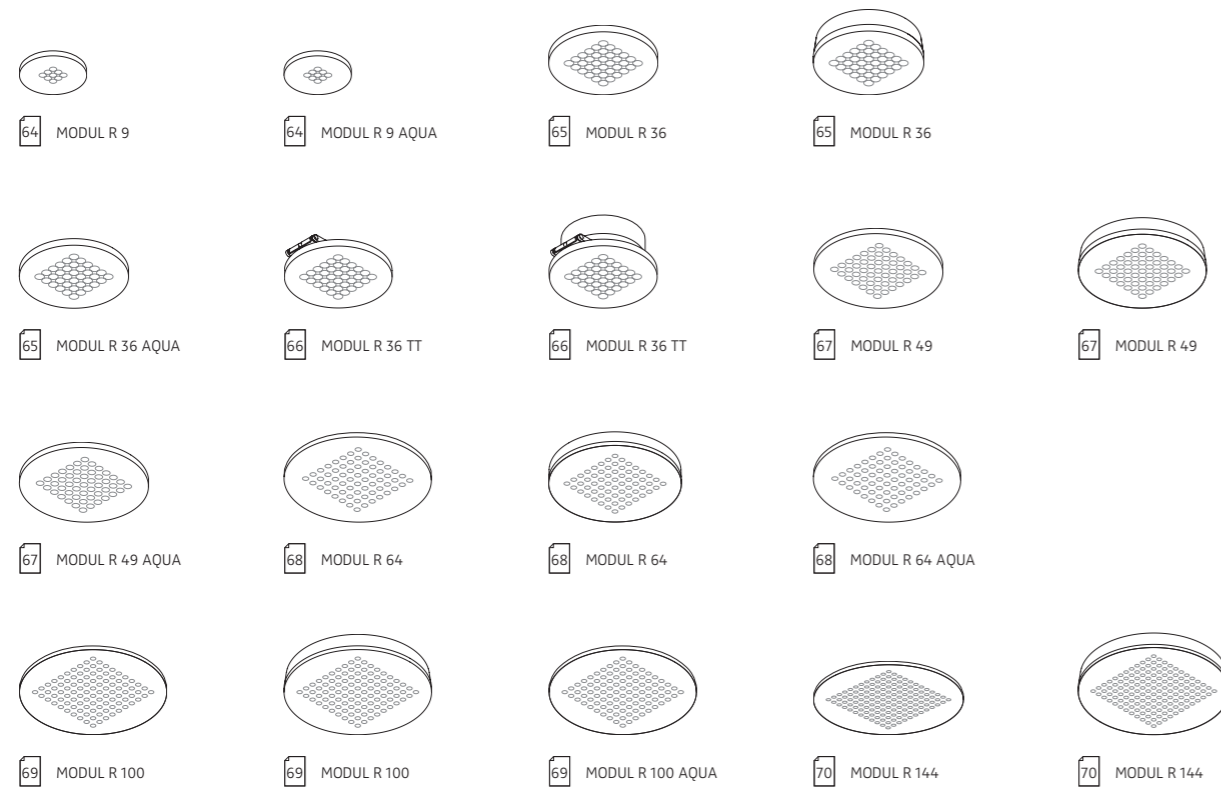

MODUL R PROJECT

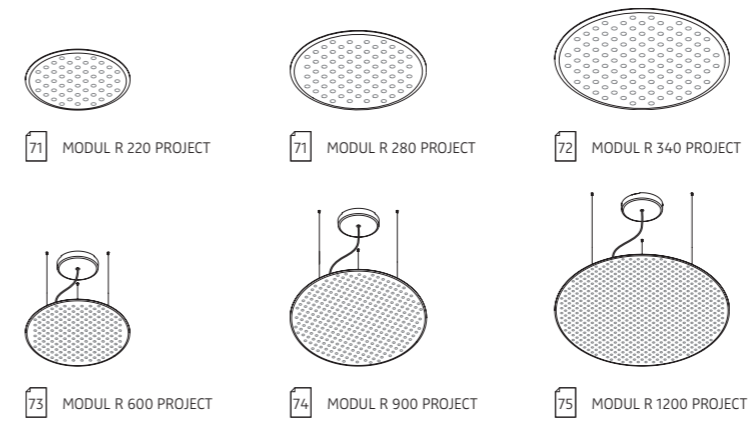

MODUL L

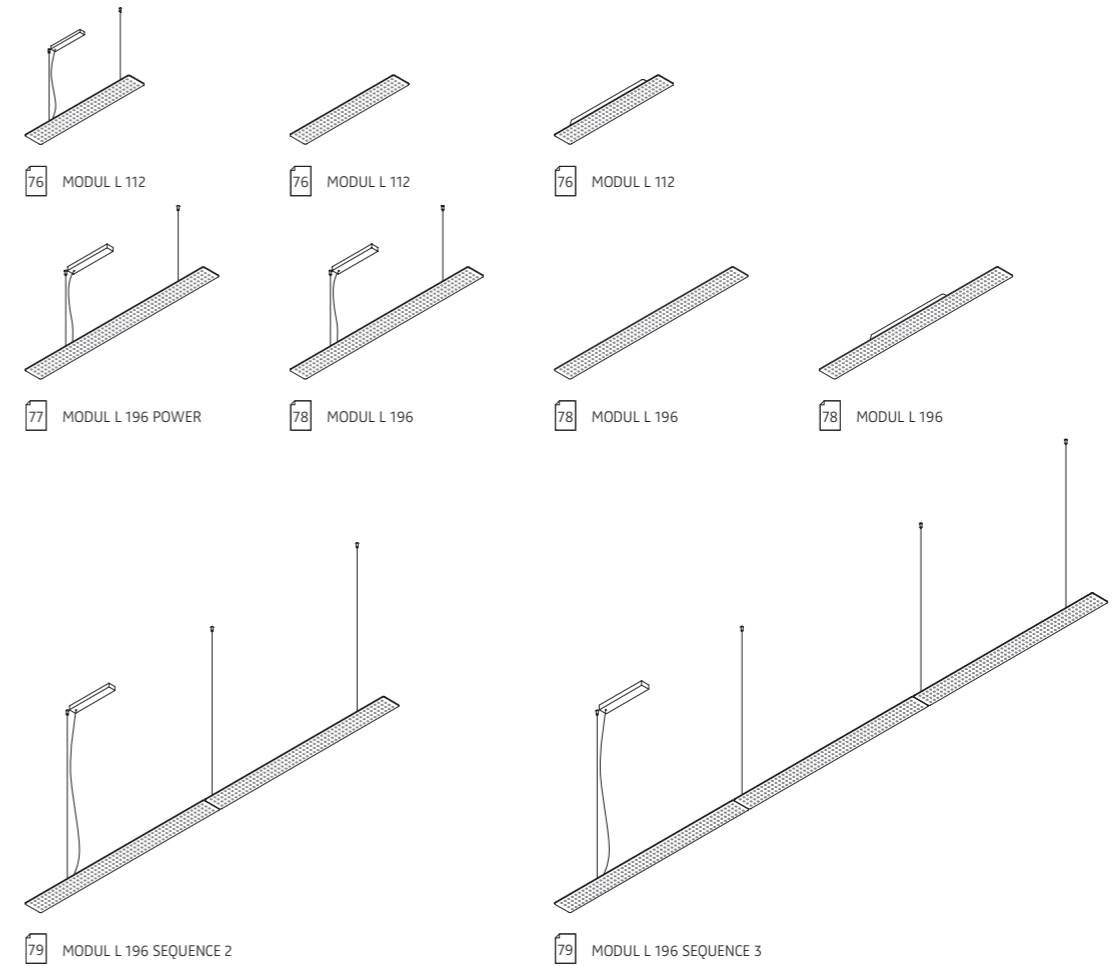

LEUCHTEN NACH FAMILIEN / LUMINAIRES BY FAMILIES

L 120

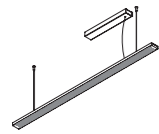

80 L 120

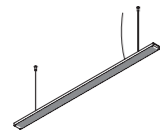

80 L 120

FORCE ONE



81 FORCE ONE



81 FORCE ONE POWER

OFFICE AIR 2.0



82 OFFICE AIR 2.0



82 OFFICE AIR 2.0 POWER



82 OFFICE AIR 2.0



82 OFFICE AIR 2.0 POWER

ROXXANE

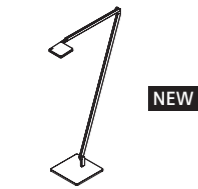

83 ROXXANE HOME



83 ROXXANE OFFICE



83 ROXXANE HOME

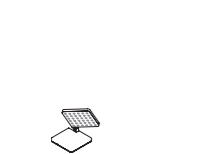

85 ROXXANE FLY CL
CABLELESS LIGHT

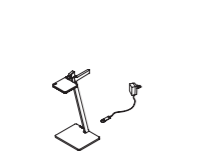

86 ROXXANE LEGGERA 52 CL
CABLELESS LIGHT



86 ROXXANE LEGGERA 101 CL
CABLELESS LIGHT



87 ROXXANE LEGGERA 101 CL
EDITION WALTER KNOLL
CABLELESS LIGHT

WINGLET CL



88 WINGLET CL
CABLELESS LIGHT



88 WINGLET CL SET 3
CABLELESS LIGHT

RIM R



89 RIM R 9



89 RIM R 36



89 RIM R 49

AIR MAXX SUPER POWER



90 AIR MAXX 130 SUPER POWER

NEW



90 AIR MAXX 250 SUPER POWER

NEW

MIKE INDIA



91 MIKE INDIA 50 ACCENT



91 MIKE INDIA 50 ACCENT LONG



91 MIKE INDIA 70 ACCENT

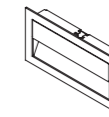

92 MIKE INDIA 70 ACCENT LONG

ZEN ON / ZEN IN



93 ZEN ON

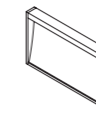

93 ZEN ON LONG



93 ZEN IN S



93 ZEN IN M

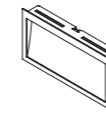

94 ZEN IN M LONG



94 ZEN IN M LONG POWER

LEUCHTEN NACH FAMILIEN / LUMINAIRES BY FAMILIES

LOOX5 LED BÄNDER / LOOX5 LED STRIP LIGHTS



LOOX5 NETZTEILE / LOOX5 POWER SUPPLY UNITS

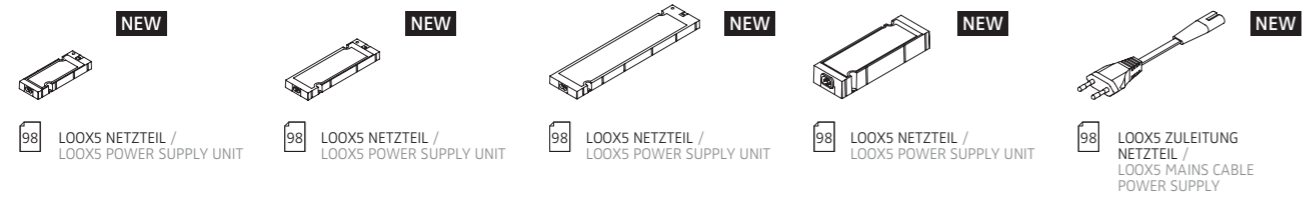

LOOX5 CONNECT MESH / LOOX5 CONNECT MESH

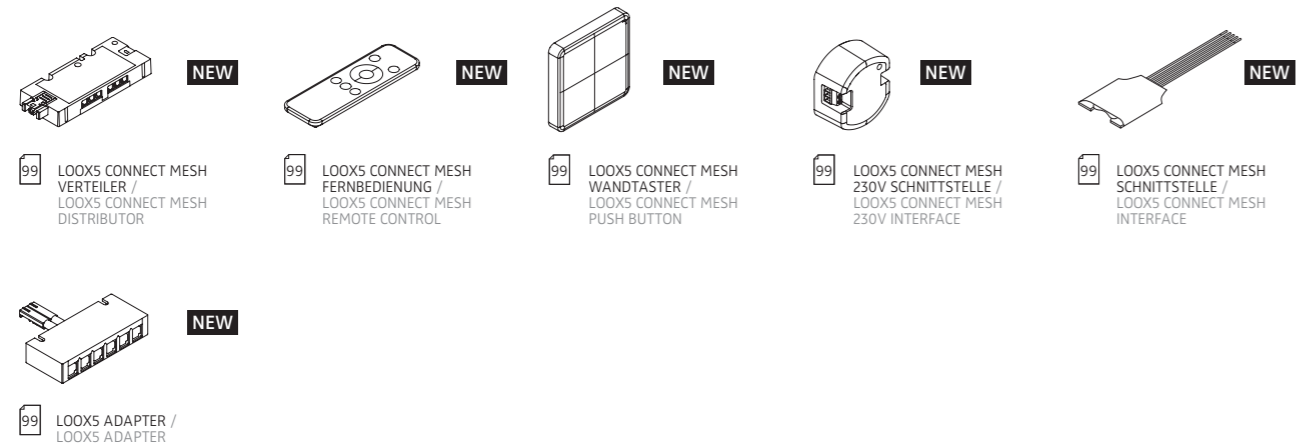

LOOX5 PROFILE / LOOX5 PROFILES

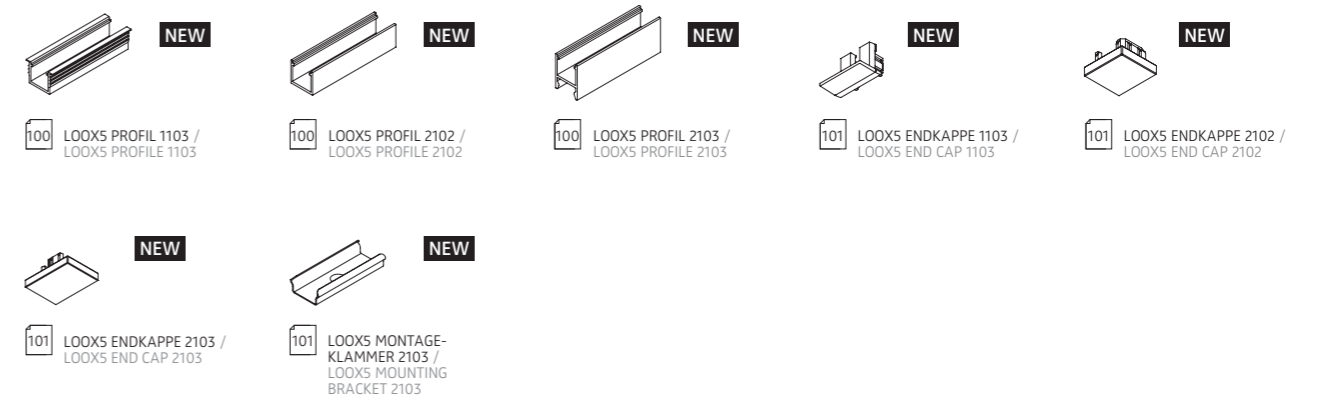

LOOX5 VERTEILER / LOOX5 DISTRIBUTOR

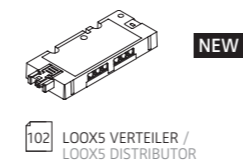

LIGHTING PAD

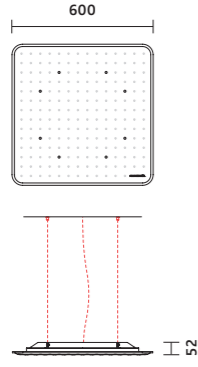
Artikel Article	Maße Dimensions	Technik Technology	Ausführung Version	Art.-Nr. Item no. 2700 K	Art.-Nr. Item no. 3000 K	Art.-Nr. Item no. 4000 K	EUR Netto* EUR net*	EUR Brutto** EUR gross**
LIGHTING PAD Q 600 Schallabsorbierende Akustikleuchte sound-absorbing acoustic luminaire		LED-Technologie LED technology 3,5 kg 27,2 W, 230 V AC ~ 1770 lm IP 20 CRI > 90 Absorptionsklasse B absorption class B	mit Konverter, dimmbar DALI/switchDim, ohne Pendelset und Zuleitung with converter, dimmable DALI/switchDim, without suspension kit and supply cord					
			white	557-499	557-501	557-503	1.305,00	1.552,95
			black ink	560-820	560-823	560-824	1.368,00	1.627,92
			grey dawn	557-475	557-477	557-479	1.305,00	1.552,95
			far mountain	557-469	557-470	557-472	1.368,00	1.627,92
			nightfall	557-483	557-481	557-485	1.368,00	1.627,92
			vineyard	557-493	557-495	557-497	1.368,00	1.627,92
			soft moss	557-487	557-489	557-491	1.368,00	1.627,92
			yellow field	557-505	557-506	557-508	1.368,00	1.627,92

LIGHTING PAD Q 600 Schallabsorbierende Akustikleuchte mit Indirektanteil sound-absorbing acoustic luminaire with additional indirect light		LED-Technologie LED technology 3,5 kg 63,4 W, 230 V AC ~ 5010 lm IP 20 CRI > 90 Absorptionsklasse B absorption class B	mit Konverter, dimmbar DALI/switchDim, ohne Pendelset und Zuleitung with converter, dimmable DALI/switchDim, without suspension kit and supply cord					
			white	557-577	557-502	557-504	1.661,00	1.976,59
			black ink	560-817	560-818	560-819	1.723,00	2.050,37
			grey dawn	557-476	557-478	557-480	1.661,00	1.976,59
			far mountain	557-474	557-471	557-473	1.723,00	2.050,37
			nightfall	557-484	557-482	557-486	1.723,00	2.050,37
			vineyard	557-494	557-496	557-498	1.723,00	2.050,37
			soft moss	557-488	557-490	557-492	1.723,00	2.050,37
			yellow field	557-510	557-507	557-509	1.723,00	2.050,37

Montagezubehör Lighting Pad Q Mounting accessories Lighting Pad Q								
		Pendelset mit 230 V-Zuleitung suspension set with 230 V supply cord	Länge 2 m length 2 m Länge 4 m length 4 m	555-711	555-711	555-711	106,00	126,14

Montagezubehör Lighting Pad Q / R Mounting accessories Lighting Pad Q / R								
		Anschluss-Baldachin 230 V ~ connecting canopy 230 V AC	weiß hochglänzend brilliant white	558-017	558-017	558-017	43,00	51,17

LIGHTING PAD

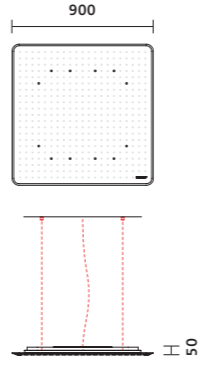
Artikel Article	Maße Dimensions	Technik Technology	Ausführung Version	Art.-Nr. Item no. 2700 K	Art.-Nr. Item no. 3000 K	Art.-Nr. Item no. 4000 K	EUR Netto* EUR net*	EUR Brutto** EUR gross**
LIGHTING PAD Q 900 Schallabsorbierende Akustikleuchte sound-absorbing acoustic luminaire		LED-Technologie LED technology 4,7 kg 38,2 W, 230 V AC ~ 2660 lm IP 20 Absorptionsklasse A absorption class A	mit Konverter, dimmbar DALI/switchDim, ohne Pendelset und Zuleitung with converter, dimmable DALI/switchDim, without suspension kit and supply cord					
			white	555-697	555-698	555-699	1.543,00	1.836,17
			black ink	560-829	560-830	560-831	1.604,00	1.908,76
			grey dawn	555-691	555-692	555-693	1.543,00	1.836,17
			far mountain	556-673	556-384	556-676	1.604,00	1.908,76
			nightfall	556-678	556-385	556-681	1.604,00	1.908,76
			vineyard	556-688	556-387	556-691	1.604,00	1.908,76
			soft moss	556-683	556-386	556-686	1.604,00	1.908,76
			yellow field	556-693	556-388	556-696	1.604,00	1.908,76

LIGHTING PAD Q 900 Schallabsorbierende Akustikleuchte mit Indirektanteil sound-absorbing acoustic luminaire with additional indirect light		LED-Technologie LED technology 4,7 kg 74,4 W, 230 V AC ~ 5900 lm IP 20 Absorptionsklasse A absorption class A	mit Konverter, dimmbar DALI/switchDim, ohne Pendelset und Zuleitung with converter, dimmable DALI/switchDim, without suspension kit and supply cord					
			white	555-700	555-701	555-702	1.898,00	2.258,62
			black ink	560-825	560-826	560-827	1.960,00	2.332,40
			grey dawn	555-694	555-695	555-696	1.898,00	2.258,62
			far mountain	556-674	556-675	556-677	1.960,00	2.332,40
			nightfall	556-679	556-680	556-682	1.960,00	2.332,40
			vineyard	556-689	556-690	556-692	1.960,00	2.332,40
			soft moss	556-684	556-685	556-687	1.960,00	2.332,40
			yellow field	556-694	556-695	556-697	1.960,00	2.332,40

Montagezubehör Lighting Pad Q Mounting accessories Lighting Pad Q								
		Pendelset mit 230 V-Zuleitung suspension set with 230 V supply cord	Länge 2 m length 2 m Länge 4 m length 4 m	555-711	555-711	555-711	106,00	126,14

Montagezubehör Lighting Pad Q / R Mounting accessories Lighting Pad Q / R								
		Anschluss-Baldachin 230 V ~ connecting canopy 230 V AC	weiß hochglänzend brilliant white	558-017	558-017	558-017	43,00	51,17

* Der in der Preisliste ausgewiesene Nettopreis versteht sich zzgl. der gesetzlichen Mehrwertsteuer.
* The net price shown in the price list is without statutory value-added tax.

** Der in der Preisliste ausgewiesene Bruttobetrag versteht sich inkl. der gesetzlichen Mehrwertsteuer.
** The gross price shown in the price list is with statutory value-added tax.

i Nicht enthaltenes Zubehör ist farbig gekennzeichnet.
Accessories not included in delivery are marked in colour.

LIGHTING PAD

Artikel Article	Maße Dimensions	Technik Technology	Ausführung Version	Art.-Nr. Item no. 2700 K	Art.-Nr. Item no. 3000 K	Art.-Nr. Item no. 4000 K	EUR Netto* EUR net*	EUR Brutto** EUR gross**	
LIGHTING PAD R 600 Schallabsorbierende Akustikleuchte sound-absorbing acoustic luminaire		LED-Technologie LED technology 3,5 kg 27,2 W, 230 V AC ~ 1770 lm IP 20 CRI > 90 Absorptionsklasse B absorption class B	mit Konverter, dimmbar DALI/switchDim, ohne Pendelset und Zuleitung with converter, dimmable DALI/switchDim, without suspension kit and supply cord	white	557-541	557-543	557-545	1.305,00	1.552,95
			black ink	560-835	560-836	560-837	1.368,00	1.627,92	
			grey dawn	557-517	557-519	557-521	1.305,00	1.552,95	
			far mountain	557-512	557-513	557-515	1.368,00	1.627,92	
			nightfall	557-523	557-525	557-527	1.368,00	1.627,92	
			vineyard	557-535	557-537	557-539	1.368,00	1.627,92	
			soft moss	557-533	557-529	557-531	1.368,00	1.627,92	
			yellow field	557-547	557-548	557-550	1.368,00	1.627,92	

LIGHTING PAD R 600 Schallabsorbierende Akustikleuchte mit Indirektanteil sound-absorbing acoustic luminaire with additional indirect light		LED-Technologie LED technology 3,5 kg 63,4 W, 230 V AC ~ 5010 lm IP 20 CRI > 90 Absorptionsklasse B absorption class B	mit Konverter, dimmbar DALI/switchDim, ohne Pendelset und Zuleitung with converter, dimmable DALI/switchDim, without suspension kit and supply cord	white	557-542	557-544	557-546	1.661,00	1.976,59
			black ink	560-832	560-833	560-834	1.723,00	2.050,37	
			grey dawn	557-518	557-520	557-522	1.661,00	1.976,59	
			far mountain	557-511	557-514	557-516	1.723,00	2.050,37	
			nightfall	557-524	557-526	557-528	1.723,00	2.050,37	
			vineyard	557-536	557-538	557-540	1.723,00	2.050,37	
			soft moss	557-534	557-530	557-532	1.723,00	2.050,37	
			yellow field	557-552	557-549	557-551	1.723,00	2.050,37	

Montagezubehör Lighting Pad R Mounting accessories Lighting Pad R									
Pendelset mit 230 V-Zuleitung suspension set with 230 V supply cord		Länge 2 m length 2 m	555-713	555-713	555-713	83,00	98,77		
		Länge 4 m length 4 m	555-714	555-714	555-714	91,00	108,29		

Montagezubehör Lighting Pad Q / R Mounting accessories Lighting Pad Q / R									
Anschluss-Baldachin 230 V ~ connecting canopy 230 V AC		weiß hochglänzend brilliant white	558-017	558-017	558-017	43,00	51,17		

LIGHTING PAD

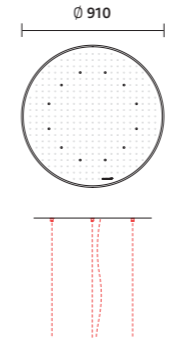
Artikel Article	Maße Dimensions	Technik Technology	Ausführung Version	Art.-Nr. Item no. 2700 K	Art.-Nr. Item no. 3000 K	Art.-Nr. Item no. 4000 K	EUR Netto* EUR net*	EUR Brutto** EUR gross**	
LIGHTING PAD R 900 Schallabsorbierende Akustikleuchte sound-absorbing acoustic luminaire		LED-Technologie LED technology 4,7 kg 38,2 W, 230 V AC ~ 2660 lm IP 20 Absorptionsklasse A absorption class A	mit Konverter, dimmbar DALI/switchDim, ohne Pendelset und Zuleitung with converter, dimmable DALI/switchDim, without suspension kit and supply cord	white	555-685	555-686	555-687	1.543,00	1.836,17
			black ink	560-841	560-842	560-843	1.604,00	1.908,76	
			grey dawn	555-679	555-680	555-681	1.543,00	1.836,17	
			far mountain	556-643	556-645	556-647	1.604,00	1.908,76	
			nightfall	556-649	556-651	556-653	1.604,00	1.908,76	
			vineyard	556-661	556-663	556-665	1.604,00	1.908,76	
			soft moss	556-655	556-657	556-659	1.604,00	1.908,76	
			yellow field	556-667	556-669	556-671	1.604,00	1.908,76	

LIGHTING PAD R 900 Schallabsorbierende Akustikleuchte mit Indirektanteil sound-absorbing acoustic luminaire with additional indirect light		LED-Technologie LED technology 4,7 kg 74,4 W, 230 V AC ~ 5900 lm IP 20 Absorptionsklasse A absorption class A	mit Konverter, dimmbar DALI/switchDim, ohne Pendelset und Zuleitung with converter, dimmable DALI/switchDim, without suspension kit and supply cord	white	555-688	555-689	555-690	1.898,00	2.258,62
			black ink	560-838	560-839	560-840	1.960,00	2.332,40	
			grey dawn	555-682	555-683	555-684	1.898,00	2.258,62	
			far mountain	556-644	556-646	556-648	1.960,00	2.332,40	
			nightfall	556-650	556-652	556-654	1.960,00	2.332,40	
			vineyard	556-662	556-664	556-666	1.960,00	2.332,40	
			soft moss	556-656	556-658	556-660	1.960,00	2.332,40	
			yellow field	556-668	556-670	556-672	1.960,00	2.332,40	

Montagezubehör Lighting Pad R Mounting accessories Lighting Pad R									
Pendelset mit 230 V-Zuleitung suspension set with 230 V supply cord		Länge 2 m length 2 m	555-713	555-713	555-713	83,00	98,77		
		Länge 4 m length 4 m	555-714	555-714	555-714	91,00	108,29		

Montagezubehör Lighting Pad Q / R Mounting accessories Lighting Pad Q / R									
Anschluss-Baldachin 230 V ~ connecting canopy 230 V AC		weiß hochglänzend brilliant white	558-017	558-017	558-017	43,00	51,17		

* Der in der Preisliste ausgewiesene Nettopreis versteht sich zzgl. der gesetzlichen Mehrwertsteuer.

* The net price shown in the price list is without statutory value-added tax.

** Der in der Preisliste ausgewiesene Bruttobetrag versteht sich inkl. der gesetzlichen Mehrwertsteuer.

** The gross price shown in the price list is with statutory value-added tax.

i Nicht enthaltenes Zubehör ist farbig gekennzeichnet.
Accessories not included in delivery are marked in colour.

LIGHTING PAD LOUNGE

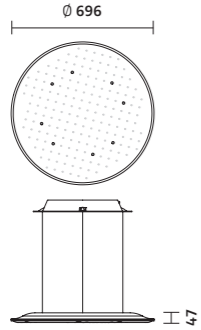
Artikel Article	Maße Dimensions	Technik Technology	Ausführung Version	Art.-Nr. Item no.	Art.-Nr. Item no.	Art.-Nr. Item no.	EUR Netto* EUR net*	EUR Brutto** EUR gross**
				2700 K	3000 K	4000 K		
NEW LIGHTING PAD LOUNGE R 600 VARIO		LED-Technologie LED technology 9,6 kg TW 2700–4000 K ~ 3500 lm 1700 direkt, 1800 indirekt 1700 direct, 1800 indirect 60 W, 230 V AC IP 20 CRI 90 Absorptionsklasse B absorption class B	mit Gestensteuerung / BLE, videokonferenzfähig, beidseitig abstrahlend, stromführende Pendelseile, mit Pendelset und Baldachin inkl. Konverter with gesture control /BLE, capable for video confe- rencing, double-sided, power supply by pendu- lum ropes, with suspen- sion kit and canopy incl. converter Tunable White Tunable White					
			Formholz Santos Palisander shaped wood Santos Rosewood Vlies, black ink fleece, black ink	560-475			3.377,31	4.019,00
			Vlies, weiß fleece, white	560-664			3.377,31	4.019,00
			Vlies, grey dawn fleece, grey dawn	560-869			3.377,31	4.019,00
			Formholz Black Cherry shaped wood Black Cherry Vlies, black ink fleece, black ink	560-476			3.278,15	3.901,00
			Vlies, weiß fleece, white	560-868			3.278,15	3.901,00
			Vlies, grey dawn fleece, grey dawn	560-867			3.278,15	3.901,00
			Formholz Classic Oak shaped wood Classic Oak Vlies, black ink fleece, black ink	560-865			2.581,51	3.072,00
			Vlies, weiß fleece, white	560-866			2.581,51	3.072,00
			Vlies, grey dawn fleece, grey dawn	560-573			2.581,51	3.072,00
			Formholz Ebony Ash shaped wood Ebony Ash Vlies, black ink fleece, black ink	561-302			3.278,15	3.901,00
			Vlies, weiß fleece, white	561-440			3.278,15	3.901,00
			Vlies, grey dawn fleece, grey dawn	561-324			3.278,15	3.901,00

LIGHTING PAD LOUNGE

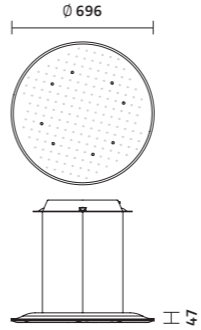
Artikel Article	Maße Dimensions	Technik Technology	Ausführung Version	Art.-Nr. Item no.	Art.-Nr. Item no.	Art.-Nr. Item no.	EUR Netto* EUR net*	EUR Brutto** EUR gross**
				2700 K	3000 K	4000 K		
NEW LIGHTING PAD LOUNGE R 600		LED-Technologie LED technology 8,8 kg TW 2700–4000 K ~ 3500 lm 1700 direkt, 1800 indirekt 1700 direct, 1800 indirect 60 W, 230 V AC IP 20 CRI 90 Absorptionsklasse B absorption class B	mit Gestensteuerung / BLE, videokonferenzfähig, beidseitig abstrahlend, stromführende Pendelseile, mit Pendelset und Baldachin inkl. Konverter with gesture control /BLE, capable for video confe- rencing, double-sided, power supply by pendu- lum ropes, with suspen- sion kit and canopy incl. converter Tunable White Tunable White					
			Formholz Santos Palisander shaped wood Santos Rosewood Vlies, black ink fleece, black ink	560-571			2.781,51	3.310,00
			Vlies, weiß fleece, white	560-665			2.781,51	3.310,00
			Vlies, grey dawn fleece, grey dawn	560-876			2.781,51	3.310,00
			Formholz Black Cherry shaped wood Black Cherry Vlies, black ink fleece, black ink	560-572			2.680,67	3.190,00
			Vlies, weiß fleece, white	560-875			2.680,67	3.190,00
			Vlies, grey dawn fleece, grey dawn	560-873			2.680,67	3.190,00
			Formholz Classic Oak shaped wood Classic Oak Vlies, black ink fleece, black ink	560-871			1.984,87	2.362,00
			Vlies, weiß fleece, white	560-872			1.984,87	2.362,00
			Vlies, grey dawn fleece, grey dawn	560-574			1.984,87	2.362,00
			Formholz Ebony Ash shaped wood Ebony Ash Vlies, black ink fleece, black ink	561-382			2.680,67	3.190,00
			Vlies, weiß fleece, white	561-446			2.680,67	3.190,00
			Vlies, grey dawn fleece, grey dawn	561-444			2.680,67	3.190,00

* Der in der Preisliste ausgewiesene Nettopreis versteht sich zzgl. der gesetzlichen Mehrwertsteuer.

* The net price shown in the price list is without statutory value-added tax.

** Der in der Preisliste ausgewiesene Brutttopreis versteht sich inkl. der gesetzlichen Mehrwertsteuer.

** The gross price shown in the price list is with statutory value-added tax.

Q ONE

Artikel Article	Maße Dimensions	Technik Technology	Ausführung Version	Art.-Nr. Item no. 2700 K	Art.-Nr. Item no. 3000 K	Art.-Nr. Item no. 4000 K	EUR Netto* EUR net*	EUR Brutto** EUR gross**	
Q ONE Wallwasher mit Gehäuse aus Aluminium Wallwasher with housing made of aluminium		LED-Technologie LED technology 330 g 2700 K, 700 lm 3000 K, 730 lm 4000 K, 780 lm 230 V AC 10,8 W CRI > 90 IP 20	inkl. externer Konverter, dimmbar über Phasen-/abschnitt incl. external converter, dimmable via trailing / leading edge dimmer						
				schwarz matt matt black	557-814	557-815	557-816	215,00	255,85
			weiß matt matt white	557-817	557-818	557-819	215,00	255,85	
		LED-Technologie LED technology 330 g 2700 K, 700 lm 3000 K, 730 lm 4000 K, 780 lm 230 V AC 10,3 W CRI > 90 IP 20	inkl. externer Konverter, dimmbar über DALI incl. external converter, dimmable via DALI						
				schwarz matt matt black	557-820	557-821	557-822	268,00	318,92
			weiß matt matt white	557-823	557-824	557-825	268,00	318,92	
Q ONE AUFBAU Wallwasher mit Aufbaugehäuse aus Aluminium Wallwasher with surface-mounted housing made of aluminium		LED-Technologie LED technology 350 g 2700 K, 700 lm 3000 K, 730 lm 4000 K, 780 lm 230 V AC 10,8 W CRI > 90 IP 20	integrierter Konverter, dimmbar über Phasen-/abschnitt integrated converter, dimmable via trailing / leading edge dimmer						
				schwarz matt matt black	557-649	557-650	557-651	215,00	255,85
				weiß matt matt white	557-652	557-653	557-654	215,00	255,85
			integrierter Konverter, dimmbar DALI integrated converter, dimmable via DALI						
			schwarz matt matt black	557-655	557-656	557-657	268,00	318,92	
			weiß matt matt white	557-658	557-659	557-660	268,00	318,92	

Q ONE

Artikel Article	Maße Dimensions	Technik Technology	Ausführung Version	Art.-Nr. Item no. 2700 K	Art.-Nr. Item no. 3000 K	Art.-Nr. Item no. 4000 K	EUR Netto* EUR net*	EUR Brutto** EUR gross**
NEW Q ONE IN Einbau-Wallwasher für Hohlraumbau Recessed wallwasher for cavity mounting		LED-Technologie LED technology 500 g 2700 K, 700 lm 3000 K, 730 lm 4000 K, 780 lm 230 V AC 10,8 W CRI > 90 IP 20	inkl. externer Konverter und Deckeneinbaurahmen, dimmbar über Phasen-/abschnitt incl. external converter and phase control dimmer, dimmable via trailing / leading edge dimmer					
				schwarz matt matt black	560-180	560-181	560-182	209,00
			weiß matt matt white	560-183	560-184	560-185	209,00	248,71
		LED-Technologie LED technology 500 g 2700 K, 700 lm 3000 K, 730 lm 4000 K, 780 lm 230 V AC 10,3 W CRI > 90 IP 20	inkl. externer Konverter und Deckeneinbaurahmen, dimmbar über DALI incl. external converter and recessed ceiling frame, dimmable via DALI					
				schwarz matt matt black	560-186	560-187	560-188	250,00
			weiß matt matt white	560-189	560-190	560-193	250,00	297,50

* Der in der Preisliste ausgewiesene Nettopreis versteht sich zzgl. der gesetzlichen Mehrwertsteuer.

* The net price shown in the price list is without statutory value-added tax.

** Der in der Preisliste ausgewiesene Brutttopreis versteht sich inkl. der gesetzlichen Mehrwertsteuer.

** The gross price shown in the price list is with statutory value-added tax.

Q FOUR

Artikel Article	Maße Dimensions	Technik Technology	Ausführung Version	Art.-Nr. Item no. 2700 K	Art.-Nr. Item no. 3000 K	Art.-Nr. Item no. 4000 K	EUR Netto* EUR net*	EUR Brutto** EUR gross**	
Q FOUR 40° Deckenstrahler mit Gehäuse aus Aluminium Ceiling downlight with housing made of aluminium		LED-Technologie LED technology 330 g 2700 K, 730 lm 3000 K, 800 lm 4000 K, 850 lm 230 V AC 14,4 W CRI > 90 IP 20	inkl. externer Konverter, dimmbar über Phasen-/abschnitt incl. external converter, dimmable via trailing / leading edge dimmer						
				schwarz matt matt black	557-830	557-831	557-832	274,00	326,06
				weiß matt matt white	557-833	557-834	557-835	274,00	326,06
			inkl. externer Konverter, dimmbar über DALI incl. external converter, dimmable via DALI						
				schwarz matt matt black	557-842	557-843	557-844	321,00	381,99
				weiß matt matt white	557-845	557-846	557-847	321,00	381,99
Q FOUR 80° Deckenstrahler mit Gehäuse aus Aluminium Ceiling downlight with housing made of aluminium		LED-Technologie LED technology 330 g 2700 K, 730 lm 3000 K, 800 lm 4000 K, 850 lm 230 V AC 14,4 W CRI > 90 IP 20	inkl. externer Konverter, dimmbar über Phasen-/abschnitt incl. external converter, dimmable via trailing / leading edge dimmer						
				schwarz matt matt black	557-836	557-837	557-838	274,00	326,06
				weiß matt matt white	557-839	557-840	557-841	274,00	326,06
			inkl. externer Konverter, dimmbar über DALI incl. external converter, dimmable via DALI						
				schwarz matt matt black	557-848	557-849	557-850	321,00	381,99
				weiß matt matt white	557-851	557-852	557-853	321,00	381,99

Q FOUR

Artikel Article	Maße Dimensions	Technik Technology	Ausführung Version	Art.-Nr. Item no. 2700 K	Art.-Nr. Item no. 3000 K	Art.-Nr. Item no. 4000 K	EUR Netto* EUR net*	EUR Brutto** EUR gross**	
Q FOUR AUFBAU 40° Deckenstrahler mit Aufbaugeschäule aus Aluminium Ceiling downlight with surface-mounted housing made of aluminium		LED-Technologie LED technology 550 g 2700 K, 600 lm 3000 K, 660 lm 4000 K, 700 lm 230 V AC 11,2 W CRI > 90 IP 20	integrierter Konverter, dimmbar über Phasen-/abschnitt integrated converter, dimmable via trailing / leading edge dimmer						
				schwarz matt matt black	557-862	557-863	557-864	281,00	334,39
				weiß matt matt white	557-865	557-866	557-867	281,00	334,39
			integrierter Konverter, dimmbar DALI integrated converter, dimmable via DALI						
				schwarz matt matt black	557-685	557-686	557-687	334,00	397,46
				weiß matt matt white	557-688	557-689	557-690	334,00	397,46
Q FOUR AUFBAU 80° Deckenstrahler mit Aufbaugeschäule aus Aluminium Ceiling downlight with surface-mounted housing made of aluminium		LED-Technologie LED technology 550 g 2700 K, 600 lm 3000 K, 660 lm 4000 K, 700 lm 230 V AC 11,2 W CRI > 90 IP 20	integrierter Konverter, dimmbar über Phasen-/abschnitt integrated converter, dimmable via trailing / leading edge dimmer						
				schwarz matt matt black	557-868	557-869	557-870	281,00	334,39
				weiß matt matt white	557-871	557-872	557-873	281,00	334,39
			integrierter Konverter, dimmbar DALI integrated converter, dimmable via DALI						
				schwarz matt matt black	557-691	557-692	557-693	334,00	397,46
				weiß matt matt white	557-694	557-695	557-696	334,00	397,46

* Der in der Preisliste ausgewiesene Nettopreis versteht sich zzgl. der gesetzlichen Mehrwertsteuer.

* The net price shown in the price list is without statutory value-added tax.

** Der in der Preisliste ausgewiesene Brutttopreis versteht sich inkl. der gesetzlichen Mehrwertsteuer.

** The gross price shown in the price list is with statutory value-added tax.

Q FOUR

Artikel Article	Maße Dimensions	Technik Technology	Ausführung Version	Art.-Nr. Item no. 2700 K	Art.-Nr. Item no. 3000 K	Art.-Nr. Item no. 4000 K	EUR Netto* EUR net*	EUR Brutto** EUR gross**
NEW Q FOUR IN 40° Deckeneinbaustrahler Hohlraumbau Recessed ceiling spot, cavity mounting		LED-Technologie LED technology 550 g 2700 K, 730 lm 3000 K, 800 lm 4000 K, 850 lm 230 V AC 14,4 W CRI > 90 IP 20	inkl. externer Konverter und Deckeneinbaurahmen, dimmbär über Phasen-/abschnitt incl. external converter and recessed ceiling frame, dimmable via trailing / leading edge dimmer					
				schwarz matt matt black weiß matt matt white	560-197	560-198	560-199	262,00
		LED-Technologie LED technology 550 g 2700 K, 820 lm 3000 K, 900 lm 4000 K, 960 lm 230 V AC 16,4 W CRI > 90 IP 20	inkl. externer Konverter und Deckeneinbaurahmen, dimmbär über DALI incl. external converter and recessed ceiling frame, dimmable via DALI					
				schwarz matt matt black weiß matt matt white	560-209	560-218	560-211	316,00
		LED-Technologie LED technology 550 g 2700 K, 820 lm 3000 K, 900 lm 4000 K, 960 lm 230 V AC 16,4 W CRI > 90 IP 20	inkl. externer Konverter und Deckeneinbaurahmen, dimmbär über DALI incl. external converter and recessed ceiling frame, dimmable via DALI					
				schwarz matt matt black weiß matt matt white	560-206	560-207	560-208	316,00
NEW Q FOUR IN 80° Deckeneinbaustrahler Hohlraumbau Recessed ceiling spot, cavity mounting		LED-Technologie LED technology 550 g 2700 K, 730 lm 3000 K, 800 lm 4000 K, 850 lm 230 V AC 14,4 W CRI > 90 IP 20	inkl. externer Konverter und Deckeneinbaurahmen, dimmbär über Phasen-/abschnitt incl. external converter and recessed ceiling frame, dimmable via trailing / leading edge dimmer					
				schwarz matt matt black weiß matt matt white	560-203	560-204	560-205	262,00
		LED-Technologie LED technology 550 g 2700 K, 820 lm 3000 K, 900 lm 4000 K, 960 lm 230 V AC 16,4 W CRI > 90 IP 20	inkl. externer Konverter und Deckeneinbaurahmen, dimmbär über DALI incl. external converter and recessed ceiling frame, dimmable via DALI					
				schwarz matt matt black weiß matt matt white	560-200	560-201	560-202	262,00
		LED-Technologie LED technology 550 g 2700 K, 820 lm 3000 K, 900 lm 4000 K, 960 lm 230 V AC 16,4 W CRI > 90 IP 20	inkl. externer Konverter und Deckeneinbaurahmen, dimmbär über DALI incl. external converter and recessed ceiling frame, dimmable via DALI					
				schwarz matt matt black weiß matt matt white	560-215	560-216	560-219	316,00
		LED-Technologie LED technology 550 g 2700 K, 820 lm 3000 K, 900 lm 4000 K, 960 lm 230 V AC 16,4 W CRI > 90 IP 20	inkl. externer Konverter und Deckeneinbaurahmen, dimmbär über DALI incl. external converter and recessed ceiling frame, dimmable via DALI					
				schwarz matt matt black weiß matt matt white	560-212	560-213	560-214	316,00

Q FOUR

Artikel Article	Maße Dimensions	Technik Technology	Ausführung Version	Art.-Nr. Item no. 2700 K	Art.-Nr. Item no. 3000 K	Art.-Nr. Item no. 4000 K	EUR Netto* EUR net*	EUR Brutto** EUR gross**
NEW Q FOUR TT 40° Deckenstrahler, dreh- und schwenkbar Ceiling spot, rotatable and tiltable		LED-Technologie LED technology 520 g 2700 K, 730 lm 3000 K, 800 lm 4000 K, 850 lm 230 V AC 14,4 W CRI > 90 IP 20	inkl. externer Konverter, dimmbär über Phasen-/abschnitt incl. external converter, dimmable via trailing / leading edge dimmer					
				schwarz matt matt black weiß matt matt white	557-874	557-876	557-878	356,00
		LED-Technologie LED technology 520 g 2700 K, 820 lm 3000 K, 900 lm 4000 K, 960 lm 230 V AC 16,4 W CRI > 90 IP 20	inkl. externer Konverter, dimmbär über DALI incl. external converter, dimmable via DALI					
				schwarz matt matt black weiß matt matt white	557-889	557-890	557-891	427,00
		LED-Technologie LED technology 520 g 2700 K, 820 lm 3000 K, 900 lm 4000 K, 960 lm 230 V AC 16,4 W CRI > 90 IP 20	inkl. externer Konverter, dimmbär über DALI incl. external converter, dimmable via DALI					
				schwarz matt matt black weiß matt matt white	557-892	557-893	557-894	427,00
NEW Q FOUR TT 80° Deckenstrahler, dreh- und schwenkbar Ceiling spot, rotatable and tiltable		LED-Technologie LED technology 520 g 2700 K, 730 lm 3000 K, 800 lm 4000 K, 850 lm 230 V AC 14,4 W CRI > 90 IP 20	inkl. externer Konverter, dimmbär über Phasen-/abschnitt incl. external converter, dimmable via trailing / leading edge dimmer					
				schwarz matt matt black weiß matt matt white	557-883	557-884	557-885	356,00
		LED-Technologie LED technology 520 g 2700 K, 820 lm 3000 K, 900 lm 4000 K, 960 lm 230 V AC 16,4 W CRI > 90 IP 20	inkl. externer Konverter, dimmbär über DALI incl. external converter, dimmable via DALI					
				schwarz matt matt black weiß matt matt white	557-886	557-887	557-888	356,00
		LED-Technologie LED technology 520 g 2700 K, 820 lm 3000 K, 900 lm 4000 K, 960 lm 230 V AC 16,4 W CRI > 90 IP 20	inkl. externer Konverter, dimmbär über DALI incl. external converter, dimmable via DALI					
				schwarz matt matt black weiß matt matt white	557-895	557-896	557-897	427,00
		LED-Technologie LED technology 520 g 2700 K, 820 lm 3000 K, 900 lm 4000 K, 960 lm 230 V AC 16,4 W CRI > 90 IP 20	inkl. externer Konverter, dimmbär über DALI incl. external converter, dimmable via DALI					
				schwarz matt matt black weiß matt matt white	557-898	557-899	557-900	427,00

* Der in der Preisliste ausgewiesene Nettopreis versteht sich zzgl. der gesetzlichen Mehrwertsteuer.

* The net price shown in the price list is without statutory value-added tax.

** Der in der Preisliste ausgewiesene Bruttobetrag versteht sich inkl. der gesetzlichen Mehrwertsteuer.

** The gross price shown in the price list is with statutory value-added tax.

Q FOUR

Artikel Article	Maße Dimensions	Technik Technology	Ausführung Version	Art.-Nr. Item no. 2700 K	Art.-Nr. Item no. 3000 K	Art.-Nr. Item no. 4000 K	EUR Netto* EUR net**	EUR Brutto** EUR gross**
NEW Q FOUR TT AUFBAU 40° Deckenstrahler mit Aufbaugehäuse, dreh- und schwenkbar Spot with surface-mounted housing, rotatable and tiltable		LED-Technologie LED technology 820 g 2700 K, 600 lm 3000 K, 660 lm 4000 K, 700 lm 230 V AC 11,2 W CRI > 90 IP 20	integrierter Konverter, dimmbar über Phasen-/abschnitt integrated converter, dimmable via trailing / leading edge dimmer					
			schwarz matt matt black	557-909	557-910	557-911	375,00	446,25
			weiß matt matt white	557-912	557-913	557-914	375,00	446,25
			integrierter Konverter, dimmbar DALI integrated converter, dimmable via DALI					
			schwarz matt matt black	557-725	557-726	557-727	449,00	534,31
			weiß matt matt white	557-728	557-729	557-730	449,00	534,31
NEW Q FOUR TT AUFBAU 80° Deckenstrahler mit Aufbaugehäuse, dreh- und schwenkbar Spot with surface-mounted housing, rotatable and tiltable		LED-Technologie LED technology 820 g 2700 K, 600 lm 3000 K, 660 lm 4000 K, 700 lm 230 V AC 11,2 W CRI > 90 IP 20	integrierter Konverter, dimmbar über Phasen-/abschnitt integrated converter, dimmable via trailing / leading edge dimmer					
			schwarz matt matt black	557-915	557-916	557-917	375,00	446,25
			weiß matt matt white	557-918	557-919	557-920	375,00	446,25
			integrierter Konverter, dimmbar DALI integrated converter, dimmable via DALI					
			schwarz matt matt black	557-731	557-732	557-733	449,00	534,31
			weiß matt matt white	557-734	557-735	557-736	449,00	534,31

Q FOUR

Artikel Article	Maße Dimensions	Technik Technology	Ausführung Version	Art.-Nr. Item no. 2700 K	Art.-Nr. Item no. 3000 K	Art.-Nr. Item no. 4000 K	EUR Netto* EUR net**	EUR Brutto** EUR gross**	
NEW Q FOUR TT TRACK 40° Stromschienenstrahler, dreh- und schwenkbar, für 3-Phasen-Stromschiene Track spotlight, rotatable and tiltable, for 3-phase track		LED-Technologie LED technology 550 g 2700 K, 820 lm 3000 K, 900 lm 4000 K, 960 lm 230 V AC 16,4 W CRI 90 IP 20	integrierter Konverter, dimmbar über DALI integrated converter, dimmable via DALI						
			schwarz matt matt black	560-487	560-488	560-489	464,00	552,16	
			weiß matt matt white	560-490	560-491	560-492	464,00	552,16	
			LED-Technologie LED technology 550 g 2700 K, 820 lm 3000 K, 900 lm 4000 K, 960 lm 230 V AC 16,4 W CRI 90 IP 20	einfach schaltbar, switchable					
			schwarz matt matt black	560-499	560-500	560-501	393,00	467,67	
			weiß matt matt white	560-502	560-503	560-504	393,00	467,67	
NEW Q FOUR TT TRACK 80° Stromschienenstrahler, dreh- und schwenkbar, für 3-Phasen-Stromschiene Track spotlight, rotatable and tiltable, for 3-phase track		LED-Technologie LED technology 550 g 2700 K, 820 lm 3000 K, 900 lm 4000 K, 960 lm 230 V AC 16,4 W CRI 90 IP 20	integrierter Konverter, dimmbar über DALI integrated converter, dimmable via DALI						
			schwarz matt matt black	560-493	560-494	560-495	464,00	552,16	
			weiß matt matt white	560-496	560-497	560-498	464,00	552,16	
			LED-Technologie LED technology 550 g 2700 K, 820 lm 3000 K, 900 lm 4000 K, 960 lm 230 V AC 16,4 W CRI 90 IP 20	einfach schaltbar, switchable					
			schwarz matt matt black	560-505	560-506	560-507	393,00	467,67	
			weiß matt matt white	560-508	560-509	560-510	393,00	467,67	

* Der in der Preisliste ausgewiesene Nettopreis versteht sich zzgl. der gesetzlichen Mehrwertsteuer.

** The net price shown in the price list is without statutory value-added tax.







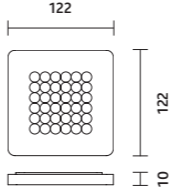

** Der in der Preisliste ausgewiesene Brutttopreis versteht sich inkl. der gesetzlichen Mehrwertsteuer.

** The gross price shown in the price list is with statutory value-added tax.

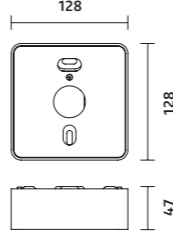
MODUL Q

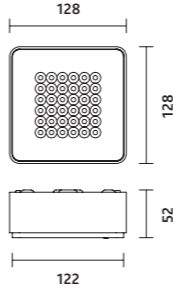
Artikel Article	Maße Dimensions	Technik Technology	Ausführung Version	Art.-Nr. Item no. 2700 K	Art.-Nr. Item no. 3000 K	Art.-Nr. Item no. 4000 K	EUR Netto* EUR net*	EUR Brutto** EUR gross**
MODUL Q 9 Deckenleuchte für Direktmontage Ceiling luminaire for direct mounting		LED-Technologie LED technology 115 g 2700 K, 2,9 W 3000 K, 2,7 W 4000 K, 2,6 W 24 V DC ~ 190 lm IP 20 CRI > 90	ohne Konverter without converter	010-086	004-178	010-087	119,00	141,61
MODUL Q 9 AQUA Deckenleuchte für Direktmontage Ceiling luminaire for direct mounting		LED-Technologie LED technology 115 g 2700 K, 2,9 W 3000 K, 2,7 W 24 V DC ~ 190 lm IP 44 CRI > 90	ohne Konverter without converter	010-088	004-785		148,00	176,12

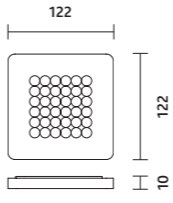
MODUL Q

Artikel Article	Maße Dimensions	Technik Technology	Ausführung Version	Art.-Nr. Item no. 2700 K	Art.-Nr. Item no. 3000 K	Art.-Nr. Item no. 4000 K	EUR Netto* EUR net*	EUR Brutto** EUR gross**
MODUL Q 36 Deckenleuchte für Direktmontage Ceiling luminaire for direct mounting		LED-Technologie LED technology 280 g 2700 K, 7,1 W 3000 K, 6,8 W 4000 K, 6,5 W 24 V DC ~ 750 lm IP 20 CRI > 90	ohne Konverter without converter	009-979	004-155	009-980	213,00	253,47
								Auf Anfrage mit IQ SENSOR Upon request with IQ SENSOR
Deckenleuchte für Hohlraumbau Ceiling luminaire for cavity mounting		LED-Technologie LED technology 280 g 2700 K, 7,1 W 3000 K, 6,8 W 4000 K, 6,5 W 24 V DC ~ 750 lm IP 20 CRI > 90	ohne Konverter without converter	009-983	004-189	009-984	226,00	268,94
FRAME 36 Aufbaugeschäule aus Aluminium, für Modul Q 36 / CUBIC 36 Leuchtenkopf surface-mounted frame made of aluminium, for Modul Q 36 / Cubic 36 luminaire head		700 g 230 V AC / 50 Hz, sek. 24 V DC / 15 W IP 20	integrierter Konverter, dimmbar über Phasenan-/abschnitt, integrated converter, dimmable via trailing / leading edge dimmer					
				557-806	557-806	557-806	162,00	192,78
			schwarz matt matt black weiß matt matt white	557-807	557-807	557-807	162,00	192,78
MODUL Q 36 FRAME Deckenleuchte mit Aufbaugeschäule aus Aluminium Ceiling luminaire with surface-mounted frame made of aluminium		LED-Technologie LED technology 860 g 2700 K, 9,9 W 3000 K, 9,6 W 4000 K, 9,2 W 230 V AC ~ 750 lm IP 20 CRI > 90	integrierter Konverter, dimmbar über Phasenan-/abschnitt, integrated converter, dimmable via trailing / leading edge dimmer					
				557-794	557-795	557-796	361,00	429,59
			schwarz matt matt black weiß matt matt white	557-797	557-798	557-799	361,00	429,59
MODUL Q 36 AQUA Deckenleuchte für Direktmontage Ceiling luminaire for direct mounting		LED-Technologie LED technology 276 g 2700 K, 7,1 W 3000 K, 6,8 W 24 V DC ~ 750 lm IP 44 CRI > 90	ohne Konverter without converter	009-981	004-185		292,00	347,48
Deckenleuchte für Hohlraumbau Ceiling luminaire for cavity mounting		LED-Technologie LED technology 286 g 2700 K, 7,1 W 3000 K, 6,8 W 24 V DC ~ 750 lm IP 44 CRI > 90	ohne Konverter without converter	010-035	007-497		313,00	372,47

* Der in der Preisliste ausgewiesene Nettopreis versteht sich zzgl. der gesetzlichen Mehrwertsteuer.

* The net price shown in the price list is without statutory value-added tax.

** Der in der Preisliste ausgewiesene Bruttobetrag versteht sich inkl. der gesetzlichen Mehrwertsteuer.

** The gross price shown in the price list is with statutory value-added tax.



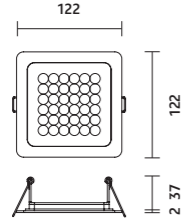
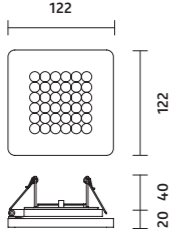
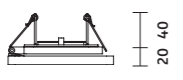
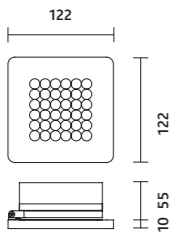
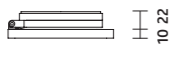



MODUL Q

Artikel Article	Maße Dimensions	Technik Technology	Ausführung Version	Art.-Nr. Item no. 2700 K	Art.-Nr. Item no. 3000 K	Art.-Nr. Item no. 4000 K	EUR Netto* EUR net*	EUR Brutto** EUR gross**
MODUL Q 36 IN Deckenleuchte für Hohlraumbau Ceiling luminaire for cavity mounting		LED-Technologie LED technology 242 g 2700 K, 7,1 W 3000 K, 6,8 W 4000 K, 6,5 W 24 V DC ~ 750 lm IP 20 CRI > 90	ohne Konverter without converter Edelstahl gebürstet brushed stainless steel silber-eloxalfarben anodised silver weiß hochglänzend brilliant white	009-985	004-790	009-986	218,00	259,42
Beton-Einbaudose Concrete mounting box				005-365	005-365	005-365	108,00	128,52
MODUL Q 36 TT Deckenleuchte für Hohlraumbau Ceiling luminaire for cavity mounting		LED-Technologie LED technology 487 g 2700 K, 7,1 W 3000 K, 6,8 W 4000 K, 6,5 W 24 V DC ~ 750 lm IP 20 CRI > 90	ohne Konverter without converter weiß lackiert white varnished silber-eloxalfarben anodised silver	009-996	004-870	009-997	329,00	391,51
Deckenleuchte für Beton-Einbaudose HaloX-0 mit Frontteil Ceiling luminaire for concrete mounting box HaloX-0 with front		LED-Technologie LED technology 487 g 2700 K, 7,1 W 3000 K, 6,8 W 4000 K, 6,5 W 24 V DC ~ 750 lm IP 20 CRI > 90	ohne Konverter without converter weiß lackiert white varnished silber-eloxalfarben anodised silver	010-015	005-226	010-016	329,00	391,51
MODUL Q 36 TT Deckenleuchte mit Aufbaugehäuse 55 mm Ceiling luminaire with surface-mounted housing 55 mm		LED-Technologie LED technology 670 g 2700 K, 8,7 W 3000 K, 8,3 W 4000 K, 7,9 W 230 V AC ~ 750 lm IP 20 CRI > 90	mit Konverter with converter weiß lackiert white varnished silber-eloxalfarben anodised silver	010-033	005-694	010-034	537,00	639,03
Deckenleuchte mit Aufbaugehäuse 22 mm Ceiling luminaire with surface-mounted housing 22 mm		LED-Technologie LED technology 365 g 2700 K, 7,1 W 3000 K, 6,8 W 4000 K, 6,5 W 24 V DC ~ 750 lm IP 20 CRI > 90	ohne Konverter without converter weiß lackiert white varnished silber-eloxalfarben anodised silver	010-025	005-690	010-026	426,00	506,94
				010-023	005-689	010-024	426,00	506,94

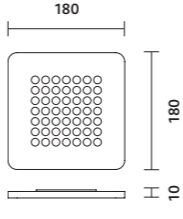
* Der in der Preisliste ausgewiesene Nettopreis versteht sich zzgl. der gesetzlichen Mehrwertsteuer.
* The net price shown in the price list is without statutory value-added tax.

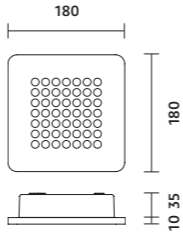

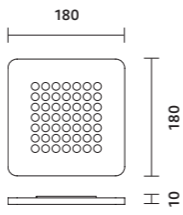
** Der in der Preisliste ausgewiesene Bruttobetrag versteht sich inkl. der gesetzlichen Mehrwertsteuer.
** The gross price shown in the price list is with statutory value-added tax.

MODUL Q

Artikel Article	Maße Dimensions	Technik Technology	Ausführung Version	Art.-Nr. Item no. 2700 K	Art.-Nr. Item no. 3000 K	Art.-Nr. Item no. 4000 K	EUR Netto* EUR net*	EUR Brutto** EUR gross**
MODUL Q 49 Deckenleuchte für Direktmontage Ceiling luminaire for direct mounting		LED-Technologie LED technology 480 g 2700 K, 10,3 W 3000 K, 9,8 W 4000 K, 9,3 W 24 V DC ~ 1050 lm IP 20 CRI > 90	ohne Konverter without converter	010-041	006-143	010-058	283,00	336,77
Deckenleuchte für Hohlraumbau Ceiling luminaire for cavity mounting		LED-Technologie LED technology 492 g 2700 K, 10,3 W 3000 K, 9,8 W 4000 K, 9,3 W 24 V DC ~ 1050 lm IP 20 CRI > 90	ohne Konverter without converter	010-060	006-350	010-061	298,00	354,62
MODUL Q 49 Deckenleuchte mit Aufbaugehäuse 35 mm Ceiling luminaire with surface-mounted housing 35 mm		LED-Technologie LED technology 776 g 2700 K, 12,4 W 3000 K, 11,8 W 4000 K, 11,2 W 230 V AC ~ 1050 lm IP 20 CRI > 90	mit Konverter with converter	010-064¹	006-352¹	010-065¹	396,00	471,24
				Auf Anfrage mit  Upon request with ZigBee Certified product				
		LED-Technologie LED technology 776 g 2700 K, 12,5 W 3000 K, 11,9 W 4000 K, 11,4 W 230 V AC ~ 1050 lm IP 20 CRI > 90	dimmbar, CASAMBI dimmable, CASAMBI mit Konverter und Dimmer with converter and dimmer	547-570	547-564	547-572	598,00	711,62
		LED-Technologie LED technology 776 g 2700 K, 12,5 W 3000 K, 11,9 W 24 V DC ~ 1050 lm IP 20 CRI > 90	dimmbar, IQ Sensor dimmable, IQ Sensor mit Konverter with converter	554-922	554-923		580,00	690,20
MODUL Q 49 AQUA Deckenleuchte für Direktmontage Ceiling luminaire for direct mounting		LED-Technologie LED technology 472 g 2700 K, 10,3 W 3000 K, 9,8 W 24 V DC ~ 1050 lm IP 44 CRI > 90	ohne Konverter without converter	010-062	006-351		319,00	379,61
Deckenleuchte für Hohlraumbau Ceiling luminaire for cavity mounting		LED-Technologie LED technology 485 g 2700 K, 10,3 W 3000 K, 9,8 W 24 V DC ~ 1050 lm IP 44 CRI > 90	ohne Konverter without converter	010-066	007-453		334,00	397,46

¹ Dieses Produkt ist auf Anfrage mit ZigBee und ZigBee mit PDLS (Präsenz- und Umgebungslichtsensorik) erhältlich. Informationen ab Seite 21.
¹ Upon request this product is available with ZigBee and ZigBee with PDLS (presence detector and ambient light sensor). Information from page 21.

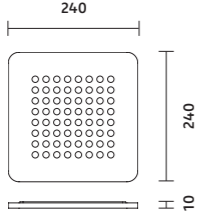
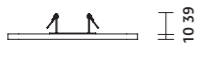
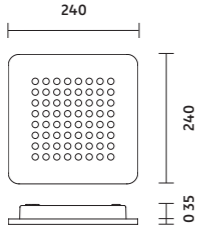
MODUL Q

Artikel Article	Maße Dimensions	Technik Technology	Ausführung Version	Art.-Nr. Item no. 2700 K	Art.-Nr. Item no. 3000 K	Art.-Nr. Item no. 4000 K	EUR Netto* EUR net*	EUR Brutto** EUR gross**
MODUL Q 64 Deckenleuchte für Direktmontage Ceiling luminaire for direct mounting		LED-Technologie LED technology 800 g 2700 K, 11,5 W 3000 K, 10,9 W 4000 K, 10,5 W 24 V DC ~ 1350 lm IP 20 CRI > 90	ohne Konverter without converter	010-073	004-180	010-074	417,00	496,23
Deckenleuchte für Hohlraumbau Ceiling luminaire for cavity mounting		LED-Technologie LED technology 813 g 2700 K, 11,5 W 3000 K, 10,9 W 4000 K, 10,5 W 24 V DC ~ 1350 lm IP 20 CRI > 90	ohne Konverter without converter	010-090	004-191	010-091	433,00	515,27
MODUL Q 64 Deckenleuchte mit Aufbaugehäuse 35 mm Ceiling luminaire with surface-mounted housing 35 mm		LED-Technologie LED technology 948 g 2700 K, 13,6 W 3000 K, 12,9 W 4000 K, 12,5 W 230 V AC ~ 1350 lm IP 20 CRI > 90	mit Konverter with converter	010-068¹	003-727¹	010-069¹	567,00	674,73
				Auf Anfrage mit Upon request with 				
		LED-Technologie LED technology 948 g 2700 K, 13,7 W 3000 K, 13 W 4000 K, 12,6 W 230 V AC ~ 1350 lm IP 20 CRI > 90	dimmbar, CASAMBI dimmable, CASAMBI mit Konverter und Dimmer with converter and dimmer	547-584	547-583	547-585	769,00	915,11
		LED-Technologie LED technology 948 g 3000 K, 13 W 24 V DC ~ 1350 lm IP 20 CRI > 90	dimmbar, IQ Sensor dimmable, IQ Sensor mit Konverter with converter		554-926		751,00	893,69

MODUL Q

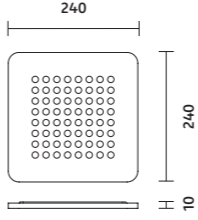
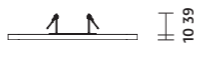
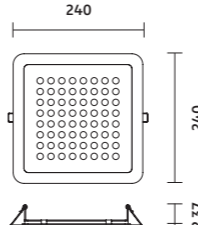
Artikel Article	Maße Dimensions	Technik Technology	Ausführung Version	Art.-Nr. Item no. 2700 K	Art.-Nr. Item no. 3000 K	Art.-Nr. Item no. 4000 K	EUR Netto* EUR net*	EUR Brutto** EUR gross**
MODUL Q 64 AQUA Deckenleuchte für Direktmontage Ceiling luminaire for direct mounting		LED-Technologie LED technology 800 g 2700 K, 11,5 W 3000 K, 10,9 W 24 V DC ~ 1350 lm IP 44 CRI > 90	ohne Konverter without converter	010-075	004-258		463,00	550,97
Deckenleuchte für Hohlraumbau Ceiling luminaire for cavity mounting		LED-Technologie LED technology 813 g 2700 K, 11,5 W 3000 K, 10,9 W 24 V DC ~ 1350 lm IP 44 CRI > 90	ohne Konverter without converter	010-084	007-478		477,00	567,63
MODUL Q 64 IN Deckenleuchte für Hohlraumbau Ceiling luminaire for cavity mounting		LED-Technologie LED technology 873 g 2700 K, 11,5 W 3000 K, 10,9 W 4000 K, 10,5 W 24 V DC ~ 1350 lm IP 20 CRI > 90	ohne Konverter without converter					
			Edelstahl gebürstet brushed stainless steel	010-078	004-873	010-079	448,00	533,12
			silber-eloxalfarben anodised silver	010-080	004-875	010-081	433,00	515,27
			weiß hochglänzend brilliant white	010-082	004-876	010-083	433,00	515,27
Beton-Einbaudose Concrete mounting box				005-366	005-366	005-366	121,00	143,99

* Der in der Preisliste ausgewiesene Nettopreis versteht sich zzgl. der gesetzlichen Mehrwertsteuer.
* The net price shown in the price list is without statutory value-added tax.

** Der in der Preisliste ausgewiesene Bruttobetrag versteht sich inkl. der gesetzlichen Mehrwertsteuer.
** The gross price shown in the price list is with statutory value-added tax.

¹ Dieses Produkt ist auf Anfrage mit ZigBee und ZigBee mit PDLS (Präsenz- und Umgebungslichtsensorik) erhältlich. Informationen ab Seite 21.
¹ Upon request this product is available with ZigBee and ZigBee with PDLS (presence detector and ambient light sensor). Information from page 21.

MODUL Q

Artikel Article	Maße Dimensions	Technik Technology	Ausführung Version	Art.-Nr. Item no. 2700 K	Art.-Nr. Item no. 3000 K	Art.-Nr. Item no. 4000 K	EUR Netto* EUR net*	EUR Brutto** EUR gross**
MODUL Q 100 Deckenleuchte für Direktmontage Ceiling luminaire for direct mounting		LED-Technologie LED technology 1350 g 2700 K, 19 W 3000 K, 18,1 W 4000 K, 17,3 W 24 V DC ~ 2150 lm IP 20 CRI > 90	ohne Konverter without converter	009-944	006-339	009-945	539,00	641,41
Deckenleuchte für Hohlraumbau Ceiling luminaire for cavity mounting		LED-Technologie LED technology 1503 g 2700 K, 19 W 3000 K, 18,1 W 4000 K, 17,3 W 24 V DC ~ 2150 lm IP 20 CRI > 90	ohne Konverter without converter	009-946	006-436	009-947	566,00	673,54
MODUL Q 100 Deckenleuchte mit Aufbaugeschäube 35 mm Ceiling luminaire with surface-mounted housing 35 mm		LED-Technologie LED technology 1603 g 2700 K, 22,5 W 3000 K, 21,5 W 4000 K, 20,5 W 230 V AC ~ 2150 lm IP 20 CRI > 90	mit Konverter with converter	009-948¹	006-437¹	009-949¹	623,00	741,37
				Auf Anfrage mit Upon request with				
		LED-Technologie LED technology 1603 g 2700 K, 22,6 W 3000 K, 21,6 W 4000 K, 20,6 W 230 V AC ~ 2150 lm IP 20 CRI > 90	dimmbar, CASAMBI dimmable, CASAMBI mit Konverter und Dimmer with converter and dimmer	547-603	547-602	547-604	824,00	980,56
		LED-Technologie LED technology 1338 g 2700 K, 19 W 3000 K, 18,1 W 4000 K, 17,3 W 24 V DC ~ 2150 lm IP 20 CRI > 90	ohne Konverter without converter	009-950	006-438	009-951	580,00	690,20
MODUL Q 100 AQUA Deckenleuchte für Direktmontage Ceiling luminaire for direct mounting		LED-Technologie LED technology 1350 g 2700 K, 19 W 3000 K, 18,1 W 24 V DC ~ 2150 lm IP 44 CRI > 90	ohne Konverter without converter	544-929	009-565		578,00	687,82
Deckenleuchte für Hohlraumbau Ceiling luminaire for cavity mounting		LED-Technologie LED technology 1503 g 2700 K, 19 W 3000 K, 18,1 W 24 V DC ~ 2150 lm IP 44 CRI > 90	ohne Konverter without converter	544-931	008-480		598,00	711,62

* Der in der Preisliste ausgewiesene Nettopreis versteht sich zzgl. der gesetzlichen Mehrwertsteuer.
* The net price shown in the price list is without statutory value-added tax.

** Der in der Preisliste ausgewiesene Bruttobetrag versteht sich inkl. der gesetzlichen Mehrwertsteuer.
** The gross price shown in the price list is with statutory value-added tax.

MODUL Q

Artikel Article	Maße Dimensions	Technik Technology	Ausführung Version	Art.-Nr. Item no. 2700 K	Art.-Nr. Item no. 3000 K	Art.-Nr. Item no. 4000 K	EUR Netto* EUR net*	EUR Brutto** EUR gross**
MODUL Q 144 Deckenleuchte für Direktmontage Ceiling luminaire for direct mounting		LED-Technologie LED technology 1643 g 3000 K, 24,4 W 4000 K, 23,3 W 24 V DC ~ 3000 lm IP 20 CRI > 90	ohne Konverter without converter		004-886	009-954	738,00	878,22
Deckenleuchte für Hohlraumbau Ceiling luminaire for cavity mounting		LED-Technologie LED technology 1797 g 3000 K, 24,4 W 4000 K, 23,3 W 24 V DC ~ 3000 lm IP 20 CRI > 90	ohne Konverter without converter		005-471	009-964	765,00	910,35
MODUL Q 144 Deckenleuchte mit Aufbaugeschäube 35 mm Ceiling luminaire with surface-mounted housing 35 mm		LED-Technologie LED technology 2340 g 3000 K, 28,3 W 4000 K, 27,1 W 230 V AC ~ 3000 lm IP 20 CRI > 90	mit Konverter with converter		005-442¹	009-956¹	990,00	1.178,10
				Auf Anfrage mit Upon request with				
		LED-Technologie LED technology 2340 g 3000 K, 28,4 W 4000 K, 27,2 W 230 V AC ~ 3000 lm IP 20 CRI > 90	mit Konverter und Dimmer, 1–10 V with converter and dimmer, 1–10 V		005-678	009-966	1.117,00	1.329,23
		LED-Technologie LED technology 2340 g 3000 K, 28,9 W 4000 K, 27,8 W 230 V AC ~ 3000 lm IP 20 CRI > 90	mit Konverter und Dimmer DALI/switch-Dim with converter and dimmer DALI/switch-Dim		005-679	009-968	1.166,00	1.387,54
		LED-Technologie LED technology 2340 g 3000 K, 28,4 W 4000 K, 27,2 W 230 V AC ~ 3000 lm IP 20 CRI > 90	dimmbar, CASAMBI dimmable, CASAMBI mit Konverter und Dimmer with converter and dimmer		547-606	547-608	1.192,00	1.418,48
		LED-Technologie LED technology 1707 g 3000 K, 24,4 W 4000 K, 23,3 W 24 V DC ~ 3000 lm IP 20 CRI > 90	ohne Konverter without converter		005-443	009-961	786,00	935,34

¹ Dieses Produkt ist auf Anfrage mit ZigBee und ZigBee mit PDLs (Präsenz- und Umgebungslichtsensorik) erhältlich. Informationen ab Seite 21.
¹ Upon request this product is available with ZigBee and ZigBee with PDLs (presence detector and ambient light sensor). Information from page 21.

MODUL Q PROJECT

Artikel Article	Maße Dimensions	Technik Technology	Ausführung Version	Art.-Nr. Item no. 2700 K	Art.-Nr. Item no. 3000 K	Art.-Nr. Item no. 4000 K	EUR Netto* EUR Brutto** EUR net* EUR gross**
MODUL Q 220 PROJECT Deckenleuchte für Direktmontage Ceiling luminaire for direct mounting		LED-Technologie LED technology 660 g 3000 K, 6,2 W 4000 K, 6,1 W 24 V DC ~ 750 lm IP 20	ohne Konverter without converter einfach schaltbar switchable dimmbar, CASAMBI dimmable, CASAMBI dimmbar, ZigBee dimmable, ZigBee mit PDLS dimmable, ZigBee with PDLS dimmbar, IQ Sensor dimmable, IQ Sensor		552-492 552-508² 552-502 552-520 554-866	552-496 552-510² 552-504 552-522 554-868	244,00 290,36 398,00 473,62 375,00 446,25 479,00 570,01 433,00 515,27

MODUL Q 220 PROJECT Deckenaufbauleuchte für Direktmontage Surface-mounted ceiling luminaire for direct mounting		LED-Technologie LED technology 720 g 3000 K, 7,6 W 4000 K, 7,5 W 230 V AC ~ 750 lm IP 20	mit Konverter with converter einfach schaltbar switchable dimmbar, CASAMBI dimmable, CASAMBI dimmbar, ZigBee dimmable, ZigBee mit PDLS dimmable, ZigBee with PDLS dimmbar, IQ Sensor dimmable, IQ Sensor		553-034 553-040 553-037 553-046 554-970	553-036 553-042 553-039 553-048 554-972	329,00 391,51 530,00 630,70 459,00 546,21 565,00 672,35 517,00 615,23
--	---	---	--	--	--	--	---

MODUL Q 280 PROJECT Deckenleuchte für Direktmontage Ceiling luminaire for direct mounting		LED-Technologie LED technology 950 g 3000 K, 8,9 W 4000 K, 8,8 W 24 V DC ~ 1200 lm IP 20	ohne Konverter without converter einfach schaltbar switchable dimmbar, CASAMBI dimmable, CASAMBI dimmbar, ZigBee dimmable, ZigBee mit PDLS dimmable, ZigBee with PDLS dimmbar, IQ Sensor dimmable, IQ Sensor		549-863 550-443² 550-440 551-999 554-809	549-864 550-447² 550-442 552-001 554-811	306,00 364,14 460,00 547,40 437,00 520,03 542,00 644,98 495,00 589,05
--	--	---	--	--	--	--	---

MODUL Q 280 PROJECT Deckenaufbauleuchte für Direktmontage Surface-mounted ceiling luminaire for direct mounting		LED-Technologie LED technology 1140 g 3000 K, 10,9 W 4000 K, 10,8 W 230 V AC ~ 1200 lm IP 20	mit Konverter with converter einfach schaltbar switchable dimmbar, DALI/switchDim dimmable, DALI/switchDim dimmbar, CASAMBI dimmable, CASAMBI dimmbar, ZigBee dimmable, ZigBee dimmbar, ZigBee mit PDLS dimmable, ZigBee with PDLS dimmbar, IQ Sensor dimmable, IQ Sensor		550-183 550-186 550-204 550-201 552-543 554-988	550-185 550-188 550-206 550-203 552-545 554-990	391,00 465,29 539,00 641,41 592,00 704,48 521,00 619,99 626,00 744,94 580,00 690,20
--	---	---	--	--	--	--	--

MODUL Q PROJECT

Artikel Article	Maße Dimensions	Technik Technology	Ausführung Version	Art.-Nr. Item no. 2700 K	Art.-Nr. Item no. 3000 K	Art.-Nr. Item no. 4000 K	EUR Netto* EUR Brutto** EUR net* EUR gross**
MODUL Q 340 PROJECT Deckenleuchte für Direktmontage Ceiling luminaire for direct mounting		LED-Technologie LED technology 1300 g 3000 K, 13,8 W 4000 K, 13,6 W 24 V DC ~ 1800 lm IP 20	ohne Konverter without converter einfach schaltbar switchable dimmbar, CASAMBI dimmable, CASAMBI dimmbar, ZigBee dimmable, ZigBee mit PDLS dimmable, ZigBee with PDLS dimmbar, IQ Sensor dimmable, IQ Sensor		549-866 550-474² 550-471 552-599 554-840	549-867 550-476² 550-473 552-600 554-842	466,00 554,54 619,00 736,61 595,00 708,05 701,00 834,19 653,00 777,07

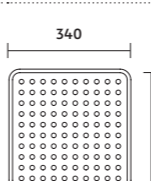
MODUL Q 340 PROJECT Deckenaufbauleuchte für Direktmontage Surface-mounted ceiling luminaire for direct mounting		LED-Technologie LED technology 1600 g 3000 K, 16,5 W 4000 K, 16,4 W 230 V AC ~ 1800 lm IP 20	mit Konverter with converter einfach schaltbar switchable dimmbar, DALI/switchDim dimmable, DALI/switchDim dimmbar, CASAMBI dimmable, CASAMBI dimmbar, ZigBee dimmable, ZigBee dimmbar, IQ Sensor dimmable, IQ Sensor		550-198 550-195 550-210 550-207 554-994	550-200 550-197 550-212 550-209 554-996	550,00 654,50 695,00 827,05 752,00 894,88 680,00 809,20 739,00 879,41
--	---	---	--	--	--	--	---

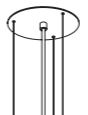
Modul Q/R Project Pendelset für 220/280/340		230 V	Länge 2 m length 2 m	553-249	553-249	553-249	156,00 185,64
Modul Q/R Project Suspension kit for 220/280/340			Länge 4 m length 4 m	553-250	553-250	553-250	180,00 214,20

Modul Q/R Project Pendelset für 220/280/340		24 V	ohne 24 V-Weiterleitung: für Ausführung einfach schaltbar without 24 V forwarding: for the on/off only ver- sion	Länge 2 m length 2 m Länge 4 m length 4 m	555-719 555-721	555-719 555-721	555-719 555-721	156,00 185,64 180,00 214,20
Modul Q/R Project Suspension kit for 220/280/340			mit 24 V-Weiterleitung: für Ausführung ZigBee/ CASAMBI /IQ Sensor with 24 V forwarding: for the ZigBee/ CASAMBI /IQ Sensor version	Länge 2 m length 2 m Länge 4 m length 4 m	555-716 555-718	555-716 555-718	555-716 555-718	156,00 185,64 180,00 214,20



* Der in der Preisliste ausgewiesene Nettopreis versteht sich zzgl. der gesetzlichen Mehrwertsteuer.
* The net price shown in the price list is without statutory value-added tax.

** Der in der Preisliste ausgewiesene Bruttobetrag versteht sich inkl. der gesetzlichen Mehrwertsteuer.
** The gross price shown in the price list is with statutory value-added tax.

¹ Dieses Produkt ist auf Anfrage mit ZigBee und ZigBee mit PDLS (Präsenz- und Umgebungslichtsensorik) erhältlich. Informationen ab Seite 21.
¹ Upon request this product is available with ZigBee and ZigBee with PDLS (presence detector and ambient light sensor), information from page 21.

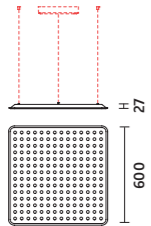
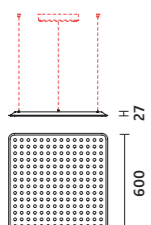

² Nicht über Schalter dimmbar, nur über App oder **CASAMBI** Wandschalter steuerbar.
² Cannot be dimmed via switch. Can only be controlled via app or **CASAMBI** wall switch.

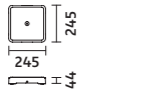
MODUL Q PROJECT

Artikel Article	Maße Dimensions	Technik Technology	Ausführung Version	Art.-Nr. Item no. 2700 K	Art.-Nr. Item no. 3000 K	Art.-Nr. Item no. 4000 K	EUR Netto* EUR net*	EUR Brutto** EUR gross**
MODUL Q 600 PROJECT Pendelleuchte Suspended luminaire		LED-Technologie LED technology 7460 g 32 W, 24 V DC ~ 3655 lm IP 20	ohne Konverter without converter ohne Aufbaugehäuse without ceiling-mounted housing ohne Pendelset without suspension kit		546-829	546-830	1.130,00	1.344,70
MODUL Q 600 PROJECT Pendelleuchte mit Indirektanteil Suspended luminaire with additional indirect light		LED-Technologie LED technology 7460 g 39 W, 24 V DC ~ 4300 lm IP 20	ohne Konverter without converter ohne Aufbaugehäuse without ceiling-mounted housing ohne Pendelset without suspension kit		546-579	546-832	1.272,00	1.513,68
Pendelset Modul Q Project Suspension kit Modul Q Project			Länge 2 m length 2 m Länge 4 m length 4 m		546-767	546-767	106,00	126,14
			Länge 4 m length 4 m		546-768	546-768	117,00	139,23
Konverter in separatem Aufbaugehäuse Converter in separate ceiling-mounted housing			weiß white					
			einfach schaltbar switchable dimmbar, 1–10 V dimmbare, 1–10 V dimmbar, DALI/switchDim dimmbare, DALI/switchDim dimmbare, CASAMBI dimmbare, CASAMBI		546-844¹	546-844¹	172,00	204,68
					546-843	546-843	236,00	280,84
					546-735	546-735	312,00	371,28
					549-720	549-720	374,00	445,06

Auf Anfrage mit
Upon request with 

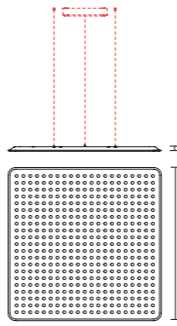
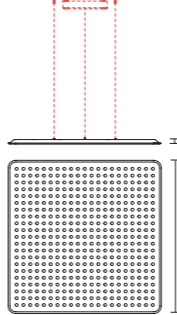
MODUL Q PROJECT

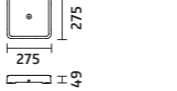
Artikel Article	Maße Dimensions	Technik Technology	Ausführung Version	Art.-Nr. Item no. 2700 K	Art.-Nr. Item no. 3000 K	Art.-Nr. Item no. 4000 K	EUR Netto* EUR net*	EUR Brutto** EUR gross**
MODUL Q 900 PROJECT Pendelleuchte Suspended luminaire		LED-Technologie LED technology ca. 16 kg 59 W, 24 V DC ~ 6475 lm IP 20	ohne Konverter without converter ohne Aufbaugehäuse without ceiling-mounted housing ohne Pendelset without suspension kit		546-834	546-835	1.960,00	2.332,40
MODUL Q 900 PROJECT Pendelleuchte mit Indirektanteil Suspended luminaire with additional indirect light		LED-Technologie LED technology ca. 16,7 kg 66 W, 24 V DC ~ 7120 lm IP 20	ohne Konverter without converter ohne Aufbaugehäuse without ceiling-mounted housing ohne Pendelset without suspension kit		546-613	546-837	2.100,00	2.499,00
Pendelset Modul Q Project Suspension kit Modul Q Project			Länge 2 m length 2 m Länge 4 m length 4 m		546-767	546-767	106,00	126,14
			Länge 4 m length 4 m		546-768	546-768	117,00	139,23
Konverter in separatem Aufbaugehäuse Converter in separate ceiling-mounted housing			weiß white					
			einfach schaltbar switchable dimmbar, 1–10 V dimmbare, 1–10 V dimmbar, DALI/switchDim dimmbare, DALI/switchDim dimmbare, CASAMBI dimmbare, CASAMBI		546-846¹	546-846¹	172,00	204,68
					546-845	546-845	236,00	280,84
					546-736	546-736	312,00	371,28
					550-857	550-857	374,00	445,06

Auf Anfrage mit
Upon request with 



* Der in der Preisliste ausgewiesene Nettopreis versteht sich zzgl. der gesetzlichen Mehrwertsteuer.
* The net price shown in the price list is without statutory value-added tax.

** Der in der Preisliste ausgewiesene Bruttobetrag versteht sich inkl. der gesetzlichen Mehrwertsteuer.
** The gross price shown in the price list is with statutory value-added tax.

 Nicht enthaltene Zubehör ist farbig gekennzeichnet.
Accessories not included in delivery are marked in colour.

¹ Dieses Produkt ist auf Anfrage mit ZigBee und ZigBee mit PDLs (Präsenz- und Umgebungslichtsensorik) erhältlich. Informationen ab Seite 21.
¹ Upon request this product is available with ZigBee and ZigBee with PDLs (presence detector and ambient light sensor). Information from page 21.

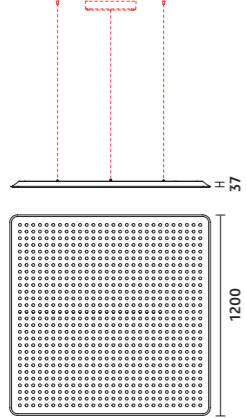
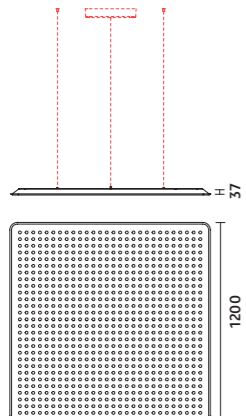
MODUL Q PROJECT

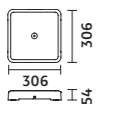
Artikel Article	Maße Dimensions	Technik Technology	Ausführung Version	Art.-Nr. Item no. 2700 K	Art.-Nr. Item no. 3000 K	Art.-Nr. Item no. 4000 K	EUR Netto* EUR Brutto** EUR net* EUR gross**
MODUL Q 1200 PROJECT Pendelleuchte Suspended luminaire		LED-Technologie LED technology ca. 30,4 kg 108 W, 24 V DC ~ 11839 lm IP 20	ohne Konverter without converter ohne Aufbaueinheit without ceiling-mounted housing ohne Pendelset without suspension kit	546-839	546-840		3.567,00 4.244,73
MODUL Q 1200 PROJECT Pendelleuchte mit Indirektanteil Suspended luminaire with additional indirect light		LED-Technologie LED technology ca. 31,1 kg 115 W, 24 V DC ~ 12484 lm IP 20	ohne Konverter without converter ohne Aufbaueinheit without ceiling-mounted housing ohne Pendelset without suspension kit	546-614	546-842		3.706,00 4.410,14
Pendelset Modul Q Project Suspension kit Modul Q Project			Länge 2 m length 2 m Länge 4 m length 4 m	546-767	546-767		106,00 126,14
Konverter in separatem Aufbaueinheit Converter in separate ceiling-mounted housing			weiß white	546-848¹	546-848¹		342,00 406,98
			einfach schaltbar switchable	546-847	546-847		511,00 608,09
			dimmbar, 1–10 V dimmbable, 1–10 V	546-740	546-740		562,00 668,78
			dimmbar, DALI/switchDim dimmbable, DALI/switchDim	551-398	551-398		544,00 647,36
			dimmbar, CASAMBI dimmbable, CASAMBI				

Auf Anfrage mit
Upon request with 

CUBIC

Artikel Article	Maße Dimensions	Technik Technology	Ausführung Version	Art.-Nr. Item no. 2700 K	Art.-Nr. Item no. 3000 K	Art.-Nr. Item no. 4000 K	EUR Netto* EUR Brutto** EUR net* EUR gross**
CUBIC 9 Leuchtenkopf luminaire head		LED-Technologie LED technology 145 g 2700 K, 2,9 W 3000 K, 2,7 W 4000 K, 2,6 W 24 V DC 160 lm IP 20 CRI > 90	ohne Konverter, ohne Montagezubehör without mounting accessories	555-795	555-796	555-797	113,00 134,47
CUBIC 9 AQUA Leuchtenkopf luminaire head		LED-Technologie LED technology 145 g 2700 K, 2,9 W 3000 K, 2,7 W 4000 K, 2,6 W 24 V DC 160 lm IP 44 CRI > 90	ohne Konverter, ohne Montagezubehör without mounting accessories	558-502	558-359	558-503	143,00 170,17
CUBIC 36 Leuchtenkopf luminaire head		LED-Technologie LED technology 260 g 2700 K, 7,1 W 3000 K, 6,8 W 4000 K, 6,5 W 24 V DC 630 lm IP 20 CRI > 90	ohne Konverter, ohne Montagezubehör without mounting accessories	555-517	555-518	555-519	200,00 238,00
CUBIC 36 FRAME Deckenleuchte mit Aufbaueinheit aus Aluminium Ceiling luminaire with surface-mounted frame made of aluminium		LED-Technologie LED technology 950 g 2700 K, 9,9 W 3000 K, 9,6 W 4000 K, 9,2 W 230 V AC ~ 630 lm IP 20 CRI > 90	integrierter Konverter, dimmbar über Phasen-/abschnitt, integrated converter, dimmbable via trailing / leading edge dimmer				
			schwarz matt matt black weiß matt matt white	557-800	557-801	557-802	361,00 429,59
				557-803	557-804	557-805	361,00 429,59
CUBIC 36 AQUA Leuchtenkopf luminaire head		LED-Technologie LED technology 260 g 2700 K, 7,1 W 3000 K, 6,8 W 4000 K, 6,5 W 24 V DC 630 lm IP 44 CRI > 90	ohne Konverter, ohne Montagezubehör without mounting accessories	558-504	558-360	558-505	281,00 334,39

 Nicht enthaltenes Zubehör ist farbig gekennzeichnet.
Accessories not included in delivery are marked in colour.

¹ Dieses Produkt ist auf Anfrage mit ZigBee erhältlich. Informationen ab Seite 21.
¹ Upon request this product is available with ZigBee. Information from page 21.



* Der in der Preisliste ausgewiesene Nettopreis versteht sich zzgl. der gesetzlichen Mehrwertsteuer.
* The net price shown in the price list is without statutory value-added tax.

** Der in der Preisliste ausgewiesene Bruttobetrag versteht sich inkl. der gesetzlichen Mehrwertsteuer.
** The gross price shown in the price list is with statutory value-added tax.

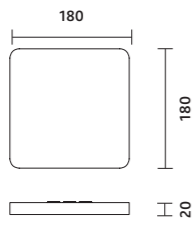
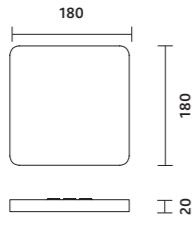
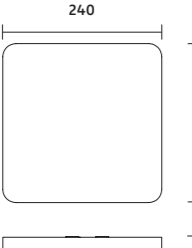
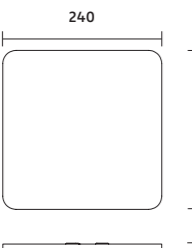
CUBIC

Artikel Article	Maße Dimensions	Technik Technology	Ausführung Version	Art.-Nr. Item no. 2700 K	Art.-Nr. Item no. 3000 K	Art.-Nr. Item no. 4000 K	EUR Netto* EUR net*	EUR Brutto** EUR gross**
CUBIC 49 Leuchtenkopf luminaire head		LED-Technologie LED technology 570 g 2700 K, 10,3 W 3000 K, 9,8 W 4000 K, 9,3 W 24 V DC 880 lm IP 20 CRI > 90	ohne Konverter, ohne Montagezubehör without mounting accessories	555-780	555-781	555-782	271,00	322,49
CUBIC 49 AQUA Leuchtenkopf luminaire head		LED-Technologie LED technology 570 g 2700 K, 10,3 W 3000 K, 9,8 W 4000 K, 9,3 W 24 V DC 880 lm IP 44 CRI > 90	ohne Konverter, ohne Montagezubehör without mounting accessories	558-506	558-361	558-507	307,00	365,33
CUBIC 64 Leuchtenkopf luminaire head		LED-Technologie LED technology 1000 g 2700 K, 11,5 W 3000 K, 10,9 W 4000 K, 10,5 W 24 V DC 1100 lm IP 20 CRI > 90	ohne Konverter, ohne Montagezubehör without mounting accessories	555-789	555-790	555-791	408,00	485,52
CUBIC 64 AQUA Leuchtenkopf luminaire head		LED-Technologie LED technology 1000 g 2700 K, 11,5 W 3000 K, 10,9 W 4000 K, 10,5 W 24 V DC 1100 lm IP 44 CRI > 90	ohne Konverter, ohne Montagezubehör without mounting accessories	558-508	558-362	558-509	452,00	537,88

CUBIC

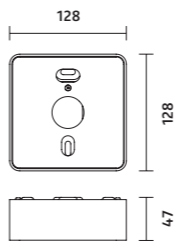
Artikel Article	Maße Dimensions	Technik Technology	Ausführung Version	Art.-Nr. Item no. 2700 K	Art.-Nr. Item no. 3000 K	Art.-Nr. Item no. 4000 K	EUR Netto* EUR net*	EUR Brutto** EUR gross**
Montagezubehör CUBIC 9 Mounting accessories Cubic 9								
Deckenring für Direktmontage ceiling ring for direct mounting			Stahlblech verzinkt galvanised steel	002-877	002-877	002-877	5,95	7,08
Montagezubehör CUBIC 36/49/64 Mounting accessories Cubic 36/49/64								
Deckenring für Direktmontage ceiling ring for direct mounting			Stahlblech verzinkt galvanised steel	002-383	002-383	002-383	13,00	15,47
Deckenring für Hohlraumeinbau bracket for cavity mounting			Stahlblech verzinkt galvanised steel	006-610	006-610	006-610	28,00	33,32
FRAME 36 Aufbaugehäuse aus Aluminium, für CUBIC 36 / Modul Q 36 Leuchtenkopf surface-mounted frame made of aluminium, for Cubic 36 / Modul Q 36 luminaire head		700 g 230 V AC / 50 Hz, sek. 24 V DC / 15 W IP 20	integrierter Konverter, dimmbar über Phasen-/abschnitt, integrated converter, dimmable via trailing / leading edge dimmer					
			schwarz matt matt black weiß matt matt white	557-806	557-806	557-806	162,00	192,78
				557-807	557-807	557-807	162,00	192,78





* Der in der Preisliste ausgewiesene Nettopreis versteht sich zzgl. der gesetzlichen Mehrwertsteuer.
* The net price shown in the price list is without statutory value-added tax.

** Der in der Preisliste ausgewiesene Bruttobetrag versteht sich inkl. der gesetzlichen Mehrwertsteuer.
** The gross price shown in the price list is with statutory value-added tax.

i Nicht enthaltene Zubehör ist farbig gekennzeichnet.
Accessories not included in delivery are marked in colour.

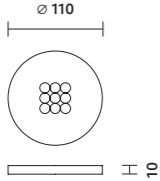
¹ Dieses Produkt ist auf Anfrage mit ZigBee erhältlich. Informationen ab Seite 21.
¹ Upon request this product is available with ZigBee. Information from page 21.

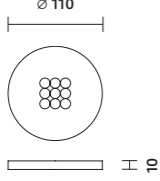

MODUL R

Artikel Article	Maße Dimensions	Technik Technology	Ausführung Version	Art.-Nr. Item no. 2700 K	Art.-Nr. Item no. 3000 K	Art.-Nr. Item no. 4000 K	EUR Netto* EUR net*	EUR Brutto** EUR gross**
MODUL R 9 Deckenleuchte für Direktmontage Ceiling luminaire for direct mounting		LED-Technologie LED technology 172 g 2700 K, 2,9 W 3000 K, 2,7 W 4000 K, 2,6 W 24 V DC ~ 190 lm IP 20 CRI > 90	ohne Konverter without converter	010-387	006-378	010-388	119,00	141,61
Deckenleuchte für Hohlraumbau Ceiling luminaire for cavity mounting		LED-Technologie LED technology 178 g 2700 K, 2,9 W 3000 K, 2,7 W 4000 K, 2,6 W 24 V DC ~ 190 lm IP 20 CRI > 90	ohne Konverter without converter	010-389	006-415	010-391	142,00	168,98
MODUL R 9 AQUA Deckenleuchte für Direktmontage Ceiling luminaire for direct mounting		LED-Technologie LED technology 175 g 2700 K, 2,9 W 3000 K, 2,7 W 24 V DC ~ 190 lm IP 44 CRI > 90	ohne Konverter without converter	010-399	006-442		157,00	186,83
Deckenleuchte für Hohlraumbau Ceiling luminaire for cavity mounting		LED-Technologie LED technology 178 g 2700 K, 2,9 W 3000 K, 2,7 W 24 V DC ~ 190 lm IP 44 CRI > 90	ohne Konverter without converter	010-402	007-407		180,00	214,20

* Der in der Preisliste ausgewiesene Nettopreis versteht sich zzgl. der gesetzlichen Mehrwertsteuer.
* The net price shown in the price list is without statutory value-added tax.

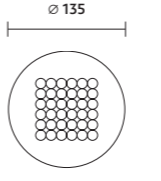
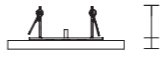
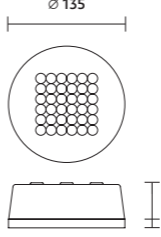

** Der in der Preisliste ausgewiesene Bruttobetrag versteht sich inkl. der gesetzlichen Mehrwertsteuer.
** The gross price shown in the price list is with statutory value-added tax.

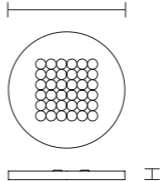
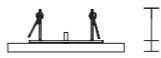
MODUL R

Artikel Article	Maße Dimensions	Technik Technology	Ausführung Version	Art.-Nr. Item no. 2700 K	Art.-Nr. Item no. 3000 K	Art.-Nr. Item no. 4000 K	EUR Netto* EUR net*	EUR Brutto** EUR gross**
MODUL R 36 Deckenleuchte für Direktmontage Ceiling luminaire for direct mounting		LED-Technologie LED technology 260 g 2700 K, 7,1 W 3000 K, 6,8 W 4000 K, 6,5 W 24 V DC ~ 750 lm IP 20 CRI > 90	ohne Konverter without converter	010-233	006-361	010-236	213,00	253,47
Deckenleuchte für Hohlraumbau Ceiling luminaire for cavity mounting		LED-Technologie LED technology 270 g 2700 K, 7,1 W 3000 K, 6,8 W 4000 K, 6,5 W 24 V DC ~ 750 lm IP 20 CRI > 90	ohne Konverter without converter	010-239	006-418	010-241	226,00	268,94
MODUL R 36 Deckenleuchte mit Aufbaugeschütz 35 mm Ceiling luminaire with surface-mounted housing 35 mm		LED-Technologie LED technology 437 g 2700 K, 8,7 W 3000 K, 8,3 W 4000 K, 7,9 W 230 V AC ~ 750 lm IP 20 CRI > 90	mit Konverter with converter	010-243¹	006-419¹	010-251¹	361,00	429,99
				Auf Anfrage mit ZigBee Upon request with 				
MODUL R 36 AQUA Deckenleuchte für Direktmontage Ceiling luminaire for direct mounting		LED-Technologie LED technology 266 g 2700 K, 7,1 W 3000 K, 6,8 W 24 V DC ~ 750 lm IP 44 CRI > 90	ohne Konverter without converter	010-259	006-443		292,00	347,48
Deckenleuchte für Hohlraumbau Ceiling luminaire for cavity mounting		LED-Technologie LED technology 277 g 2700 K, 7,1 W 3000 K, 6,8 W 24 V DC ~ 750 lm IP 44 CRI > 90	ohne Konverter without converter	010-289	007-409		305,00	362,95

¹ Dieses Produkt ist auf Anfrage mit ZigBee erhältlich. Informationen ab Seite 21.
¹ Upon request this product is available with ZigBee. Information from page 21.

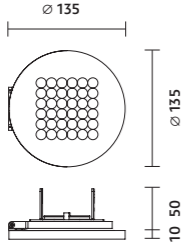
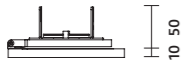
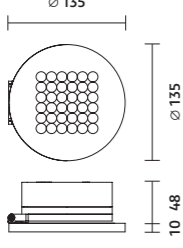



MODUL R

Artikel Article	Maße Dimensions	Technik Technology	Ausführung Version	Art.-Nr. Item no. 2700 K	Art.-Nr. Item no. 3000 K	Art.-Nr. Item no. 4000 K	EUR Netto* EUR net*	EUR Brutto** EUR gross**
MODUL R 36 TT Deckenleuchte für Hohlraumbau Ceiling luminaire for cavity mounting		LED-Technologie LED technology 520 g 2700 K, 7,1 W 3000 K, 6,8 W 4000 K, 6,5 W 24 V DC ~750 lm IP 20 CRI > 90	ohne Konverter without converter weiß lackiert white varnished	010-331	006-991	010-333	329,00	391,51
Deckenleuchte für Beton-Einbaudose HaloX-O mit Frontteil Ceiling luminaire for concrete mounting box HaloX-O with front		LED-Technologie LED technology 520 g 2700 K, 7,1 W 3000 K, 6,8 W 4000 K, 6,5 W 24 V DC ~750 lm IP 20 CRI > 90	ohne Konverter without converter weiß lackiert white varnished	010-271	007-391	010-272	329,00	391,51
MODUL R 36 TT Deckenleuchte mit Aufbaugehäuse 48 mm Ceiling luminaire with surface-mounted housing 48 mm		LED-Technologie LED technology 748 g 2700 K, 8,7 W 3000 K, 8,3 W 4000 K, 7,9 W 230 V AC ~750 lm IP 20 CRI > 90	mit Konverter with converter weiß lackiert white varnished	010-283	007-395	010-284	537,00	639,03
Deckenleuchte mit Aufbaugehäuse 21 mm Ceiling luminaire with surface-mounted housing 21 mm		LED-Technologie LED technology 375 g 2700 K, 7,1 W 3000 K, 6,8 W 4000 K, 6,5 W 24 V DC ~750 lm IP 20 CRI > 90	ohne Konverter without converter weiß lackiert white varnished	010-277	007-393	010-278	426,00	506,94

* Der in der Preisliste ausgewiesene Nettopreis versteht sich zzgl. der gesetzlichen Mehrwertsteuer.
* The net price shown in the price list is without statutory value-added tax.

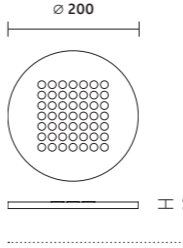
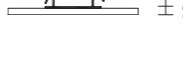
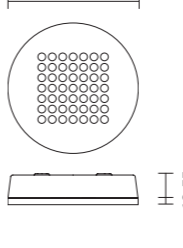
** Der in der Preisliste ausgewiesene Bruttobetrag versteht sich inkl. der gesetzlichen Mehrwertsteuer.
** The gross price shown in the price list is with statutory value-added tax.

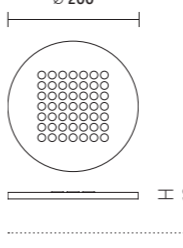
MODUL R

Artikel Article	Maße Dimensions	Technik Technology	Ausführung Version	Art.-Nr. Item no. 2700 K	Art.-Nr. Item no. 3000 K	Art.-Nr. Item no. 4000 K	EUR Netto* EUR net*	EUR Brutto** EUR gross**
MODUL R 49 Deckenleuchte für Direktmontage Ceiling luminaire for direct mounting		LED-Technologie LED technology 452 g 2700 K, 10,3 W 3000 K, 9,8 W 4000 K, 9,3 W 24 V DC ~1050 lm IP 20 CRI > 90	ohne Konverter without converter	010-348	006-362	010-349	313,00	372,47
Deckenleuchte für Hohlraumbau Ceiling luminaire for cavity mounting		LED-Technologie LED technology 468 g 2700 K, 10,3 W 3000 K, 9,8 W 4000 K, 9,3 W 24 V DC ~1050 lm IP 20 CRI > 90	ohne Konverter without converter	010-350	006-421	010-351	324,00	385,56
MODUL R 49 Deckenleuchte mit Aufbaugehäuse 35 mm Ceiling luminaire with surface-mounted housing 35 mm		LED-Technologie LED technology 783 g 2700 K, 12,4 W 3000 K, 11,8 W 4000 K, 11,2 W 230 V AC ~1050 lm IP 20 CRI > 90	mit Konverter with converter	010-355¹	006-422¹	010-357¹	426,00	506,94
				Auf Anfrage mit Upon request with 				
		LED-Technologie LED technology 783 g 2700 K, 12,5 W 3000 K, 11,9 W 4000 K, 11,4 W 230 V AC ~1050 lm IP 20 CRI > 90	dimmbar, CASAMBI dimmable, CASAMBI mit Konverter und Dimmer with converter and dimmer	547-598	547-596	547-597	627,00	746,13
MODUL R 49 AQUA Deckenleuchte für Direktmontage Ceiling luminaire for direct mounting		LED-Technologie LED technology 454 g 2700 K, 10,3 W 3000 K, 9,8 W 24 V DC ~1050 lm IP 44 CRI > 90	ohne Konverter without converter	010-361	006-444		350,00	416,50
Deckenleuchte für Hohlraumbau Ceiling luminaire for cavity mounting		LED-Technologie LED technology 470 g 2700 K, 10,3 W 3000 K, 9,8 W 24 V DC ~1050 lm IP 44 CRI > 90	ohne Konverter without converter	010-365	007-418		362,00	430,78

¹ Dieses Produkt ist auf Anfrage mit ZigBee erhältlich. Informationen ab Seite 21.
¹ Upon request this product is available with ZigBee. Information from page 21.

MODUL R

Artikel Article	Maße Dimensions	Technik Technology	Ausführung Version	Art.-Nr. Item no. 2700 K	Art.-Nr. Item no. 3000 K	Art.-Nr. Item no. 4000 K	EUR Netto* EUR net*	EUR Brutto** EUR gross**
MODUL R 64 Deckenleuchte für Direktmontage Ceiling luminaire for direct mounting		LED-Technologie LED technology 770 g 2700 K, 11,5 W 3000 K, 10,9 W 4000 K, 10,5 W 24 V DC ~ 1350 lm IP 20 CRI > 90	ohne Konverter without converter	010-369	006-363	010-370	446,00	530,74
Deckenleuchte für Hohlraumbau Ceiling luminaire for cavity mounting		LED-Technologie LED technology 870 g 2700 K, 11,5 W 3000 K, 10,9 W 4000 K, 10,5 W 24 V DC ~ 1350 lm IP 20 CRI > 90	ohne Konverter without converter	010-372	006-424	010-373	462,00	549,78
MODUL R 64 Deckenleuchte mit Aufbaugeschäube 35 mm Ceiling luminaire with surface-mounted housing 35 mm		LED-Technologie LED technology 1112 g 2700 K, 13,6 W 3000 K, 12,9 W 4000 K, 12,5 W 230 V AC ~ 1350 lm IP 20 CRI > 90	mit Konverter with converter	010-375¹	006-425¹	010-377¹	595,00	708,05
				Auf Anfrage mit Upon request with				
		LED-Technologie LED technology 1112 g 2700 K, 13,7 W 3000 K, 13 W 4000 K, 12,6 W 230 V AC ~ 1350 lm IP 20 CRI > 90	dimmbar, CASAMBI dimmable, CASAMBI mit Konverter und Dimmer with converter and dimmer	547-742	547-617	547-741	797,00	948,43
MODUL R 64 AQUA Deckenleuchte für Direktmontage Ceiling luminaire for direct mounting		LED-Technologie LED technology 770 g 2700 K, 11,5 W 3000 K, 10,9 W 24 V DC ~ 1350 lm IP 44 CRI > 90	ohne Konverter without converter	010-383	006-445		477,00	567,63
Deckenleuchte für Hohlraumbau Ceiling luminaire for cavity mounting		LED-Technologie LED technology 870 g 2700 K, 11,5 W 3000 K, 10,9 W 24 V DC ~ 1350 lm IP 44 CRI > 90	ohne Konverter without converter	010-385	007-439		492,00	585,48

* Der in der Preisliste ausgewiesene Nettopreis versteht sich zzgl. der gesetzlichen Mehrwertsteuer.
* The net price shown in the price list is without statutory value-added tax.



** Der in der Preisliste ausgewiesene Bruttobetrag versteht sich inkl. der gesetzlichen Mehrwertsteuer.
** The gross price shown in the price list is with statutory value-added tax.

MODUL R

Artikel Article	Maße Dimensions	Technik Technology	Ausführung Version	Art.-Nr. Item no. 2700 K	Art.-Nr. Item no. 3000 K	Art.-Nr. Item no. 4000 K	EUR Netto* EUR net*	EUR Brutto** EUR gross**
MODUL R 100 Deckenleuchte für Direktmontage Ceiling luminaire for direct mounting		LED-Technologie LED technology 1436 g 2700 K, 19 W 3000 K, 18,1 W 4000 K, 17,3 W 24 V DC ~ 2150 lm IP 20 CRI > 90	ohne Konverter without converter	010-152	006-384	010-153	550,00	654,50
Deckenleuchte für Hohlraumbau Ceiling luminaire for cavity mounting		LED-Technologie LED technology 1588 g 2700 K, 19 W 3000 K, 18,1 W 4000 K, 17,3 W 24 V DC ~ 2150 lm IP 20 CRI > 90	ohne Konverter without converter	010-154	006-426	010-161	580,00	690,20
MODUL R 100 Deckenleuchte mit Aufbaugeschäube 35 mm Ceiling luminaire with surface-mounted housing 35 mm		LED-Technologie LED technology 1706 g 2700 K, 22,5 W 3000 K, 21,5 W 4000 K, 20,5 W 230 V AC ~ 2150 lm IP 20 CRI > 90	mit Konverter with converter	010-162¹	006-428¹	010-163¹	649,00	772,31
				Auf Anfrage mit Upon request with				
		LED-Technologie LED technology 1706 g 2700 K, 22,6 W 3000 K, 21,6 W 4000 K, 20,6 W 230 V AC ~ 2150 lm IP 20 CRI > 90	dimmbar, CASAMBI dimmable, CASAMBI mit Konverter und Dimmer with converter and dimmer	547-751	547-749	547-750	851,00	1.012,69
MODUL R 100 AQUA Deckenleuchte für Direktmontage Ceiling luminaire for direct mounting		LED-Technologie LED technology 1436 g 2700 K, 19 W 3000 K, 18,1 W 24 V DC ~ 2150 lm IP 44 CRI > 90	ohne Konverter without converter	544-953	544-952		590,00	702,10
Deckenleuchte für Hohlraumbau Ceiling luminaire for cavity mounting		LED-Technologie LED technology 1588 g 2700 K, 19 W 3000 K, 18,1 W 24 V DC ~ 2150 lm IP 44 CRI > 90	ohne Konverter without converter	544-957	544-955		610,00	725,90

¹ Dieses Produkt ist auf Anfrage mit ZigBee erhältlich. Informationen ab Seite 21.
¹ Upon request this product is available with ZigBee. Information from page 21.

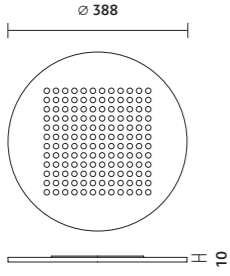
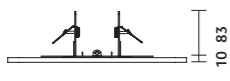
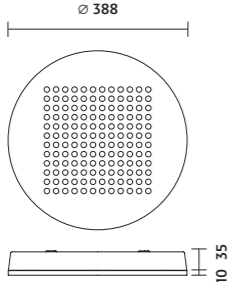
MODUL R

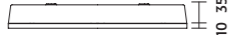
Artikel Article	Maße Dimensions	Technik Technology	Ausführung Version	Art.-Nr. Item no. 2700 K	Art.-Nr. Item no. 3000 K	Art.-Nr. Item no. 4000 K	EUR Netto* EUR Brutto** EUR net* EUR gross**
MODUL R 144 Deckenleuchte für Direktmontage Ceiling luminaire for direct mounting		LED-Technologie LED technology 1943 g 3000 K, 24,4 W 4000 K, 23,3 W 24 V DC ~ 3000 lm IP 20 CRI > 90	ohne Konverter without converter	005-906	010-193		765,00 910,35
Deckenleuchte für Hohlraumbau Ceiling luminaire for cavity mounting		LED-Technologie LED technology 2098 g 3000 K, 24,4 W 4000 K, 23,3 W 24 V DC ~ 3000 lm IP 20 CRI > 90	ohne Konverter without converter	006-430	010-195		794,00 944,86
MODUL R 144 Deckenleuchte mit Aufbaugehäuse 35 mm Ceiling luminaire with surface-mounted housing 35 mm		LED-Technologie LED technology 2522 g 3000 K, 28,3 W 4000 K, 27,1 W 230 V AC ~ 3000 lm IP 20 CRI > 90	mit Konverter with converter	006-431¹	010-198¹		1.003,00 1.193,57
				Auf Anfrage mit Upon request with 			
		LED-Technologie LED technology 2522 g 3000 K, 28,4 W 230 V AC ~ 3000 lm IP 20 CRI > 90	dimmbar, CASAMBI dimmable, CASAMBI mit Konverter und Dimmer with converter and dimmer	547-765			1.204,00 1.432,76

MODUL R PROJECT

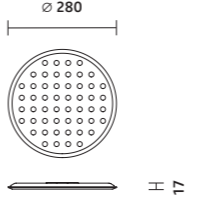
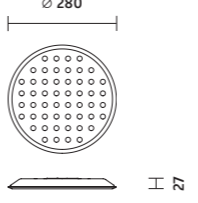
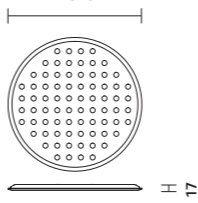
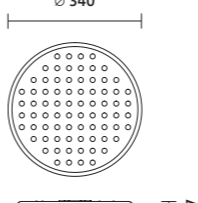
Artikel Article	Maße Dimensions	Technik Technology	Ausführung Version	Art.-Nr. Item no. 2700 K	Art.-Nr. Item no. 3000 K	Art.-Nr. Item no. 4000 K	EUR Netto* EUR Brutto** EUR net* EUR gross**
MODUL R 220 PROJECT Deckenleuchte für Direktmontage Ceiling luminaire for direct mounting		LED-Technologie LED technology 830 g 3000 K, 5,9 W 4000 K, 5,8 W 24 V DC ~ 750 lm IP 20	ohne Konverter without converter				
			einfach schaltbar switchable dimmbar, CASAMBI dimmable, CASAMBI dimmbar, ZigBee dimmable, ZigBee dimmbar, ZigBee mit PDLS dimmable, ZigBee with PDLS dimmbar, IQ Sensor dimmable, IQ Sensor	553-780	553-782		305,00 362,95 459,00 546,21 436,00 518,84 541,00 643,79 494,00 587,86
MODUL R 220 PROJECT Deckenaufbauleuchte für Direktmontage Surface-mounted ceiling luminaire for direct mounting		LED-Technologie LED technology 910 g 3000 K, 7,3 W 4000 K, 7,3 W 230 V AC ~ 750 lm IP 20	mit Konverter with converter				
			einfach schaltbar switchable dimmbar, CASAMBI dimmable, CASAMBI dimmbar, ZigBee dimmable, ZigBee dimmbar, ZigBee mit PDLS dimmable, ZigBee with PDLS dimmbar, IQ Sensor dimmable, IQ Sensor	553-812	553-814		390,00 464,10 591,00 703,29 520,00 618,80 625,00 743,75 579,00 689,01
MODUL R 280 PROJECT Deckenleuchte für Direktmontage Ceiling luminaire for direct mounting		LED-Technologie LED technology 1150 g 3000 K, 9,2 W 4000 K, 9,1 W 24 V DC ~ 1200 lm IP 20	ohne Konverter without converter				
			einfach schaltbar switchable dimmbar, ZigBee dimmable, ZigBee dimmbar, ZigBee mit PDLS dimmable, ZigBee with PDLS dimmbar, IQ Sensor dimmable, IQ Sensor	550-354	552-837		367,00 436,73 497,00 591,43 602,00 716,38 554,00 659,26
MODUL R 280 PROJECT Deckenaufbauleuchte für Direktmontage Surface-mounted ceiling luminaire for direct mounting		LED-Technologie LED technology 1210 g 3000 K, 11 W 4000 K, 10,1 W 230 V AC ~ 1200 lm IP 20	mit Konverter with converter				
			einfach schaltbar switchable dimmbar, DALI/switchDim dimmable, DALI/switchDim dimmbar, CASAMBI dimmable, CASAMBI dimmbar, ZigBee dimmable, ZigBee dimmbar, ZigBee mit PDLS dimmable, ZigBee with PDLS dimmbar, IQ Sensor dimmable, IQ Sensor	550-927	552-958		451,00 536,69 598,00 711,62 652,00 775,88 581,00 691,39 687,00 817,53 640,00 761,60

* Der in der Preisliste ausgewiesene Nettopreis versteht sich zzgl. der gesetzlichen Mehrwertsteuer.
* The net price shown in the price list is without statutory value-added tax.

** Der in der Preisliste ausgewiesene Bruttobetrag versteht sich inkl. der gesetzlichen Mehrwertsteuer.
** The gross price shown in the price list is with statutory value-added tax.

¹ Dieses Produkt ist auf Anfrage mit ZigBee erhältlich. Informationen ab Seite 21.
¹ Upon request this product is available with ZigBee. Information from page 21.



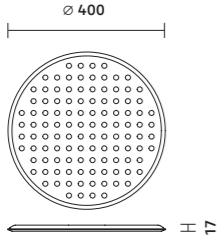
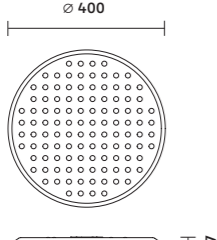
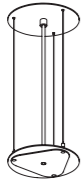
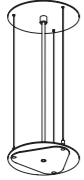

MODUL R PROJECT

Artikel Article	Maße Dimensions	Technik Technology	Ausführung Version	Art.-Nr. Item no. 2700 K	Art.-Nr. Item no. 3000 K	Art.-Nr. Item no. 4000 K	EUR Netto* EUR net*	EUR Brutto** EUR gross**
MODUL R 340 PROJECT Deckenleuchte für Direktmontage Ceiling luminaire for direct mounting		LED-Technologie LED technology 1600 g 3000 K, 13,1 W 4000 K, 12,9 W 24 V DC ~ 1800 lm IP 20	ohne Konverter without converter einfach schaltbar switchable dimmbar, CASAMBI dimmable, CASAMBI dimmbar, ZigBee dimmable, ZigBee dimmbar, ZigBee mit PDLS dimmable, ZigBee with PDLS dimmbar, IQ Sensor dimmable, IQ Sensor		550-356 552-918² 551-219 552-924 554-858	551-218 552-920² 552-917 552-926 554-859	502,00 656,00 632,00 738,00 690,00	597,38 780,64 752,08 878,22 821,10
MODUL R 340 PROJECT Deckenaufbauleuchte für Direktmontage Surface-mounted ceiling luminaire for direct mounting		LED-Technologie LED technology 1690 g 3000 K, 15,1 W 4000 K, 14,8 W 230 V AC ~ 1800 lm IP 20	mit Konverter with converter einfach schaltbar switchable dimmbar, DALI/switchDim dimmable, DALI/switchDim dimmbar, CASAMBI dimmable, CASAMBI dimmbar, ZigBee dimmable, ZigBee dimmbar, ZigBee mit PDLS dimmable, ZigBee with PDLS dimmbar, IQ Sensor dimmable, IQ Sensor		550-928 552-990 552-996 552-993 552-999 554-976	552-956 552-992 552-998 552-995 553-001 554-978	587,00 732,00 789,00 718,00 823,00 776,00	698,53 871,08 938,91 854,42 979,37 923,44
Modul Q/R Project Pendelset für 220/280/340 Modul Q/R Project Suspension kit for 220/280/340		230 V	Länge 2 m length 2 m Länge 4 m length 4 m	553-249 553-250	553-249 553-250		156,00 180,00	185,64 214,20
Modul Q/R Project Pendelset für 220/280/340 Modul Q/R Project Suspension kit for 220/280/340		24 V ohne 24 V-Weiterleitung: für Ausführung einfach schaltbar without 24 V forwarding: for the on/off only version mit 24 V-Weiterleitung: für Ausführung ZigBee/ CASAMBI / IQ-Sensor with 24 V forwarding: for the ZigBee/ CASAMBI / IQ Sensor version	Länge 2 m length 2 m Länge 4 m length 4 m	555-719 555-721 555-716 555-718	555-719 555-721 555-716 555-718		156,00 180,00 156,00 180,00	185,64 214,20 185,64 214,20

* Der in der Preisliste ausgewiesene Nettobetrag versteht sich zzgl. der gesetzlichen Mehrwertsteuer.
* The net price shown in the price list is without statutory value-added tax.

** Der in der Preisliste ausgewiesene Bruttobetrag versteht sich inkl. der gesetzlichen Mehrwertsteuer.
** The gross price shown in the price list is with statutory value-added tax.

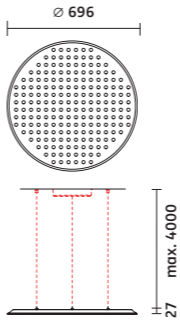
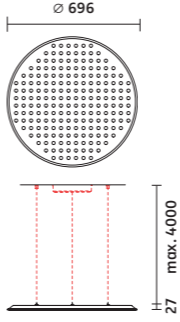
MODUL R PROJECT

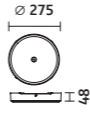
Artikel Article	Maße Dimensions	Technik Technology	Ausführung Version	Art.-Nr. Item no. 2700 K	Art.-Nr. Item no. 3000 K	Art.-Nr. Item no. 4000 K	EUR Netto* EUR net*	EUR Brutto** EUR gross**
MODUL R 600 PROJECT Pendelleuchte Suspended luminaire		LED-Technologie LED technology 7050 g 33 W, 24 V DC ~ 3473 lm IP 20	ohne Konverter without converter ohne Aufbaueinheit without ceiling-mounted housing ohne Pendelset without suspension kit	548-687	550-137		1.189,00	1.414,91
MODUL R 600 PROJECT Pendelleuchte mit Indirektanteil Suspended luminaire with additional indirect light		LED-Technologie LED technology 7600 g 41 W, 24 V DC ~ 4361 lm IP 20	ohne Konverter without converter ohne Aufbaueinheit without ceiling-mounted housing ohne Pendelset without suspension kit	548-686	550-134		1.335,00	1.588,65
Pendelset Modul R Project Suspension kit Modul R Project			Länge 2 m length 2 m Länge 4 m length 4 m	549-489 549-490	549-489 549-490		83,00 91,00	98,77 108,29
Konverter in separatem Aufbaueinheit Converter in separate ceiling-mounted housing			weiß white einfach schaltbar switchable dimmbar, 1-10 V dimmable, 1-10 V dimmbar, DALI/switchDim dimmable, DALI/switchDim dimmbar, CASAMBI dimmable, CASAMBI	549-897¹ 549-893 549-491	549-897¹ 549-893 549-491		172,00 236,00 312,00	204,68 280,84 371,28
				550-868	550-868		374,00	445,06



Auf Anfrage mit
Upon request with 

i Nicht enthaltenes Zubehör ist farbig gekennzeichnet.
Accessories not included in delivery are marked in colour.

¹ Dieses Produkt ist auf Anfrage mit ZigBee erhältlich. Informationen ab Seite 21.
¹ Upon request this product is available with ZigBee. Information from page 21.

² Nicht über Schalter dimmbar, nur über App oder **CASAMBI** Wandschalter steuerbar.
² Cannot be dimmed via switch. Can only be controlled via app or **CASAMBI** wall switch.

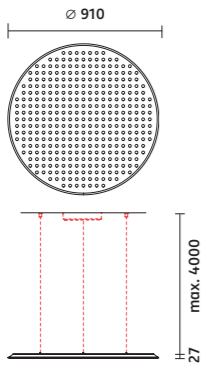
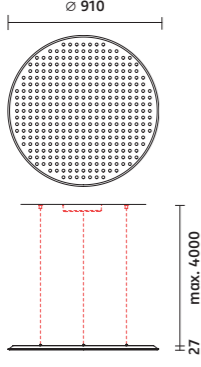
MODUL R PROJECT

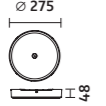
Artikel Article	Maße Dimensions	Technik Technology	Ausführung Version	Art.-Nr. Item no. 2700 K	Art.-Nr. Item no. 3000 K	Art.-Nr. Item no. 4000 K	EUR Netto* EUR net*	EUR Brutto** EUR gross**
MODUL R 900 PROJECT Pendelleuchte Suspended luminaire		LED-Technologie LED technology 13,5 kg 60 W, 24 V DC ~ 6596 lm IP 20	ohne Konverter without converter ohne Aufbauehäuse without ceiling-mounted housing ohne Pendelset without suspension kit		548-689	550-142	2.059,00	2.450,21
MODUL R 900 PROJECT Pendelleuchte mit Indirektanteil Suspended luminaire with additional indirect light		LED-Technologie LED technology 14,1 kg 68 W, 24 V DC ~ 7484 lm IP 20	ohne Konverter without converter ohne Aufbauehäuse without ceiling-mounted housing ohne Pendelset without suspension kit		548-688	550-139	2.205,00	2.623,95
Pendelset Modul R Project Suspension kit Modul R Project			Länge 2 m length 2 m Länge 4 m length 4 m		549-489	549-489	83,00	98,77
					549-490	549-490	91,00	108,29
Konverter in separatem Aufbauehäuse Converter in separate ceiling-mounted housing			weiß white einfach schaltbar switchable dimmbar, 1–10 V dimmbare, 1–10 V dimmbar, DALI/switchDim dimmbare, DALI/switchDim dimmbar, CASAMBI dimmbare, CASAMBI		549-898¹	549-898¹	172,00	204,68
					549-895	549-895	236,00	280,84
					549-492	549-492	312,00	371,28
					551-420	551-420	374,00	445,06

Auf Anfrage mit
Upon request with 

MODUL R PROJECT

Artikel Article	Maße Dimensions	Technik Technology	Ausführung Version	Art.-Nr. Item no. 2700 K	Art.-Nr. Item no. 3000 K	Art.-Nr. Item no. 4000 K	EUR Netto* EUR net*	EUR Brutto** EUR gross**
MODUL R 1200 PROJECT Pendelleuchte Suspended luminaire		LED-Technologie LED technology 25,7 kg 99 W, 24 V DC ~ 11044 lm IP 20	ohne Konverter without converter ohne Aufbauehäuse without ceiling-mounted housing ohne Pendelset without suspension kit		548-691	550-146	3.747,00	4.458,93
MODUL R 1200 PROJECT Pendelleuchte mit Indirektanteil Suspended luminaire with additional indirect light		LED-Technologie LED technology 26,3 kg 107 W, 24 V DC ~ 11932 lm IP 20	ohne Konverter without converter ohne Aufbauehäuse without ceiling-mounted housing ohne Pendelset without suspension kit		548-690	550-144	3.891,00	4.630,29
Pendelset Modul R Project Suspension kit Modul R Project			Länge 2 m length 2 m Länge 4 m length 4 m		549-489	549-489	83,00	98,77
					549-490	549-490	91,00	108,29
Konverter in separatem Aufbauehäuse Converter in separate ceiling-mounted housing			weiß white einfach schaltbar switchable dimmbar, 1–10 V dimmbare, 1–10 V dimmbar, DALI/switchDim dimmbare, DALI/switchDim dimmbar, CASAMBI dimmbare, CASAMBI		549-899¹	549-899¹	342,00	406,98
					549-896	549-896	511,00	608,09
					549-493	549-493	562,00	668,78
					551-089	551-089	544,00	647,36

Auf Anfrage mit
Upon request with 

* Der in der Preisliste ausgewiesene Nettopreis versteht sich zzgl. der gesetzlichen Mehrwertsteuer.
* The net price shown in the price list is without statutory value-added tax.

** Der in der Preisliste ausgewiesene Brutttopreis versteht sich inkl. der gesetzlichen Mehrwertsteuer.
** The gross price shown in the price list is with statutory value-added tax.

 Nicht enthaltene Zubehör ist farbig gekennzeichnet.
Accessories not included in delivery are marked in colour.

¹ Dieses Produkt ist auf Anfrage mit ZigBee erhältlich. Informationen ab Seite 21.
¹ Upon request this product is available with ZigBee. Information from page 21.

MODUL L

Artikel Article	Maße Dimensions	Technik Technology	Ausführung Version	Art.-Nr. Item no. 2700 K	Art.-Nr. Item no. 3000 K	Art.-Nr. Item no. 4000 K	EUR Netto* EUR net*	EUR Brutto** EUR gross**	
MODUL L 112 Pendelleuchte Suspended luminaire		LED-Technologie LED technology ca. 2300 g 14 W, 24 V DC ~ 1860 lm IP 20	ohne Konverter without converter ohne Aufbaugehäuse without ceiling-mounted housing Aluminium eloxiert anodised aluminium	544-752	544-819	544-820	666,00	792,54	
MODUL L 112 Pendelleuchte mit Indirektanteil Suspended luminaire with additional indirect light		LED-Technologie LED technology ca. 2300 g 16 W, 24 V DC ~ 2110 lm IP 20	ohne Konverter without converter ohne Aufbaugehäuse without ceiling-mounted housing Aluminium eloxiert anodised aluminium	544-826	544-827	544-828	752,00	894,88	
Konverter in separatem Aufbaugehäuse Converter in separate ceiling-mounted housing			einfach schaltbar switchable dimmbar, 1–10 V dimmable, 1–10 V dimmbar, DALI/switchDim dimmable, DALI/switchDim dimmbar, CASAMBI dimmable, CASAMBI	544-822¹	544-822¹	544-822¹	71,00	84,49	
				544-824	544-824	544-824	136,00	161,84	
				544-825	544-825	544-825	209,00	248,71	
				547-700	547-700	547-700	273,00	324,87	
				Auf Anfrage mit Upon request with					
Abdeckplatte für Deckenöffnung Cover for ceiling opening			weiß white	005-797	005-797	005-797	38,00	45,22	
MODUL L 112 Deckenaufbauleuchte mit Montageplatte Surface-mounted ceiling luminaire with mounting panel		LED-Technologie LED technology ca. 2300 g 14 W, 24 V DC ~ 1860 lm IP 20	ohne Konverter without converter Aluminium eloxiert anodised aluminium	547-066	547-062	547-064	666,00	792,54	
MODUL L 112 Deckenaufbauleuchte zur Montage an Aufbaugehäuse Surface-mounted ceiling luminaire for mounting on a ceiling-mounted housing		LED-Technologie LED technology ca. 2300 g 14 W, 24 V DC ~ 1860 lm IP 20	ohne Konverter without converter ohne Aufbaugehäuse without ceiling-mounted housing Aluminium eloxiert anodised aluminium	546-908	546-651	546-906	666,00	792,54	
Konverter in separatem Aufbaugehäuse Converter in separate ceiling-mounted housing			einfach schaltbar switchable dimmbar, 1–10 V dimmable, 1–10 V dimmbar, DALI/switchDim dimmable, DALI/switchDim	546-881¹	546-881¹	546-881¹	71,00	84,49	
				546-650	546-650	546-650	136,00	161,84	
				546-882	546-882	546-882	209,00	248,71	
				Auf Anfrage mit Upon request with					

* Der in der Preisliste ausgewiesene Nettopreis versteht sich zzgl. der gesetzlichen Mehrwertsteuer.
* The net price shown in the price list is without statutory value-added tax.

** Der in der Preisliste ausgewiesene Bruttobetrag versteht sich inkl. der gesetzlichen Mehrwertsteuer.
** The gross price shown in the price list is with statutory value-added tax.





MODUL L

Artikel Article	Maße Dimensions	Technik Technology	Ausführung Version	Art.-Nr. Item no. 2700 K	Art.-Nr. Item no. 3000 K	Art.-Nr. Item no. 4000 K	EUR Netto* EUR net*	EUR Brutto** EUR gross**
MODUL L 196 POWER Pendelleuchte mit Indirektanteil Suspended luminaire with additional indirect light		LED-Technologie LED Technology 3500 g 92 W, 24 V DC ~ 10050 lm IP 20	ohne Konverter without converter ohne Aufbaugehäuse without ceiling-mounted housing Aluminium eloxiert anodised aluminium	555-660	555-661		1.520,00	1.808,80
Konverter in separatem Aufbaugehäuse Converter in separate ceiling-mounted housing			weiß white einfach schaltbar switchable dimmbar, 1–10 V dimmable, 1–10 V dimmbar, DALI/switchDim dimmable, DALI/switchDim	545-869	545-869		342,00	406,98
				545-870	545-870		416,00	495,04
				545-871	545-871		452,00	537,88
Externer Konverter für Hohlraumbau External converter for cavity mounting		96 W		551-401	551-401		176,00	209,44
Abdeckplatte für Deckenöffnung Cover for ceiling opening			weiß white	005-797	005-797		38,00	45,22

Nicht enthaltenes Zubehör ist farbig gekennzeichnet.
Accessories not included in delivery are marked in colour.

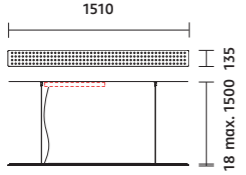
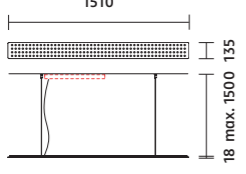
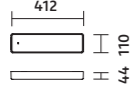

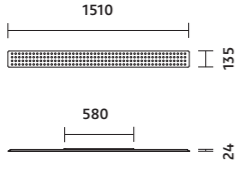
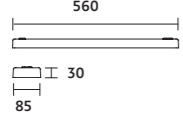



¹ Dieses Produkt ist auf Anfrage mit ZigBee erhältlich. Informationen ab Seite 21.
¹ Upon request this product is available with ZigBee. Information from page 21.

MODUL L

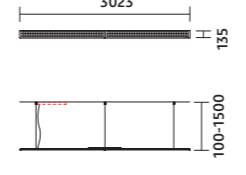
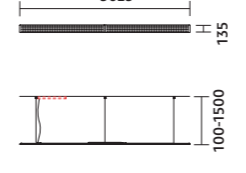
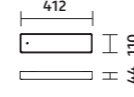
Artikel Article	Maße Dimensions	Technik Technology	Ausführung Version	Art.-Nr. Item no. 2700 K	Art.-Nr. Item no. 3000 K	Art.-Nr. Item no. 4000 K	EUR Netto* EUR net*	EUR Brutto** EUR gross**
MODUL L 196 Pendelleuchte Suspended luminaire		LED-Technologie LED technology 3200 g 23,5 W, 24 V DC ~ 3300 lm IP 20	ohne Konverter without converter ohne Aufbaueinheit without ceiling-mounted housing Aluminium eloxiert anodised aluminium	010-614	009-282	010-095	869,00	1.034,11
MODUL L 196 Pendelleuchte mit Indirektanteil Suspended luminaire with additional indirect light		LED-Technologie LED technology 3300 g 27,5 W, 24 V DC ~ 3800 lm IP 20	ohne Konverter without converter ohne Aufbaueinheit without ceiling-mounted housing Aluminium eloxiert anodised aluminium	010-613	009-281	010-094	1.000,00	1.190,00
Konverter in separatem Aufbaueinheit Converter in separate ceiling-mounted housing			weiß white einfach schaltbar switchable dimmbar, 1–10 V dimmable, 1–10 V dimmbar, DALI/switchDim dimmable, DALI/switchDim dimmbar, CASAMBI dimmable, CASAMBI	009-334¹	009-334¹	009-334¹	71,00	84,49
				009-336	009-336	009-336	136,00	161,84
				009-335	009-335	009-335	209,00	248,71
				547-708	547-708	547-708	273,00	324,87
				Auf Anfrage mit Upon request with 				
Externer Konverter für Hohlraumbau External converter for cavity mounting	l 220 × b 40 × h 21 mm l 220 × w 40 × d 21 mm	35 W		550-843	550-843	550-843	102,00	121,38
Abdeckplatte für Deckenöffnung Cover for ceiling opening	Ø 110 mm 		weiß white	005-797	005-797	005-797	38,00	45,22
MODUL L 196 Deckenaufbauleuchte mit Montageplatte Surface-mounted ceiling luminaire with mounting panel		LED-Technologie LED technology 3200 g 23,5 W, 24 V DC ~ 3300 lm IP 20	ohne Konverter without converter Aluminium eloxiert anodised aluminium	544-836	544-835	544-837	869,00	1.034,11
Externer Konverter für Hohlraumbau External converter for cavity mounting	l 185 × b 64 × h 22 mm l 185 × w 64 × d 22 mm			009-236	009-236	009-236	60,00	71,40
MODUL L 196 Deckenaufbauleuchte zur Montage an Aufbaueinheit Surface-mounted ceiling luminaire for mounting on a ceiling-mounted housing		LED-Technologie LED technology 3200 g 23,5 W, 24 V DC ~ 3300 lm IP 20	ohne Konverter without converter ohne Aufbaueinheit without ceiling-mounted housing Aluminium eloxiert anodised aluminium	544-830	544-829	544-831	869,00	1.034,11
Konverter in separatem Aufbaueinheit Converter in separate ceiling-mounted housing			einfach schaltbar switchable dimmbar, 1–10 V dimmable, 1–10 V dimmbar, DALI/switchDim dimmable, DALI/switchDim dimmbar, CASAMBI dimmable, CASAMBI	544-832¹	544-832¹	544-832¹	71,00	84,49
				544-833	544-833	544-833	136,00	161,84
				544-834	544-834	544-834	209,00	248,71
				547-810	547-810	547-810	273,00	324,87
				Auf Anfrage mit Upon request with 				

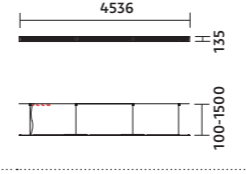
* Der in der Preisliste ausgewiesene Nettopreis versteht sich zzgl. der gesetzlichen Mehrwertsteuer.
* The net price shown in the price list is without statutory value-added tax.
** Der in der Preisliste ausgewiesene Bruttobetrag versteht sich inkl. der gesetzlichen Mehrwertsteuer.
** The gross price shown in the price list is with statutory value-added tax.

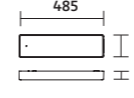
MODUL L

Artikel Article	Maße Dimensions	Technik Technology	Ausführung Version	Art.-Nr. Item no. 2700 K	Art.-Nr. Item no. 3000 K	Art.-Nr. Item no. 4000 K	EUR Netto* EUR net*	EUR Brutto** EUR gross**
MODUL L 196 SEQUENCE 2 Pendelleuchte Suspended luminaire		LED-Technologie LED technology 6800 g 47 W, 24 V DC ~ 6600 lm IP 20	ohne Konverter without converter ohne Aufbaueinheit without ceiling-mounted housing Aluminium eloxiert anodised aluminium	545-850	545-633	545-852	1.859,00	2.212,21
MODUL L 196 SEQUENCE 2 Pendelleuchte mit Indirektanteil Suspended luminaire with additional indirect light		LED-Technologie LED technology 7000 g 55 W, 24 V DC ~ 7600 lm IP 20	ohne Konverter without converter ohne Aufbaueinheit without ceiling-mounted housing Aluminium eloxiert anodised aluminium	545-853	545-854	545-855	2.124,00	2.527,56
Konverter in separatem Aufbaueinheit Converter in separate ceiling-mounted housing			einfach schaltbar switchable dimmbar, 1–10 V dimmable, 1–10 V dimmbar, DALI/switchDim dimmable, DALI/switchDim	545-864¹	545-864¹	545-864¹	172,00	204,68
				545-865	545-865	545-865	236,00	280,84
				545-866	545-866	545-866	312,00	371,28
				Auf Anfrage mit Upon request with 				
Externer Konverter für Hohlraumbau External converter for cavity mounting	l 300 × b 40 × h 21 mm l 300 × w 40 × d 21 mm	96 W		551-401	551-401	551-401	176,00	209,44
Abdeckplatte für Deckenöffnung Cover for ceiling opening	Ø 110 mm 		weiß white	005-797	005-797	005-797	38,00	45,22
MODUL L 196 SEQUENCE 3 Pendelleuchte Suspended luminaire		LED-Technologie LED technology 11000 g 70,5 W, 24 V DC ~ 9900 lm IP 20	ohne Konverter without converter ohne Aufbaueinheit without ceiling-mounted housing Aluminium eloxiert anodised aluminium	545-856	545-632	545-858	2.853,00	3.395,07
MODUL L 196 SEQUENCE 3 Pendelleuchte mit Indirektanteil Suspended luminaire with additional indirect light		LED-Technologie LED technology 11500 g 82,5 W, 24 V DC ~ 11400 lm IP 20	ohne Konverter without converter ohne Aufbaueinheit without ceiling-mounted housing Aluminium eloxiert anodised aluminium	545-859	545-860	545-861	3.247,00	3.863,93
Konverter in separatem Aufbaueinheit Converter in separate ceiling-mounted housing			einfach schaltbar switchable dimmbar, 1–10 V dimmable, 1–10 V dimmbar, DALI/switchDim dimmable, DALI/switchDim	545-869¹	545-869¹	545-869¹	342,00	406,98
				545-870	545-870	545-870	416,00	495,04
				545-871	545-871	545-871	452,00	537,88
				Auf Anfrage mit Upon request with 				
Externer Konverter für Hohlraumbau External converter for cavity mounting	l 300 × b 40 × h 21 mm l 300 × w 40 × d 21 mm	96 W		551-401	551-401	551-401	176,00	209,44
Abdeckplatte für Deckenöffnung Cover for ceiling opening	Ø 110 mm 		weiß white	005-797	005-797	005-797	38,00	45,22

 Nicht enthaltene Zubehör ist farbig gekennzeichnet.
Accessories not included in delivery are marked in colour.
¹ Dieses Produkt ist auf Anfrage mit ZigBee erhältlich. Informationen ab Seite 21.
¹ Upon request this product is available with ZigBee. Information from page 21.

L 120

Artikel Article	Maße Dimensions	Technik Technology	Ausführung Version	Art.-Nr. Item no. 2700 K	Art.-Nr. Item no. 3000 K	Art.-Nr. Item no. 4000 K	EUR Netto* EUR Brutto** EUR net* EUR gross**
L 120 Pendelleuchte max. 1800 mm Abhängelänge Suspended luminaire max. suspended length 1800 mm		LED-Technologie LED technology 3000 g 32 W, 230 V AC ~ 1826 lm IP 20	mit Konverter im Aufbaugehäuse with converter in ceiling- mounted housing verchromt chrome plated silber-eloxalfarben anodised silver		005-751¹		1.251,00 1.488,69
		LED-Technologie LED technology 3000 g 32 W, 230 V AC ~ 1826 lm IP 20	mit Konverter und Dimmer, 1–10 V im Aufbaugehäuse with converter and dimmer, 1–10 V in ceiling- mounted housing verchromt chrome plated silber-eloxalfarben anodised silver		005-753¹		1.093,00 1.300,67
Auf Anfrage mit Upon request with							
L 120 Pendelleuchte zur Montage an abgehängter Decke (Hohlraum) max. 1800 mm Abhängelänge Suspended luminaire for mounting on suspended ceiling (cavity) max. suspended length 1800 mm		LED-Technologie LED technology 1777 g 26 W, 24 V DC ~ 1826 lm IP 20	ohne Konverter without converter verchromt chrome plated silber-eloxalfarben anodised silver		005-752		1.005,00 1.195,95
		LED-Technologie LED technology 1777 g 26 W, 24 V DC ~ 1826 lm IP 20	ohne Konverter without converter ohne Aufbaugehäuse without ceiling- mounted housing mit Gestendimmung with gesture control verchromt chrome plated		005-754		846,00 1.006,74
Baldachin mit Konverter für L 120 Varianten (24V) Canopy with converter for L 120 variants (24 V)			dimmbar, DALI/switchDIM dimmable, DALI/switchDIM		009-943		473,00 562,87
L 120 Pendelleuchte max. 1800 mm Abhängelänge Suspended luminaire max. suspended length 1800 mm		LED-Technologie LED technology 3000 g 26 W, 24 V DC ~ 1826 lm IP 20	ohne Konverter without converter ohne Aufbaugehäuse without ceiling- mounted housing mit Gestendimmung with gesture control verchromt chrome plated		546-161		1.068,00 1.270,92
Externer Konverter External converter	l 285 × b 57 × h 35 mm l 285 × w 57 × d 35 mm	30 W			006-668		61,00 72,59
Abdeckplatte für Deckenöffnung Cover for ceiling opening					005-797		38,00 45,22

* Der in der Preisliste ausgewiesene Nettopreis versteht sich zzgl. der gesetzlichen Mehrwertsteuer.
 * The net price shown in the price list is without statutory value-added tax.
 ** Der in der Preisliste ausgewiesene Brutttopreis versteht sich inkl. der gesetzlichen Mehrwertsteuer.
 ** The gross price shown in the price list is with statutory value-added tax.

FORCE ONE

Artikel Article	Maße Dimensions	Technik Technology	Ausführung Version	Art.-Nr. Item no. 2700 K	Art.-Nr. Item no. 3000 K	Art.-Nr. Item no. 4000 K	EUR Netto* EUR Brutto** EUR net* EUR gross**
FORCE ONE Stehleuchte floorstanding luminaire		LED-Technologie LED technology 18,6 kg 58 W, 230 V AC ~ 6246 lm IP 20	mit Konverter with converter Präsenz- und Umgebungslichtsensorik Presence detector and ambient light sensor		547-214¹	547-215¹	1.827,00 2.174,13
		LED-Technologie LED technology 18,6 kg 58 W, 230 V AC ~ 6246 lm IP 20	Aluminium weiß hochglänzend aluminium, brilliant white Aluminium eloxiert anodised aluminium Aluminium naturglanzliert aluminium with a natural polished finish		547-211¹	547-212¹	2.010,00 2.391,90
FORCE ONE POWER Stehleuchte floorstanding luminaire		LED-Technologie LED technology 18,6 kg 75 W, 230 V AC ~ 8472 lm IP 20	mit Konverter with converter Präsenz- und Umgebungslichtsensorik Presence detector and ambient light sensor		547-233¹	547-234¹	2.010,00 2.391,90
		LED-Technologie LED technology 18,6 kg 75 W, 230 V AC ~ 8472 lm IP 20	Aluminium weiß hochglänzend aluminium, brilliant white Aluminium eloxiert anodised aluminium Aluminium naturglanzliert aluminium with a natural polished finish		547-236¹	547-237¹	2.193,00 2.609,67
					547-239¹	547-240¹	2.536,00 3.017,84

Nicht enthaltene Zubehör ist farbig gekennzeichnet.
 Accessories not included in delivery are marked in colour.

¹ Dieses Produkt ist auf Anfrage mit ZigBee erhältlich. Informationen ab Seite 21.
¹ Upon request this product is available with ZigBee. Information from page 21.

OFFICE AIR 2.0

Artikel Article	Maße Dimensions	Technik Technology	Ausführung Version	Art.-Nr. Item no. 2700 K	Art.-Nr. Item no. 3000 K	Art.-Nr. Item no. 4000 K	EUR Netto* EUR Brutto** EUR net* EUR gross**
OFFICE AIR 2.0 Stehleuchte, beidseitig abstrahlend Floorstanding luminaire double-sided		LED-Technologie LED technology 23 kg 62,7 W, 230 V AC 8400 lm IP 20	mit Konverter with converter Präsenz- und Tageslichtsteuerung Presence detector and ambient light sensor verchromt chrome plated eloxiert anodised				
				552-368	552-369	2.474,00	2.944,06
				552-373	552-374	2.259,00	2.688,21
OFFICE AIR 2.0 POWER Stehleuchte, beidseitig abstrahlend Floorstanding luminaire double-sided		LED-Technologie LED technology 23 kg 76,3 W, 230 V AC 10700 lm IP 20	mit Konverter with converter Präsenz- und Tageslichtsteuerung Presence detector and ambient light sensor verchromt chrome plated eloxiert anodised				
				552-371	552-372	2.625,00	3.123,75
				552-376	552-377	2.411,00	2.869,09
OFFICE AIR 2.0 Leuchte für USM Haller Tisch, beidseitig abstrahlend Luminaire for USM Haller table, double-sided		LED-Technologie LED technology 10 kg 62,7 W, 230 V AC 8400 lm IP 20	mit Konverter with converter Präsenz- und Tageslichtsteuerung Presence detector and ambient light sensor verchromt chrome plated				
				552-378	552-379	2.474,00	2.944,06
OFFICE AIR 2.0 POWER Leuchte für USM Haller Tisch, beidseitig abstrahlend Luminaire for USM Haller table, double-sided		LED-Technologie LED technology 10 kg 76,3 W, 230 V AC 10700 lm IP 20	mit Konverter with converter Präsenz- und Tageslichtsteuerung Presence detector and ambient light sensor verchromt chrome plated				
				552-380	552-381	2.625,00	3.123,75

ROXXANE

Artikel Article	Maße Dimensions	Technik Technology	Ausführung Version	Art.-Nr. Item no. 2700 K	Art.-Nr. Item no. 3000 K	Art.-Nr. Item no. 4000 K	EUR Netto* EUR Brutto** EUR net* EUR gross**
NEW ROXXANE HOME Leseleuchte, mit Fußplatte Reading luminaire, with baseplate		LED-Technologie LED technology 6,1 kg 2700 K, 10,5 W 3000 K, 10,2 W 4000 K, 9,7 W ~ 900 lm 230 V AC IP 20 CRI > 90	mit Konverter with converter mit Gestensteuerung with gesture control weiß white schwarz black silber-eloxalfarben anodised silver dark bronze dark bronze	558-169	558-173	558-177	695,80 828,00
				558-170	558-174	558-178	695,80 828,00
				558-171	558-175	558-179	695,80 828,00
				558-172	558-176	558-180	695,80 828,00
NEW ROXXANE OFFICE Tischleuchte, ohne Fußplatte Desk luminaire, without baseplate		LED-Technologie LED technology 1,1 kg 2700 K, 15,9 W 3000 K, 15,5 W 4000 K, 14,7 W ~ 1500 lm 230 V AC IP 20 CRI > 90	mit Konverter with converter mit Gestensteuerung with gesture control weiß white schwarz black silber-eloxalfarben anodised silver helleuchrot (NEON) RAL 3026 red (NEON) RAL 3026 dark bronze dark bronze	558-198	558-203	558-208	613,45 730,00
				558-199	558-204	558-209	613,45 730,00
				558-200	558-205	558-210	613,45 730,00
				558-202	558-207	558-212	745,38 887,00
				558-201	558-206	558-211	613,45 730,00
Fußplatte für Roxxane Office Baseplate for Roxxane Office		5,9 kg	weiß white schwarz black silber-eloxalfarben anodised silver helleuchrot (NEON) RAL 3026 red (NEON) RAL 3026 dark bronze dark bronze	558-188	558-188	558-188	84,87 101,00
				558-189	558-189	558-189	84,87 101,00
				558-190	558-190	558-190	84,87 101,00
				558-192	558-192	558-192	102,52 122,00
				558-191	558-191	558-191	84,87 101,00
NEW ROXXANE HOME Tischleuchte, ohne Fußplatte Desk luminaire, without baseplate		LED-Technologie LED technology 700 g 2700 K, 10,5 W 3000 K, 10,2 W 4000 K, 9,7 W ~ 900 lm 230 V AC IP 20 CRI > 90	mit Konverter with converter mit Gestensteuerung with gesture control weiß white schwarz black silber-eloxalfarben anodised silver dark bronze dark bronze	558-145	558-149	558-153	413,45 492,00
				558-146	558-150	558-154	464,71 553,00
				558-147	558-151	558-155	464,71 553,00
				558-148	558-152	558-156	464,71 553,00
Fußplatte für Roxxane Home Tischleuchte Baseplate for Roxxane Home desk luminaire		4,1 kg	weiß white schwarz black silber-eloxalfarben anodised silver dark bronze dark bronze	558-184	558-184	558-184	62,18 74,00
				558-185	558-185	558-185	71,43 85,00
				558-186	558-186	558-186	71,43 85,00
				558-187	558-187	558-187	71,43 85,00

* Der in der Preisliste ausgewiesene Nettopreis versteht sich zzgl. der gesetzlichen Mehrwertsteuer.

** The net price shown in the price list is without statutory value-added tax.

** Der in der Preisliste ausgewiesene Bruttobetrag versteht sich inkl. der gesetzlichen Mehrwertsteuer.

** The gross price shown in the price list is with statutory value-added tax.

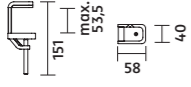
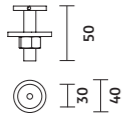
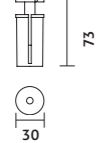
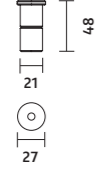
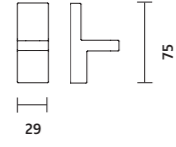

ROXXANE

Artikel Article	Maße Dimensions	Technik Technology	Ausführung Version	Art.-Nr. Item no. 2700 K	Art.-Nr. Item no. 3000 K	Art.-Nr. Item no. 4000 K	EUR Netto* EUR net*	EUR Brutto** EUR gross**
Tischklemme für Roxxane Office und Roxxane Home Tischleuchte Table clamp for Roxxane Office and Roxxane Home desk luminaire			zink zinc	008-768	008-768	008-768	50,42	60,00
Roxxane Universaltischadapter für Roxxane Office und Roxxane Home Tischleuchte Roxanne universal table adapter for Roxxane Office and Roxxane Home desk luminaire				544-110	544-110	544-110	37,82	45,00
Adapter für USM Haller Tischbein bei Tischen ohne Höhenverstellung für USM Haller Tisch, USM Haller Tisch Plus, USM Haller Tisch Access, USM Haller Tisch Advanced für Roxxane Office und Roxxane Home Tischleuchte Adapter for USM Haller table leg for non-height-adjustable tables - for USM Haller Table, USM Haller Table Plus, USM Haller Table Access, USM Haller Table Advanced for Roxxane Office and Roxxane Home desk luminaire				544-109	544-109	544-109	50,42	60,00
Adapter für USM Tische mit Adaptionen für USM Haller Tisch Plus, USM Haller Tisch Advanced, USM Kitos E Plus, USM Kitos E Advanced für Roxxane Office und Roxxane Home Tischleuchte Adapter for USM tables with adaptation points - for USM Haller Table Plus, USM Haller Table Advanced, USM Kitos E Plus, USM Kitos E Advanced for Roxxane Office and Roxxane Home desk luminaire				544-769	544-769	544-769	50,42	60,00
Wandmontage Set für Roxxane Office und Roxxane Home Tischleuchte Wall mounting set for Roxxane Office and Roxxane Home desk luminaire				544-768	544-768	544-768	63,03	75,00

* Der in der Preisliste ausgewiesene Nettopreis versteht sich zzgl. der gesetzlichen Mehrwertsteuer.
* The net price shown in the price list is without statutory value-added tax.

** Der in der Preisliste ausgewiesene Bruttobetrag versteht sich inkl. der gesetzlichen Mehrwertsteuer.
** The gross price shown in the price list is with statutory value-added tax.

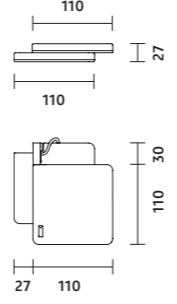
ROXXANE FLY CL

Artikel Article	Maße Dimensions	Technik Technology	Ausführung Version	Art.-Nr. Item no. 2700 K	Art.-Nr. Item no. 3000 K	Art.-Nr. Item no. 4000 K	EUR Netto* EUR net*	EUR Brutto** EUR gross**
ROXXANE FLY CL Kabellose Leuchte Cableless luminaire		LED-Technologie LED technology 560 g F 5 V / USB-Schnittstelle 5 V / USB-interface ~ 75-400 lm IP 20	mit Gestensteuerung und Lithium-Ionen-Akku with gesture control and lithium polymer battery mit USB-Ladekabel, 1,5 m with USB charging cable, 1,5 m					
			weiß white schwarz black rot red gelb (NEON), RAL 1026 yellow (NEON), RAL 1026	550-983			298,32	355,00
				550-981			298,32	355,00
				550-984			298,32	355,00
				550-986			298,32	355,00
USB-Steckernetzteil für Roxxane Fly CL USB plug-in power supply for Roxxane Fly				554-677			35,00	41,65
USB-Ladekabel für Winglet CL / Roxxane Fly CL USB charging cable for Winglet CL / Roxxane Fly C			Länge 1,5 m schwarz length 1.5 m black	554-424			10,10	12,00
Roxxane Fly CL Pad Wandhalterung Roxxane Fly Pad wall bracket	Ø 100 mm 		Stahlblech, weiß gepulvert, selbstklebend auf geeigneten Oberflächen sheet metal, white powdered, self-adhesive on suitable surfaces	551-481			15,13	18,00
Roxxane Fly CL Pad Wandhalterung Roxxane Fly Pad wall bracket	Ø 100 mm 		Stahlblech, weiß gepulvert mit Gewindestift und Dübel sheet metal, white powdered with threaded pin and wall plug	552-236			18,49	22,00

ROXXANE LEGGERA CL

Artikel Article	Maße Dimensions	Technik Technology	Ausführung Version	Art.-Nr. Item no. 2700 K	Art.-Nr. Item no. 3000 K	Art.-Nr. Item no. 4000 K	EUR Netto* EUR Brutto** EUR net* EUR gross**
ROXXANE LEGGERA 52 CL Kabellose Tischleuchte mit Magnetic Dock Cableless desk luminaire with Magnetic Dock		LED-Technologie LED technology 1150 g ~ 25–800 lm IP 20 CRI > 90	mit Magnetic Dock with Magnetic Dock mit Gestensteuerung und Lithium-Ionen-Akku with gesture control and lithium polymer battery mit USB-C Ladekabel with USB-C charging cable				
			weiß matt matt white schwarz matt matt black dark bronze dark bronze basaltgrau matt matt basalt grey rubinrot matt ² matt ruby red ²	552-721			687,39 818,00
				552-719			687,39 818,00
				552-726			800,00 952,00
				552-723			687,39 818,00
				562-191			687,39 818,00
ROXXANE LEGGERA 101 CL Kabellose Leseleuchte mit Magnetic Dock Cableless reading luminaire with Magnetic Dock		LED-Technologie LED technology 1650 g ~ 25–800 lm IP 20 CRI > 90	mit Magnetic Dock with Magnetic Dock mit Gestensteuerung und Lithium-Ionen-Akku with gesture control and lithium polymer battery mit USB-C Ladekabel with USB-C charging cable				
			weiß matt matt white schwarz matt matt black dark bronze dark bronze basaltgrau matt matt basalt grey rubinrot matt matt ruby red graphitgrau matt matt graphite grey	552-720			747,90 890,00
				552-718			747,90 890,00
				552-725			866,39 1.031,00
				552-722			747,90 890,00
				559-023			747,90 890,00
				559-024			747,90 890,00
Magnetic Dock für Roxxane Leggera CL Magnetic Dock for Roxxane Leggera CL		24 V 2 A–50 W		552-706			89,92 107,00
Ersatzakku für Roxxane Leggera CL Replacement battery for Roxxane Leggera CL				561-457			132,00 ¹ 157,08





* Der in der Preisliste ausgewiesene Nettopreis versteht sich zzgl. der gesetzlichen Mehrwertsteuer.
* The net price shown in the price list is without statutory value-added tax.
** Der in der Preisliste ausgewiesene Brutttopreis versteht sich inkl. der gesetzlichen Mehrwertsteuer.
** The gross price shown in the price list is with statutory value-added tax.

ROXXANE LEGGERA CL



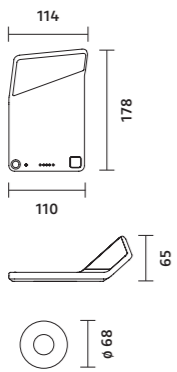

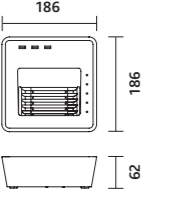
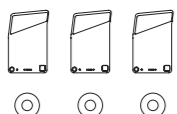
Artikel Article	Maße Dimensions	Technik Technology	Ausführung Version	Art.-Nr. Item no. 2700 K	Art.-Nr. Item no. 3000 K	Art.-Nr. Item no. 4000 K	EUR Netto* EUR Brutto** EUR net* EUR gross**
ROXXANE LEGGERA CL EDITION WALTER KNOLL Kabellose Leseleuchte Cableless reading luminaire		LED-Technologie LED technology 1680 g ~ 25–800 lm IP 20 CRI > 90	mit Magnetic Dock with Magnetic Dock mit Gestensteuerung und Lithium-Ionen-Akku with gesture control and lithium-ion battery mit USB-C Ladekabel with USB-C charging cable				
			Sonderfarbe bronze Walter Knoll special distinctive colour bronze Walter Knoll Sattelleder saddle leather mit handsigniertem Echtheits-Zertifikat with hand-signed certificate of originality	555-030			1.246,22 ¹ 1.483,00
SMARTPHONE HOLDER Adaptive Smartphone Halterung für Roxxane Leggera CL Adaptive smartphone holder for Roxxane Leggera CL		70 g	Kunststoff, schwarz matt Plastic, matt black Soft Touch Beschichtung Soft Touch Coating	554-074			40,34 48,00

¹Bitte beachten: nicht zu Standard-Konditionen rabattierbar.
¹Please note: no discount can be given at standard conditions.
²Lieferbar ab Herbst 2022.
²Available from fall 2022.

WINGLET CL

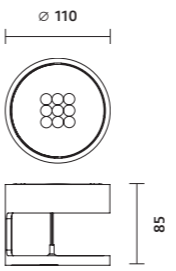
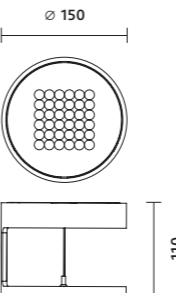
Artikel Article	Maße Dimensions	Technik Technology	Ausführung Version	Art.-Nr. Item no. 2700 K	Art.-Nr. Item no. 3000 K	Art.-Nr. Item no. 4000 K	EUR Netto* EUR net*	EUR Brutto** EUR gross**
WINGLET CL Kabellose Wandleuchten Cableless wall luminaire		LED-Technologie LED technology 5 V DC / Micro-USB- Schnittstelle 5 V DC / Micro-USB interface 250 g ~5 - 170 lm IP 20 CRI > 90	mit Bewegungs- und Helligkeitssensor, mit Funkmodul und Lithium-Ionen-Akku with PDLs control and radio module, with lithium-ion battery	554-908			167,23	199,00
			schwarz matt matt black weiß matt matt white	554-907			167,23	199,00
Wandhalterung für Winglet CL wall bracket for Winglet CL		mit Schraube/Dübel und Klebepad with screw/wallplug and adhesive pad 40 g	weiß white	554-910			26,89	32,00
Basket Charger für Winglet CL Basket Charger for Winglet CL		Eingang 230 V ~ Ausgang 5 x 15 V DC 3 x USB / 5 V DC IP 20 input 230 V AC output 5 x 15 V DC 3 x USB / 5 V DC IP 20 680 g	Ladeschale für bis zu 5 Winglet CL mit Steckernetzteil charging vessel for up to 5 Winglet CL luminaires with power adapter	554-909			167,23	199,00
WINGLET CL SET 3 Set aus 3 Winglet CL set of 3 Winglet CL		LED-Technologie LED technology 5 V DC / Micro-USB- Schnittstelle 5 V DC / with Micro-USB charging cable 250 g ~5 - 170 lm IP 20 CRI > 90	mit Bewegungs- und Helligkeitssensor, mit Funkmodul und Lithium-Ionen-Akku with PDLs control and radio module, with lithium-ion battery	555-727			570,59	679,00
mit Wandhalterungen und Basket Charger with wall brackets and Basket Charger			schwarz matt matt black weiß matt matt white	555-728			570,59	679,00

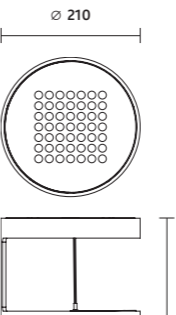
RIM R

Artikel Article	Maße Dimensions	Technik Technology	Ausführung Version	Art.-Nr. Item no. 2700 K	Art.-Nr. Item no. 3000 K	Art.-Nr. Item no. 4000 K	EUR Netto* EUR net*	EUR Brutto** EUR gross**
RIM R 9 Deckenleuchte für Direktmontage Ceiling luminaire for direct mounting		LED-Technologie LED technology 450 g 2700 K, 4,2 W 3000 K, 4,0 W 230 V AC ~ 190 lm IP 20 CRI > 90	mit Konverter with converter	545-672	545-676		473,00	562,87
			chrom hochglänzend brilliant polished chrome	010-205	007-901		373,00	443,87
			weiß hochglänzend brilliant white	010-207	008-186		373,00	443,87
			tonicsilber matt eloxiert frosted silver, anodised	545-673	545-677		373,00	443,87
			titangrau matt eloxiert matt titanium grey, anodised	545-674	545-678		373,00	443,87
			gold matt eloxiert matt gold, anodised	545-675	545-679		373,00	443,87
			graphitschwarz matt eloxiert matt graphite black, anodised					
RIM R 36 Deckenleuchte für Direktmontage Ceiling luminaire for direct mounting		LED-Technologie LED technology 800 g 2700 K, 8,7 W 3000 K, 8,3 W 230 V AC ~ 750 lm IP 20 CRI > 90	mit Konverter with converter	545-716	545-720		599,00	712,81
			chrom hochglänzend brilliant polished chrome	010-201	007-713		487,00	579,53
			weiß hochglänzend brilliant white	010-203	008-200		487,00	579,53
			tonicsilber matt eloxiert frosted silver, anodised	545-717	545-721		487,00	579,53
			titangrau matt eloxiert matt titanium grey, anodised	545-718	545-722		487,00	579,53
			gold matt eloxiert matt gold, anodised	545-719	545-723		487,00	579,53
			graphitschwarz matt eloxiert matt graphite black, anodised					
				Auf Anfrage mit Upon request with  und/and CASAMBI				
RIM R 49 Deckenleuchte für Direktmontage Ceiling luminaire for direct mounting		LED-Technologie LED technology 1400 g 2700 K, 12,4 W 3000 K, 11,8 W 230 V AC ~ 1050 lm IP 20 CRI > 90	mit Konverter with converter	545-702	545-706		749,00	891,31
			chrom hochglänzend brilliant polished chrome	010-209	008-213		624,00	742,56
			weiß hochglänzend brilliant white	010-211	008-214		624,00	742,56
			tonicsilber matt eloxiert frosted silver, anodised	545-703	545-707		624,00	742,56
			titangrau matt eloxiert matt titanium grey, anodised	545-704	545-708		624,00	742,56
			gold matt eloxiert matt gold, anodised	545-705	545-709		624,00	742,56
			graphitschwarz matt eloxiert matt graphite black, anodised					
				Auf Anfrage mit Upon request with  und/and CASAMBI				
		LED-Technologie LED technology 1400 g 2700 K, 12,5 W 3000 K, 11,9 W 230 V AC ~ 1050 lm IP 20 CRI > 90	mit Konverter with converter dimmbar, CASAMBI dimmable, CASAMBI	547-825	547-826		951,00	1.131,69
			chrom hochglänzend brilliant polished chrome	547-844	547-845		825,00	981,75
			weiß hochglänzend brilliant white	547-834	547-835		825,00	981,75
			tonicsilber matt eloxiert frosted silver, anodised	547-841			825,00	981,75
			titangrau matt eloxiert matt titanium grey, anodised	547-828	547-829		825,00	981,75
			gold matt eloxiert matt gold, anodised	547-831	547-832		825,00	981,75
			graphitschwarz matt eloxiert matt graphite black, anodised					

* Der in der Preisliste ausgewiesene Nettopreis versteht sich zzgl. der gesetzlichen Mehrwertsteuer.
* The net price shown in the price list is without statutory value-added tax.
** Der in der Preisliste ausgewiesene Brutttopreis versteht sich inkl. der gesetzlichen Mehrwertsteuer.
** The gross price shown in the price list is with statutory value-added tax.

AIR MAXX SUPER POWER

Artikel Article	Maße Dimensions	Technik Technology	Ausführung Version	Art.-Nr. Item no. 2700 K	Art.-Nr. Item no. 3000 K	Art.-Nr. Item no. 4000 K	EUR Netto* EUR net*	EUR Brutto** EUR gross**
NEW AIR MAXX 130 SUPER POWER		LED-Technologie LED technology 516 g 18 W, 230 V AC ~ 1200 lm IP 20 CRI > 90	mit Konverter und Dimmer, 1–10 V with converter and dimmer, 1–10 V beidseitig abstrahlend double-sided					
Wandleuchte Wall luminaire			chrom hochglänzend brilliant polished chrome tonicsilber matt eloxiert frosted silver, anodised	561-159	561-160		476,00	566,44
				561-157	561-158		422,00	502,18
NEW AIR MAXX 250 SUPER POWER		LED-Technologie LED technology 916 g 33 W, 230 V AC ~ 2300 lm IP 20 CRI > 90	mit Konverter und Dimmer, 1–10 V with converter and dimmer, 1–10 V beidseitig abstrahlend double-sided					
Wandleuchte Wall luminaire			chrom hochglänzend brilliant polished chrome tonicsilber matt eloxiert frosted silver, anodised	561-155	561-156		607,00	722,33
				561-153	561-154		541,00	643,79

MIKE INDIA

Artikel Article	Maße Dimensions	Technik Technology	Ausführung Version	Art.-Nr. Item no. 2700 K	Art.-Nr. Item no. 3000 K	Art.-Nr. Item no. 4000 K	EUR Netto* EUR net*	EUR Brutto** EUR gross**
MIKE INDIA 50 ACCENT		LED-Technologie LED technology 100 g 1,5 W, 24 V DC ~ 55 lm IP 20	ohne Konverter without converter Edelstahl gebürstet brushed stainless steel	010-419	004-024		141,00	167,79
Wandeinbauleuchte für Hohlraumbau Recessed wall-mounted luminaire for cavity mounting								
Wandeinbauleuchte für Einbauset Unterputz/ Mauerwerk Recessed wall-mounted luminaire for flush-mounted installation kit		LED-Technologie LED technology 100 g 1,5 W, 24 V DC ~ 55 lm IP 20	ohne Konverter without converter Edelstahl gebürstet brushed stainless steel	010-425	004-026		141,00	167,79
Einbauset Unterputz/ Mauerwerk ¹ Flush-mounted installation kit ¹			mit Raum für Konverter with space for converter ohne Raum für Konverter without space for converter	004-546	004-546		49,00	58,31
				004-547	004-547		37,00	44,03
MIKE INDIA 50 ACCENT LONG		LED-Technologie LED technology 178 g 3 W, 24 V DC ~ 110 lm IP 20	ohne Konverter without converter Edelstahl gebürstet brushed stainless steel	010-422	004-025		164,00	195,16
Wandeinbauleuchte für Hohlraumbau Recessed wall-mounted luminaire for cavity mounting								
Wandeinbauleuchte für Einbauset Unterputz/ Mauerwerk Recessed wall-mounted luminaire for flush-mounted installation kit		LED-Technologie LED technology 178 g 3 W, 24 V DC ~ 110 lm IP 20	ohne Konverter without converter Edelstahl gebürstet brushed stainless steel	010-428	004-027		164,00	195,16
Einbauset Unterputz/ Mauerwerk ¹ Flush-mounted installation kit ¹			mit Raum für Konverter with space for converter ohne Raum für Konverter without space for converter	004-548	004-548		51,00	60,69
				004-549	004-549		34,00	40,46
MIKE INDIA 70 ACCENT		LED-Technologie LED technology 166 g 3 W, 24 V DC ~ 140 lm IP 20	ohne Konverter without converter Edelstahl gebürstet brushed stainless steel	010-413	003-761		164,00	195,16
Wandeinbauleuchte für Hohlraumbau Recessed wall-mounted luminaire for cavity mounting								
Wandeinbauleuchte für Einbauset Unterputz/ Mauerwerk Recessed wall-mounted luminaire for flush-mounted installation kit		LED-Technologie LED technology 166 g 3 W, 24 V DC ~ 140 lm IP 20	ohne Konverter without converter Edelstahl gebürstet brushed stainless steel	010-414	003-762		164,00	195,16

* Der in der Preisliste ausgewiesene Nettopreis versteht sich zzgl. der gesetzlichen Mehrwertsteuer.

* The net price shown in the price list is without statutory value-added tax.

** Der in der Preisliste ausgewiesene Brutttopreis versteht sich inkl. der gesetzlichen Mehrwertsteuer.

** The gross price shown in the price list is with statutory value-added tax.



¹Datenblatt Einbauset auf nimbus-lighting.com zum Herunterladen verfügbar.

¹Datasheet for installation set available for download at nimbus-lighting.com.

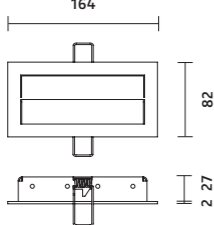
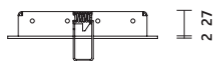
MIKE INDIA

Artikel Article	Maße Dimensions	Technik Technology	Ausführung Version	Art.-Nr. Item no. 2700 K	Art.-Nr. Item no. 3000 K	Art.-Nr. Item no. 4000 K	EUR Netto* EUR net*	EUR Brutto** EUR gross**
Einbauset Unterputz/ Mauerwerk ¹ Flush-mounted installation kit ¹			mit Raum für Konverter with space for converter	003-781	003-781		49,00	58,31
			ohne Raum für Konverter without space for converter	003-780	003-780		34,00	40,46
MIKE INDIA 70 ACCENT LONG		LED-Technologie LED technology 291 g 6 W, 24 V DC ~ 280 lm IP 20	ohne Konverter without converter Edelstahl gebürstet brushed stainless steel	010-415	003-763		213,00	253,47
Wandeinbauleuchte für Hohlraumbau Recessed wall- mounted luminaire for cavity mounting								
Wandeinbauleuchte für Einbauset Unterputz/ Mauerwerk Recessed wall-mounted luminaire for flush- mounted installation kit		LED-Technologie LED technology 291 g 6 W, 24 V DC ~ 280 lm IP 20	ohne Konverter without converter Edelstahl gebürstet brushed stainless steel	010-416	003-764		213,00	253,47
Einbauset Unterputz/ Mauerwerk ¹ Flush-mounted installation kit ¹			mit Raum für Konverter with space for converter	003-783	003-783		54,00	64,26
			ohne Raum für Konverter without space for converter	003-782	003-782		40,00	47,60

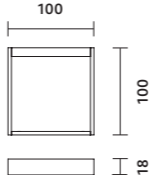
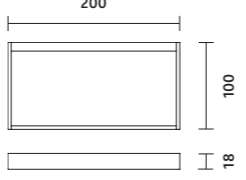
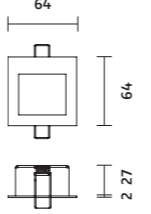
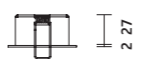

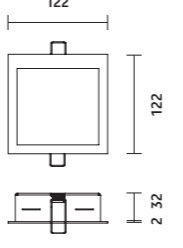

ZEN ON / ZEN IN

Artikel Article	Maße Dimensions	Technik Technology	Ausführung Version	Art.-Nr. Item no. 2700 K	Art.-Nr. Item no. 3000 K	Art.-Nr. Item no. 4000 K	EUR Netto* EUR net*	EUR Brutto** EUR gross**
ZEN ON Wandaufbauleuchte Wall-mounted luminaire		LED-Technologie LED technology 123 g 1,5 W, 24 V DC ~ 85 lm IP 20	ohne Konverter without converter Aluminium natureloxiert naturally anodised aluminium	010-411	004-022		180,00	214,20
ZEN ON LONG Wandaufbauleuchte Wall-mounted luminaire		LED-Technologie LED technology 200 g 3 W, 24 V DC ~ 170 lm IP 20	ohne Konverter without converter Aluminium natureloxiert naturally anodised aluminium	010-412	004-023		208,00	247,52
ZEN IN S Wandeinbauleuchte für Hohlraumbau Recessed wall-mounted luminaire for cavity mounting		LED-Technologie LED technology 86 g 1,5 W, 24 V DC ~ 55 lm IP 20	ohne Konverter without converter Silber-eloxalfarben anodised silver	010-390	003-756		139,00	165,41
Wandeinbauleuchte für Einbauset Unterputz/ Mauerwerk Recessed wall-mounted luminaire for flush- mounted installation kit								
Wandeinbauleuchte für Einbauset Unterputz/ Mauerwerk Recessed wall-mounted luminaire for flush- mounted installation kit		LED-Technologie LED technology 86 g 1,5 W, 24 V DC ~ 55 lm IP 20	ohne Konverter without converter Silber-eloxalfarben anodised silver	010-398	003-757		139,00	165,41
Einbauset Unterputz/ Mauerwerk ¹ Flush-mounted installation kit ¹			mit Raum für Konverter with space for converter	004-546	004-546		49,00	58,31
			ohne Raum für Konverter without space for converter	004-547	004-547		37,00	44,03
ZEN IN M Wandeinbauleuchte für Hohlraumbau Recessed wall-mounted luminaire for cavity mounting		LED-Technologie LED technology 233 g 1,5 W, 24 V DC ~ 85 lm IP 20	ohne Konverter without converter Silber-eloxalfarben anodised silver	010-407	004-018		167,00	198,73
Wandeinbauleuchte für Einbauset Unterputz/ Mauerwerk Recessed wall-mounted luminaire for flush- mounted installation kit		LED-Technologie LED technology 233 g 1,5 W, 24 V DC ~ 85 lm IP 20	ohne Konverter without converter Silber-eloxalfarben anodised silver	010-409	004-020		167,00	198,73
Einbauset Unterputz/ Mauerwerk ¹ Flush-mounted installation kit ¹			mit Raum für Konverter with space for converter	004-542	004-542		54,00	64,26
			ohne Raum für Konverter without space for converter	004-543	004-543		42,00	49,98



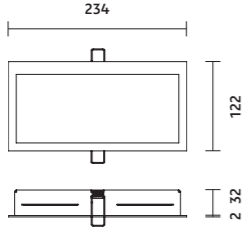

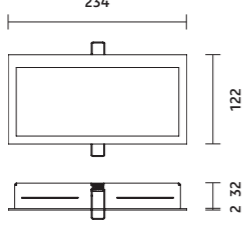
* Der in der Preisliste ausgewiesene Nettopreis versteht sich zzgl. der gesetzlichen Mehrwertsteuer.
 * The net price shown in the price list is without statutory value-added tax.
 ** Der in der Preisliste ausgewiesene Bruttobetrag versteht sich inkl. der gesetzlichen Mehrwertsteuer.
 ** The gross price shown in the price list is with statutory value-added tax.

¹Datenblatt Einbauset auf nimbus-lighting.com zum Herunterladen verfügbar.
¹Datasheet for installation set available for download at nimbus-lighting.com.

ZEN ON / ZEN IN

Artikel Article	Maße Dimensions	Technik Technology	Ausführung Version	Art.-Nr. Item no. 2700 K	Art.-Nr. Item no. 3000 K	Art.-Nr. Item no. 4000 K	EUR Netto* EUR net*	EUR Brutto** EUR gross**
ZEN IN M LONG Wandeinbauleuchte für Hohlraumbau Recessed wall-mounted luminaire for cavity mounting		LED-Technologie LED technology 385 g 3 W, 24 V DC ~ 170 lm IP 20	ohne Konverter without converter Silber-eloxalfarben anodised silver	010-408	004-019		208,00	247,52
Wandeinbauleuchte für Einbauset Unterputz/ Mauerwerk Recessed wall-mounted luminaire for flush- mounted installation kit		LED-Technologie LED technology 385 g 3 W, 24 V DC ~ 170 lm IP 20	ohne Konverter without converter Silber-eloxalfarben anodised silver	010-410	004-021		208,00	247,52
Einbauset Unterputz/ Mauerwerk ¹ Flush-mounted installation kit ¹			mit Raum für Konverter with space for converter	004-544	004-544		66,00	78,54
			ohne Raum für Konverter without space for converter	004-545	004-545		50,00	59,50
ZEN IN M LONG POWER Wandeinbauleuchte für Hohlraumbau Recessed wall-mounted luminaire for cavity mounting		LED-Technologie LED technology 385 g 6 W, 24 V DC ~ 340 lm IP 20	ohne Konverter without converter Silber-eloxalfarben anodised silver	010-400	003-758		240,00	285,60
Wandeinbauleuchte für Einbauset Unterputz/ Mauerwerk Recessed wall-mounted luminaire for flush- mounted installation kit		LED-Technologie LED technology 385 g 6 W, 24 V DC ~ 340 lm IP 20	ohne Konverter without converter Silber-eloxalfarben anodised silver	010-403	003-759		240,00	285,60
Einbauset Unterputz/ Mauerwerk ¹ Flush-mounted installation kit ¹			mit Raum für Konverter with space for converter	004-544	004-544		66,00	78,54
			ohne Raum für Konverter without space for converter	004-545	004-545		50,00	59,50

LOOX5 LED BÄNDER / LOOX5 LED STRIP LIGHTS

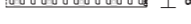
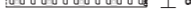
Artikel Article	Maße Dimensions	Technik Technology	Art.-Nr. Item no. 2700 K	Art.-Nr. Item no. 3000 K	Art.-Nr. Item no. 3000 K	Art.-Nr. Item no. 5000 K	EUR Netto* EUR net*	EUR Brutto** EUR gross**
NEW LOOX5 LED BAND 3042 / LOOX5 LED STRIP LIGHT 3042  I ∞ LED Band, Selbstklebend LED strip, Self-adhesive		LED-Technologie LED technology Dimmbar Dimmable Kunststoff, weiß plastic, white Länge 5 m length 5 m 4,8 W/m 120 LEDs/m 2700 K, 440lm/m, F 3000 K, 465 lm/m, F 4000 K, 490 lm/m, F 5000 K, 495 lm/m, F max. Bandlänge (optisch) 12 m ⁽³⁾ max. band length (optical) 12 m ⁽³⁾ 24 V DC IP 20 CRI 90	560-275^{1,2}	560-276^{1,2}	560-277^{1,2}	560-278^{1,2}	141,07	167,87
NEW LOOX5 LED BAND 3045 / LOOX5 LED STRIP LIGHT 3045  I ∞ LED Band, Selbstklebend LED strip, Self-adhesive		LED-Technologie LED technology Dimmbar Dimmable Kunststoff, weiß plastic, white Länge 5 m length 5 m 9,6 W/m 120 LEDs/m 2700 K, 920lm/m, F 3000 K, 970 lm/m, F 4000 K, 1000 lm/m, F 5000 K, 1040 lm/m, F max. Bandlänge (optisch) 8 m ⁽³⁾ max. band length (optical) 8 m ⁽³⁾ 24 V DC IP 20 CRI 90	560-279^{1,2}	560-280^{1,2}	560-281^{1,2}	560-282^{1,2}	183,73	218,64
NEW LOOX5 LED BAND 3048 / LOOX5 LED STRIP LIGHT 3048  I ∞ LED Band, Selbstklebend LED strip, Self-adhesive		LED-Technologie LED technology Dimmbar Dimmable Kunststoff, weiß plastic, white Länge 5 m length 5 m 14,4 W/m 120 LEDs/m 2700 K, 1270 lm/m, G 3000 K, 1305 lm/m, G 4000 K, 1340 lm/m, F 5000 K, 1430 lm/m, F max. Bandlänge (optisch) 6,2 m ⁽³⁾ max. band length (optical) 6,2 m ⁽³⁾ 24 V DC IP 20 CRI 90	560-283^{1,2}	560-284^{1,2}	560-285^{1,2}	560-286^{1,2}	210,99	251,08

* Der in der Preisliste ausgewiesene Nettopreis versteht sich zzgl. der gesetzlichen Mehrwertsteuer.
* The net price shown in the price list is without statutory value-added tax.
** Der in der Preisliste ausgewiesene Bruttobetrag versteht sich inkl. der gesetzlichen Mehrwertsteuer.
** The gross price shown in the price list is with statutory value-added tax.

¹ Zuleitung bitte separat bestellen

² Aluminiumprofil ab 9,6 W/m empfohlen



³ Maximale optische Bandlänge gilt für einen nicht wahrnehmbaren Lichtstromabfall von max. 30%.

Maximale leistungsabhängige Bandlänge abhängig vom Netzteil.

³ Maximum optical strip length applies to an imperceptible drop in luminous flux of 30% at the most.
Maximum performance-dependent strip length depends on power supply unit.





LOOX5 LED BÄNDER / LOOX5 LED STRIP LIGHTS

Artikel Article	Maße Dimensions	Technik Technology	Art.-Nr. Item no. 2700 K	Art.-Nr. Item no. 3000 K	Art.-Nr. Item no. 4000 K	Art.-Nr. Item no. 5000 K	EUR Netto* EUR net*	EUR Brutto** EUR gross**
NEW LOOX5 LED BAND 3050 / LOOX5 LED STRIP LIGHT 3050	 I ∞	LED-Technologie LED technology Dimmbar Dimmable Kunststoff, weiß plastic, white Länge 5 m length 5 m 9,6 W/m 140 LEDs/m 2700 K, 945 lm/m, G 3000 K, 1030 lm/m, F 4000K, 1060lm/m, F 5000 K, 1080lm/m, F max. Bandlänge (optisch) 9 m ⁽⁵⁾ max. band length (optical) 9 m ⁽⁵⁾ 24 V DC IP 20 CRI 90	560-287 ^{1,2}	560-288 ^{1,2}	560-289 ^{1,2}	560-290 ^{1,2}	215,74	256,73
LED Band, Selbstklebend LED strip, Self-adhesive								
NEW LOOX5 LED BAND 3051 / LOOX5 LED STRIP LIGHT 3051	 I ∞	LED-Technologie LED technology IC ⁺ IC ⁺ Dimmbar Dimmable Kunststoff, weiß plastic, white Länge 5 m length 5 m 14,4 W/m 140 LEDs/m 2700 K, 1430 lm/m, F 3000 K, 1520 lm/m, F 4000K, 1605 lm/m, F 5000 K, 1650 lm/m, F max. Bandlänge (optisch) 6,2 m ⁽⁵⁾ max. band length (optical) 6,2 m ⁽⁵⁾ 24 V DC IP 20 CRI 90	560-291 ^{1,2}	560-292 ^{1,2}	560-293 ^{1,2}	560-294 ^{1,2}	248,92	296,21
LED Band, Selbstklebend LED strip, Self-adhesive								
NEW LOOX5 LED BAND 3052 / LOOX5 LED STRIP LIGHT 3052	 I ∞	LED-Technologie LED technology IC ⁺ IC ⁺ Dimmbar Dimmable Kunststoff, weiß plastic, white Länge 5 m length 5 m 19,2 W/m 140 LEDs/m 2700 K, 1850 lm/m, F 3000 K, 2015 lm/m, F 4000K, 2050 lm/m, F 5000 K, 2100 lm/m, F max. Bandlänge (optisch) 4,6 m ⁽⁵⁾ max. band length (optical) 4,6 m ⁽⁵⁾ 24 V DC IP 20 CRI 90	560-295 ^{1,2}	560-296 ^{1,2}	560-297 ^{1,2}	560-298 ^{1,2}	285,66	339,94
LED Band, Selbstklebend LED strip, Self-adhesive								

* Der in der Preisliste ausgewiesene Nettopreis versteht sich zzgl. der gesetzlichen Mehrwertsteuer.
 ** The net price shown in the price list is without statutory value-added tax.
 * Der in der Preisliste ausgewiesene Brutttopreis versteht sich inkl. der gesetzlichen Mehrwertsteuer.
 ** The gross price shown in the price list is with statutory value-added tax.

LOOX5 LED BÄNDER / LOOX5 LED STRIP LIGHTS

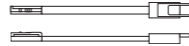

Artikel Article	Maße Dimensions	Technik Technology	Ausführung Version	Art.-Nr. Item no.	EUR Netto* EUR net*	EUR Brutto** EUR gross**
NEW LOOX5 LED BAND 3044 / LOOX5 LED STRIP LIGHT 3044	 I ∞	LED-Technologie LED technology Dimmbar Dimmable Kunststoff, weiß plastic, white Länge 5 m length 5 m TW 2700–5000 K 4,8 W/m 120 LEDs/m 425 lm/m, F max. Bandlänge (optisch) 8,5 m ⁽⁵⁾ max. band length (optical) 8,5 m ⁽⁵⁾ 24 V DC IP 20 CRI 90	Tunable white Tunable white	560-299 ^{1,2}	167,14	198,90
LED Band, Selbstklebend LED strip, Self-adhesive						
NEW LOOX5 LED BAND 3047 / LOOX5 LED STRIP LIGHT 3047	 I ∞	LED-Technologie LED technology Dimmbar Dimmable Kunststoff, weiß plastic, white Länge 5 m length 5 m TW 2700–5000 K 9,6 W/m 120 LEDs/m 825 lm/m, F max. Bandlänge (optisch) 6,5 m ⁽⁵⁾ max. band length (optical) 6,5 m ⁽⁵⁾ 24 V DC IP 20 CRI 90	Tunable white Tunable white	560-300 ^{1,2}	216,93	258,15
LED Band, Selbstklebend LED strip, Self-adhesive						
NEW LOOX5 LED BAND 3049 / LOOX5 LED STRIP LIGHT 3049	 I ∞	LED-Technologie LED technology Dimmbar Dimmable Kunststoff, weiß plastic, white Länge 5 m length 5 m TW 2700–5000 K 14,4 W/m 120 LEDs/m 1230 lm/m, F max. Bandlänge (optisch) 5 m ⁽⁵⁾ max. band length (optical) 5 m ⁽⁵⁾ 24 V DC IP 20 CRI 90	Tunable white Tunable white	560-301 ^{1,2}	250,11	297,63
LED Band, Selbstklebend LED strip, Self-adhesive						
NEW LOOX5 KABEL LED BAND / LOOX5 LED STRIP LIGHT CABLE		Ausführung 24 V DC version for 24 V DC IP20	100 mm 100 mm 500 mm 500 mm 2000 mm 2000 mm	560-331 560-332 560-333	4,75 5,94 7,14	5,65 7,07 8,50
Kabel für LED Bänder monochrom Lead cable for monochrome LED strip lights						
Kabel für tunable white LED Bänder Lead cable for tunable white LED strip lights		Ausführung 24 V DC version for 24 V DC IP20	Tunable white Tunable white 2000 mm 2000 mm	560-334	8,31	9,89

¹ Zuleitung bitte separat bestellen
¹ please order the supply cable separately
² Aluminiumprofil ab 9,6 W/m empfohlen
² aluminium profile recommended from 9,6 W/m
³ Maximale optische Bandlänge gilt für einen nicht wahrnehmbaren Lichtstromabfall von max. 30%.
 Maximale leistungsabhängige Bandlänge abhängig vom Netzteil.
⁴ Maximum optical strip length applies to an imperceptible drop in luminous flux of 30% at the most.
 Maximum performance-dependent strip length depends on power supply unit.
⁴ Maximale optische Bandlänge ist hier ohne Lichtstromabfall
⁴ Maximum optical strip length here without drop in luminous flux

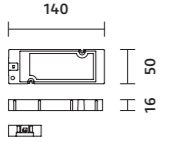
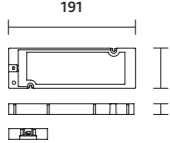
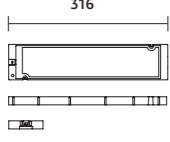
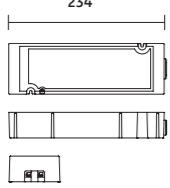

Visit this page for Loox5 LED STRIP LIGHT assembly instructions.

LOOX5 NETZTEILE / LOOX5 POWER SUPPLY UNITS

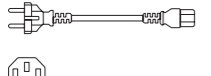
Artikel Article	Maße Dimensions	Technik Technology	Ausführung Version	Art.-Nr. Item no.	EUR Netto* EUR Brutto** EUR net* EUR gross**
NEW LOOX5 NETZTEIL / LOOX5 POWER SUPPLY UNIT Konstantspannung Netzteil Constant voltage power supply unit		Ausgang 1 x Buchse Loox5, 24 V DC output 1 x socket Loox5, 24 V DC 20 W, 230 V AC 50-60 Hz IP 20	20 W 20 W	560-302	34,39 40,92
NEW LOOX5 NETZTEIL / LOOX5 POWER SUPPLY UNIT Konstantspannung Netzteil Constant voltage power supply unit		Ausgang 1 x Buchse Loox5, 24 V DC output 1 x socket Loox5, 24 V DC 40 W, 230 V AC 50-60 Hz IP 20	40 W 40 W	560-303	54,55 64,91
NEW LOOX5 NETZTEIL / LOOX5 POWER SUPPLY UNIT Konstantspannung Netzteil Constant voltage power supply unit		Ausgang 1 x Buchse Loox5, 24 V DC output 1 x socket Loox5, 24 V DC 90 W, 230 V AC 50-60 Hz IP 20	90 W 90 W	560-304	126,83 150,93
NEW LOOX5 NETZTEIL / LOOX5 POWER SUPPLY UNIT Konstantspannung Netzteil Constant voltage power supply unit		Ausgang 1 x Buchse Loox5, 24 V DC output 1 x socket Loox5, 24 V DC 240 W, 230 V AC 50-60 Hz IP 20	240 W 240 W	560-305	263,15 313,15
NEW LOOX5 ZULEITUNG NETZTEIL / LOOX5 MAINS CABLE POWER SUPPLY Zuleitung Netzteil mains cable power supply		Länge 2 m length 2 m IP 20		560-306	5,95 7,08
		Länge 2 m length 2 m IP 20	für 240 W Netzteil for 240 W power supply	560-307	9,50 11,31

LOOX5 CONNECT MESH / LOOX5 CONNECT MESH

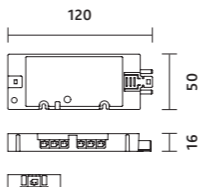
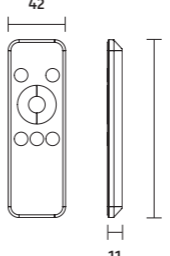
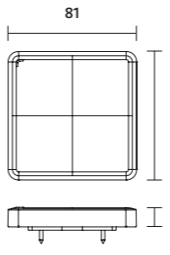
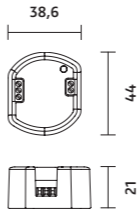
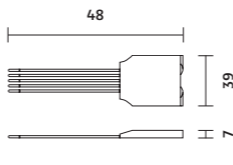
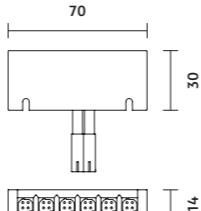
Artikel Article	Maße Dimensions	Technik Technology	Ausführung Version	Art.-Nr. Item no.	EUR Netto* EUR Brutto** EUR net* EUR gross**
NEW LOOX5 CONNECT MESH VERTEILER / LOOX5 CONNECT MESH DISTRIBUTOR 6-fach, mit Schaltfunktion & Bluetooth 6-way distributor, with swit- ching function & Bluetooth		Bluetooth-Technologie Bluetooth technology Ausgang 6 x Buchse Loox5, Ausgang 1 x Buchse Box-to-Box output 6 x socket Loox5, output 1 x socket box- to-box max. angeschlossene Leistung 90 W max. connected wattage 90 W 24 V DC IP 20	ohne Adapter für Multi- Weiß-Leuchten, RGB- Leuchten oder elektrisch betriebene Beschläge without adapter for multi- white lights, RGB lights, or electronically operated fittings	560-308	94,84 112,86
NEW LOOX5 CONNECT MESH FERNBEDIENUNG / LOOX5 CONNECT MESH REMOTE CONTROL für Verteiler Connect Mesh Remote control for the Connect Mesh distributor		Bluetooth-Technologie Bluetooth technology IP 20	mit Lithium Knopfzellen CR2032 with Lithium CR2032 batteries	560-309	79,00 94,01
NEW LOOX5 CONNECT MESH WANDTASTER / LOOX5 CONNECT MESH PUSH BUTTON für Connect Mesh System Push button for Connect Mesh system, wall mounted		Bluetooth-Technologie Bluetooth technology IP 20	mit Lithium Knopfzellen CR2430 with Lithium CR2430 batteries	560-310	70,00 83,30
NEW LOOX5 CONNECT MESH 230V SCHNITTSTELLE / LOOX5 CONNECT MESH INTERFACE für Connect Mesh System Interface for Connect Mesh system		Bluetooth-Technologie Bluetooth technology		560-311	75,87 90,29
NEW LOOX5 CONNECT MESH SCHNITTSTELLE / LOOX5 CONNECT MESH INTERFACE für Verteiler Connect Mesh, batteriebetrieben Interface for Connect Mesh distributor, battery operated		Bluetooth-Technologie Bluetooth technology IP 20	mit 4 Schalteingängen with 4 switching inputs	560-312	47,43 56,44
NEW LOOX5 ADAPTER TUNABLE WHITE / LOOX5 ADAPTER TUNABLE WHITE Adapter für Verteiler Connect Mesh, Tunable white adapter for Connect Mesh distributor		Ausgang 6 x Buchse Loox5 TW output 6 x socket Loox5 TW Kunststoff, schwarz plastic black max. Belastbarkeit 90 W max. load 90 W IP 20	ohne Schaltfunktion without switching function	560-336	11,86 14,11

* Der in der Preisliste ausgewiesene Nettopreis versteht sich zzgl. der gesetzlichen Mehrwertsteuer.
* The net price shown in the price list is without statutory value-added tax.

** Der in der Preisliste ausgewiesene Brutttopreis versteht sich inkl. der gesetzlichen Mehrwertsteuer.
** The gross price shown in the price list is with statutory value-added tax.

LOOX5 PROFILE / LOOX5 PROFILES

Artikel Article	Maße Dimensions	Technik Technology	Ausführung Version	Art.-Nr. Item no.	EUR Netto* EUR net*	EUR Brutto** EUR gross**
NEW LOOX5 PROFIL 1103 / LOOX5 PROFILE 1103		Länge 3 m length 3 m Lichttransmission 70-80% light transmission 70-80%	mit Streuscheibe weiß opal with white opal diffuser schwarz Aluminium eloxiert anodised black aluminium silber Aluminium eloxiert anodised silver aluminium	560-313 560-315	39,13 37,94	46,56 45,15
Einbauprofil für LED-Bänder Recessed profile for LED strip mounting						
NEW LOOX5 PROFIL 2102 / LOOX5 PROFILE 2102		Länge 3 m length 3 m Lichttransmission 70-80% light transmission 70-80%	mit Streuscheibe weiß opal with white opal diffuser schwarz Aluminium eloxiert anodised black aluminium silber Aluminium eloxiert anodised silver aluminium edelstahlfarben Aluminium eloxiert anodised stainless steel colored aluminium	560-318 560-319 560-320	39,13 37,94 41,50	46,56 45,15 49,39
Unterbauprofil für LED-Bänder Profile for surface LED strip mounting						
NEW LOOX5 PROFIL 2103 / LOOX5 PROFILE 2103		Länge 3 m length 3 m Lichttransmission 70-80% light transmission 70-80%	mit Streuscheibe weiß opal with white opal diffuser schwarz Aluminium eloxiert anodised black aluminium silber Aluminium eloxiert anodised silver aluminium edelstahlfarben Aluminium eloxiert anodised stainless steel colored aluminium	560-324 560-325 560-326	45,05 41,50 48,61	53,61 49,39 57,85
Unterbauprofil für LED-Bänder Profile for surface LED strip mounting						

LOOX5 PROFILE / LOOX5 PROFILES

Artikel Article	Maße Dimensions	Technik Technology	Ausführung Version	Art.-Nr. Item no.	EUR Netto* EUR net*	EUR Brutto** EUR gross**
NEW LOOX5 ENDKAPPE 1103 / LOOX5 END CAP 1103		10 Stück 10 pieces Kunststoff plastic	mit Kabeldurchlass with cable outlet	560-316 560-317	5,70 5,70	6,78 6,78
Endkappe für Profile 1103 End cap for Profile 1103						
NEW LOOX5 ENDKAPPE 2102 / LOOX5 END CAP 2102		10 Stück 10 pieces Kunststoff plastic	mit Bohrmarkierung für Kabeldurchlass with drill mark for cable outlet	560-321 560-322 560-323	5,70 5,70 5,70	6,78 6,78 6,78
Endkappe für Profile 2102 End cap for Profile 2102						
NEW LOOX5 ENDKAPPE 2103 / LOOX5 END CAP 2103		10 Stück 10 pieces Kunststoff plastic	mit Bohrmarkierung für Kabeldurchlass with drill mark for cable outlet	560-327 560-328 560-329	5,70 5,70 5,70	6,78 6,78 6,78
Endkappe für Profile 2103 End cap for Profile 2103						
NEW LOOX5 MONTAGEKLAMMER 2103 / LOOX5 MOUNTING BRACKET 2103		10 Stück 10 pieces	edelstahl stainless steel	560-330	5,70	6,78
zur verdeckten Befestigung Mounting bracket for Profile 2103, concealed fixing						

* Der in der Preisliste ausgewiesene Nettopreis versteht sich zzgl. der gesetzlichen Mehrwertsteuer.

* The net price shown in the price list is without statutory value-added tax.

** Der in der Preisliste ausgewiesene Bruttobetrag versteht sich inkl. der gesetzlichen Mehrwertsteuer.

** The gross price shown in the price list is with statutory value-added tax.

LOOX5 VERTEILER / LOOX5 DISTRIBUTOR

Artikel Article	Maße Dimensions	Technik Technology	Ausführung Version	Art.-Nr. Item no.	EUR Netto* EUR net*	EUR Brutto** EUR gross**
<p>NEW LOOX5 VERTEILER / LOOX5 DISTRIBUTOR</p> <p>6 fach Verteiler, 6 way distributor</p>		<p>max. Belastbarkeit 90 W max. load 90 W IP 20</p>	<p>ohne Schaltfunktion without switching function</p>	560-335	7,14	8,50

* Der in der Preisliste ausgewiesene Nettopreis versteht sich zzgl. der gesetzlichen Mehrwertsteuer.

* The net price shown in the price list is without statutory value-added tax.

** Der in der Preisliste ausgewiesene Bruttobetrag versteht sich inkl. der gesetzlichen Mehrwertsteuer.

** The gross price shown in the price list is with statutory value-added tax.

STEUEREINHEITEN CASAMBI / CONTROL UNITS CASAMBI

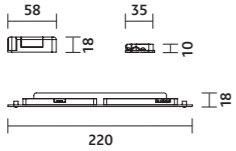
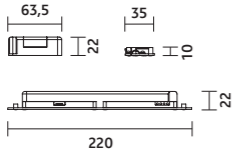
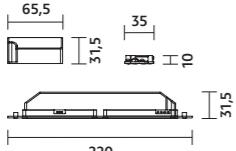
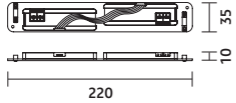
Artikel Article	Maße (l × b × h) Dimensions (l × w × d)	Ausführung Version	Art.-Nr. Item no.	EUR Netto* EUR Brutto** EUR net* EUR gross**
Nimbus CASAMBI 30 W 	ca. 220x35x18 mm (Dimmer- und Funkeinheit) ca. 220x58x18 mm (Konverter) approx. 220x18x35 mm (dimmer and radio unit) approx. 220x18x58 mm (converter)	Steuereinheit mit Konverter, Dimmer und Funkeinheit (Funkeinheit steuerbar über Bluetooth 4.0 ¹), vollständig verkabelt und anschlussbereit Control unit with converter, dimmer and radio unit (radio unit can be controlled via Bluetooth 4.0 ¹), all wired up and ready to connect	547-401	229,00 272,51
Nimbus CASAMBI 50 W 	ca. 220x35x10 mm (Dimmer- und Funkeinheit) ca. 220x63,5x22 mm (Konverter) approx. 220x35x10 mm (dimmer and radio unit) approx. 220x63,5x22 mm (converter)	Steuereinheit mit Konverter, Dimmer und Funkeinheit (Funkeinheit steuerbar über Bluetooth 4.0 ¹), vollständig verkabelt und anschlussbereit Control unit with converter, dimmer and radio unit (radio unit can be controlled via Bluetooth 4.0 ¹), all wired up and ready to connect	547-402	267,00 317,73
Nimbus CASAMBI 100 W 	ca. 220x35x10 mm (Dimmer- und Funkeinheit) ca. 220x65,5x31,5 mm (Konverter) approx. 220x35x10 mm (dimmer and radio unit) approx. 220x65,5x31,5 mm (converter)	Steuereinheit mit Konverter, Dimmer und Funkeinheit (Funkeinheit steuerbar über Bluetooth 4.0 ¹), vollständig verkabelt und anschlussbereit Control unit with converter, dimmer and radio unit (radio unit can be controlled via Bluetooth 4.0 ¹), all wired up and ready to connect	547-403	367,00 436,73
Nimbus CASAMBI Steuereinheit zur Nachrüstung bei bereits vorhandenem Konverter bis 120 W Control unit for retrofitting where there is an existing converter up to 120 W 	ca. 220x35x10 mm (Dimmer- und Funkeinheit) approx. 220x35x10 mm (dimmer and radio unit)	Steuereinheit mit Dimmer und Funkeinheit (Funkeinheit steuerbar über Bluetooth 4.0 ¹), vollständig verkabelt und anschlussbereit Control unit with dimmer and radio unit (radio unit can be controlled via Bluetooth 4.0 ¹), all wired up and ready to connect	547-416	203,00 241,57
Nimbus CASAMBI Kabelloser Wandschalter Wireless wall switch	ca. 90x90x12 mm approx. 90x90x12 mm	weiß white schwarz black	553-572 553-571	249,00 296,31 249,00 296,31

Ausführliche Informationen zu **CASAMBI** zur Nutzung bei bereits vorhandener LED Beleuchtung sowie bebilderte Montageanleitungen finden Sie unter:

www.nimbus-lighting.com/produkte/familien/light-control.

¹Die dazugehörige, kostenlose Casambi-App (Bluetooth 4.0; iOS; Android ab Kitkat 4.4) können Sie im App Store/Play Store herunterladen.

You will find detailed information on **CASAMBI** and its use with existing LED lighting plus illustrated

installation instructions at: www.nimbus-lighting.com/en/products/families/light-control.

¹You can download the required free Casambi app (Bluetooth 4.0; iOS; Android from Kitkat 4.4) from the App Store/Play Store.

*Der in der Preisliste ausgewiesene Nettopreis versteht sich zzgl. der gesetzlichen Mehrwertsteuer.
*The net price shown in the price list is without statutory value-added tax.

**Der in der Preisliste ausgewiesene Bruttobetrag versteht sich inkl. der gesetzlichen Mehrwertsteuer.
**The gross price shown in the price list is with statutory value-added tax.

Aktuelle Konverter-Informationen finden Sie unter nimbus-lighting.com.
See nimbus-lighting.com for the latest information on converters.

INFORMATIONEN ZU KONVERTERN UND DIMMERN / INFORMATION ON CONVERTERS AND DIMMERS

Artikel Article	Leistungsabgabe bis zu Power output up to	Maße (l × b × h) Dimensions (l × w × d)	Art.-Nr. Item no.	EUR Netto* EUR Brutto** EUR net* EUR gross**
KONVERTER CONVERTER	3 W	42 × 40 × 21 mm	546-166	37,00 44,03
	12 W	51,2 × 49 × 27,4 mm	550-618	57,00 67,83
	24 V 24 V	53 × 51 × 24,5 mm	552-085	71,00 84,49
	20 W ⁴	109 × 50 × 35 mm	005-551	69,00 82,11
	35 W ⁴	220 × 40 × 21 mm	550-843	102,00 121,38
	50 W	224,6 × 60 × 36 mm	009-442	121,00 143,99
	60 W	250 × 40 × 21 mm	550-842	130,00 154,70
	70 W	225 × 60 × 36 mm	555-433	126,00 149,94
	75 W	220 × 47 × 44 mm	005-563	223,00 265,37
	96 W ⁴	300 × 40 × 21 mm	551-401	176,00 209,44
KOMBI KONVERTER¹ COMBI CONVERTER¹	35 W DALI/switchDim 35 W, DALI/switchDim	195 × 43 × 30,2 mm	554-945	122,00 145,18
	60 W DALI/switchDim 60 W, DALI/switchDim	225 × 43 × 30,2 mm	558-082	131,00 155,89
	100 W DALI/switchDim 100 W, DALI/switchDim	295 × 43 × 29,8 mm	553-577	230,00 273,70
	150 W DALI/switchDim 150 W, DALI/switchDim	325 × 43 × 30 mm	555-833	262,00 311,78
	75 W, Phasen-/abschnitt 75 W, leading/trailing edge	185 × 60 × 31 mm	555-916	159,00 189,21
	120 W mit Potentiometer 120 W with potentiometer	83 × 30 × 19 mm	546-280	101,00 120,19
	150 W für Taster 150 W for push-button	156 × 51,5 × 25,5 mm	554-144	108,00 128,52
	24 V 120 W 1–10 V ² 120 W 1–10 V ² 120 W 1–10 V ³ 120 W 1–10 V ³	83 × 30 × 19 mm	005-890	71,00 84,49
	120 W DALI/switchDim 120 W DALI/switchDim	172 × 42 × 20 mm	003-907	180,00 214,20
	120 W DALI/switchDim 120 W DALI/switchDim	172 × 42 × 20 mm	003-909	120,00 145,18

¹Informationen zu den maximalen Leitungslängen zwischen LED-Leuchte(n) und den Kombi Konvertern finden Sie unter: www.nimbus-lighting.com.

¹ See [nimbus-lighting.com](http://www.nimbus-lighting.com) for the latest information on the maximum cable lengths between a LED luminaire/luminaires and the combi converters.

²Handelsüblicher 1–10 V Dimmer oder 100 K Ω Potentiometer (logarithmisch).

² Normal, commercially available 1–10 V dimmer or 100 K Ω potentiometer (logarithmic).

³Handelsüblicher 1–10 V Dimmer oder 100 K Ω Potentiometer (linear).

³ Normal, commercially available 1–10 V dimmer or 100 K Ω potentiometer (linear).

⁴Diese Konverter können nicht in Kombination mit Dimmeinheiten, der 20 Watt Konverter nicht mit der IQ-Technologie, verwendet werden.

⁴ These converters cannot be used in combination with dimmer units; the 20-watt converter cannot be used in combination with IQ technology.

Dimmlevel < 5% können zu Unregelmäßigkeiten im Dimmverhalten der LED-Leuchten führen.
Dimming levels < 5% can cause irregularities in the dimming performance of LED luminaires.

INFORMATIONEN ZU KONVERTERN UND DIMMERN / INFORMATION ON CONVERTERS AND DIMMERS

Art.-Nr. Item no.	Leistungsabgabe bis zu Power output up to	Zugentlastung am Konvertergehäuse Strain relief on converter housing	Einbau in abgehängte Decke Assembly in suspended ceiling	Notlichttauglich* Emergency operation*	Einbau in Unterputzdose Assembly in in-wall mounting kits
KONVERTER CONVERTER					
24 V 24 V					
546-166	3 W	nein no	bauseits zu prüfen to be decided on site	nein no	auf Anfrage on request
550-618	12 W	mit Leitung with cables	bauseits zu prüfen to be decided on site	ja yes	auf Anfrage on request
552-085	18 W	mit Leitung with cables	bauseits zu prüfen to be decided on site	nein no	auf Anfrage on request
005-551	20 W ⁴	ja yes	ja yes	nein no	auf Anfrage on request
550-843	35 W ⁴	ja yes	ja yes	ja yes	auf Anfrage on request
009-442	50 W	ja yes	ja yes	ja yes	nein no
550-842	60 W	ja yes	ja yes	ja yes	auf Anfrage on request
555-433	70 W	ja yes	ja yes	ja yes	nein no
005-563	75 W	mit Leitung with cables	ja yes	nein no	auf Anfrage on request
551-401	96 W	ja yes	ja yes	ja yes	auf Anfrage on request
009-464	150 W	ja yes	ja yes	nein no	nein no

KOMBI KONVERTER¹ KOMBI CONVERTER¹

24 V, DALI/switchDim
24 V, DALI/switchDim

554-945	35 W DALI/switchDim	ja yes	ja yes	nein no	auf Anfrage on request
558-082	60 W DALI/switchDim	ja yes	ja yes	ja yes	auf Anfrage on request
553-577	100 W DALI/switchDim	ja yes	ja yes	ja yes	auf Anfrage on request
555-833	150 W DALI/switchDim	ja yes	ja yes	ja yes	auf Anfrage on request
555-916	75 W, Phasen-/ Abschnitt	ja yes	ja yes	nein no	auf Anfrage on request
	75 W, leading/trailing edge	ja yes	ja yes	nein no	auf Anfrage on request

PWM DIMMEINHEITEN PWM DIMMER UNITS

24 V

546-280	120 W mit Potentiometer 120 W with potentiometer	nein no	bauseits zu prüfen to be decided on site	nein no	auf Anfrage on request
554-144	150 W für Taster 150 W for push-button	nein no	bauseits zu prüfen to be decided on site	nein no	auf Anfrage on request
005-890	120 W 1–10 V ²	nein no	bauseits zu prüfen to be decided on site	nein no	auf Anfrage on request
003-907	120 W 1–10 V ³	ja yes	ja yes	nein no	auf Anfrage on request
003-909	120 W DALI/switchDim	ja yes	ja yes	nein no	auf Anfrage on request
	120 W DALI/switchDim	ja yes	ja yes	nein no	auf Anfrage on request

KOMPATIBILITÄT KONVERTER / CONVERTER COMPATIBILITY

Diese Tabelle zeigt Ihnen, welche Konverter Sie in welchen Nimbus Unterputzsets verbauen können.
This table shows you which converters you can install in which Nimbus in-wall mounting kits.

	3 W	12 W	18 W	20 W
	3 W	12 W	18 W	20 W
	Art.-Nr. Item no.	Art.-Nr. Item no.	Art.-Nr. Item no.	Art.-Nr. Item no.
	546-166	550-618	552-085	005-551
Unterputzsets, Art.-Nr.	004-546	•		
Installation kit, Item no.	004-548	•	•	•
	003-781	•		•
	003-783	•	•	•
	004-542	•	•	•
	004-544	•	•	•

* Geeignet für Notbeleuchtungsanlagen gemäß EN 50172/DIN CDE 0108_100.

* Suitable for use in emergency lighting systems in accordance with EN 50172/DIN VDE 0108_100.

Aktuelle Konverter-Informationen finden Sie unter nimbus-lighting.com.
See nimbus-lighting.com for the latest information on converters.

Dimmlevel <5% können zu Unregelmäßigkeiten im Dimmverhalten der LED-Leuchten führen.
Dimming levels <5% can cause irregularities in the dimming performance of LED luminaires.

¹ Informationen zu den maximalen Leitungslängen zwischen LED-Leuchte(n) und den Kombi Konvertern finden Sie unter: www.nimbus-lighting.com.

¹ See nimbus-lighting.com for the latest information on the maximum cable lengths between a LED luminaire/luminaires and the combi converters.

² Handelsüblicher 1–10 V Dimmer oder 100 K Ω Potentiometer (logarithmisch).

² Normal, commercially available 1–10 V dimmer or 100 K Ω potentiometer (logarithmic).

³ Handelsüblicher 1–10 V Dimmer oder 100 K Ω Potentiometer (linear).

³ Normal, commercially available 1–10 V dimmer or 100 K Ω potentiometer (linear).

⁴ Diese Konverter können nicht in Kombination mit Dimmeinheiten, der 20 Watt Konverter nicht mit der IQ-Technologie, verwendet werden.

⁴ These converters cannot be used in combination with dimmer units; the 20-watt converter cannot be used in combination with IQ technology.

MONTAGEVARIANTEN / MOUNTING OPTIONS

Nimbus LED-Leuchten können auf die unterschiedlichsten Arten montiert werden. (Beispiel Modul Q 36)
Luminaires in the Modul Q series can be mounted in a variety of ways. (Example Modul Q 36)

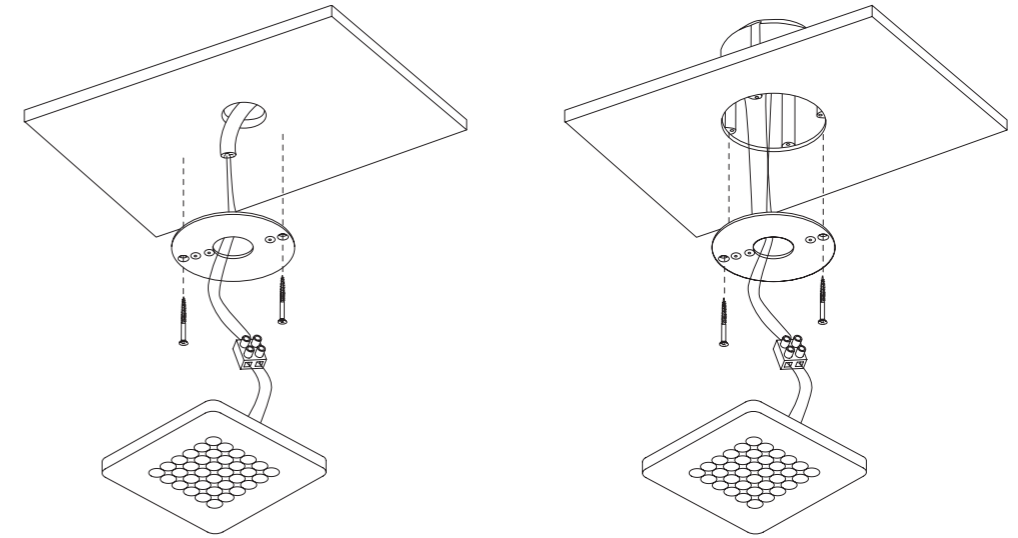

Deckenleuchte für Direktmontage / Ceiling luminaire for directing mounting

Die Montageplatte der Leuchte kann einfach und direkt auf abgehängten Decken montiert werden. Die Leuchte wird über ein einzigartiges Magnetträgersystem an dem Haltering befestigt. Die Leuchte kann somit einfach ausgerichtet und justiert werden. Als weitere Anbauvariante kann die Montageplatte auf die handelsübliche Deckenverbindungsdose montiert werden. Die Leuchte kann ebenso einfach magnetisch daran befestigt werden.

The luminaire mounting plate can be mounted easily and directly on suspended ceilings. The luminaire is fastened to the mounting ring via a unique magnetic support system, making it easy to align and adjust. A further installation option is to mount a magnetic plate on a standard in-wall junction box. The luminaire can also be fastened here magnetically.

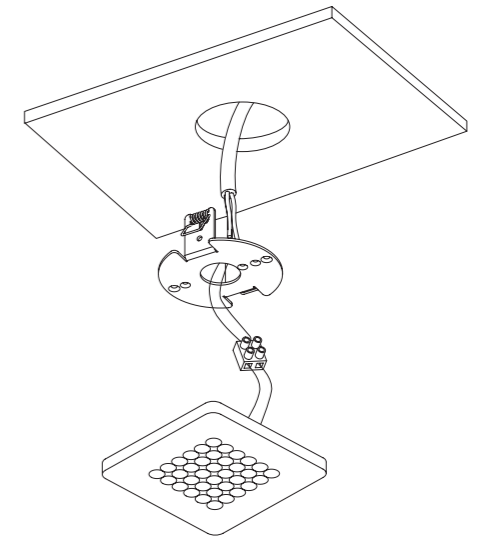

Einbauleuchte für Hohlräummontage / Mounted luminaire for cavity mounting

Die Hohlraumkonsole wird werkzeuglos in die Aussparung in der abgehängten Decke oder den Einbautopf montiert nachdem dort der Konverter eingelegt wurde. Dessen Kabel werden durch die Konsole herausgeführt und mit der Leuchte verbunden. Die Leuchte wird magnetisch gegen die Konsole geclipst.

The cavity bracket is mounted without tools in the recess in the suspended ceiling or in the fitting after the converter has been placed there. The converter cable is guided through the bracket and connected to the luminaire. The luminaire is clipped magnetically to the bracket.

PLANUNGSHINWEISE / PLANNING INFORMATION

- 109 MONTAGEVARIANTEN / MOUNTING OPTIONS
- 111 ANDERE MONTAGEARTEN / OTHER METHODS OF MOUNTING
- 111 LED-LEUCHTEN ANSCHLIESSEN / CONNECTING LED LUMINAIRES
- 112 LEITUNGSLÄNGEN / CABLE LENGTHS
- 112 ANSTEUERBARKEIT EIB/KNX / ACTIVATION CAPABILITY EIB/KNX
- 113 DIMMUNG / DIMMING
- 116 PLANUNGSMATRIX / PLANNING MATRIX

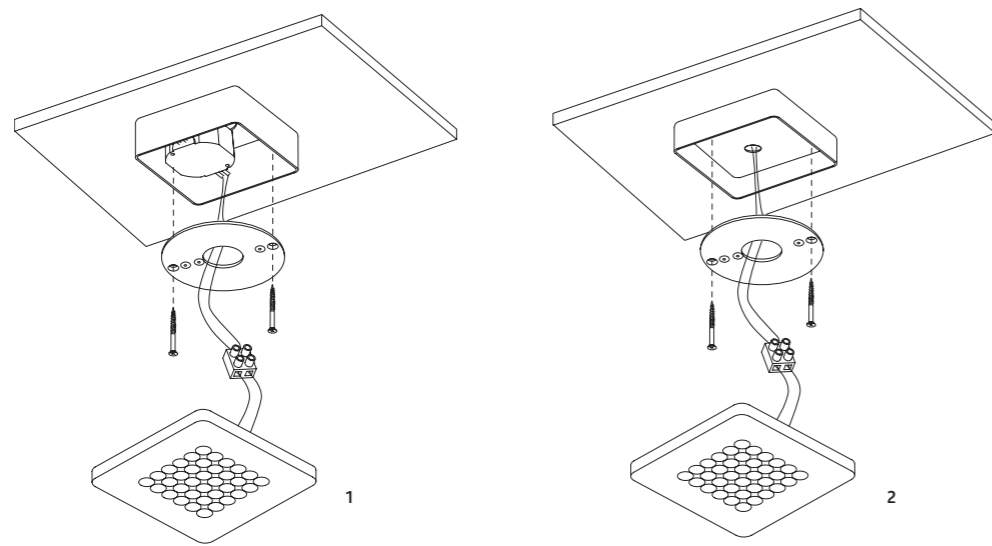

Aufbauleuchte zur Montage mit Aufbaugehäuse / Mounted luminaire for installation with surface-mounted housing

1) Aufbaugehäuse für integrierten Konverter:

Verwenden Sie diese Ausführung, wenn z.B. ein 230 V Deckenauslass vorhanden ist. Zunächst wird das Gehäuse an die Decke geschraubt. Der integrierte Konverter wird mit dem Deckenauslass verbunden. Anschließend wird die Magnetplatte auf die Stehbolzen im Gehäuse verschraubt. Die Leuchte wird gegen die Stahlscheibe geclipst.

2) Aufbaugehäuse ohne Konverter:

Diese Ausführung eignet sich, wenn z.B. ein 24 V Deckenauslass vorhanden ist, der Konverter in die Decke eingelegt werden kann oder der Konverter nicht in der Nähe der Leuchte verbaut ist. Das Aufbaugehäuse dient hierbei als Anschlussraum. Zunächst wird das Gehäuse an die Decke geschraubt. Der 24 V Anschluss wird mit der LED Leuchte verbunden. Anschließend wird die Magnetplatte auf die Stehbolzen im Gehäuse verschraubt. Die Leuchte wird gegen die Stahlscheibe geclipst.

1) Surface-mounted housing for integrated converter:

Use this version if, for example, a 230 V ceiling outlet is available. First of all, the housing is screwed to the ceiling. The integrated converter is connected to the ceiling outlet. The magnetic plate is then screwed to the stud bolts in the housing. The luminaire is clipped to the steel plate.

2) Surface-mounted housing without converter:

This version is appropriate if, for example, a 24 V ceiling outlet is available, the converter can be placed in the ceiling or if the converter is not installed near the luminaire. The surface-mounted housing serves as a connection space. First the housing is screwed to the ceiling. The 24 V connection is connected to the LED luminaire. The magnetic plate is then screwed to the stud bolts in the housing. The luminaire is clipped to steel plate.

ANDERE MONTAGEARTEN / OTHER METHODS OF MOUNTING

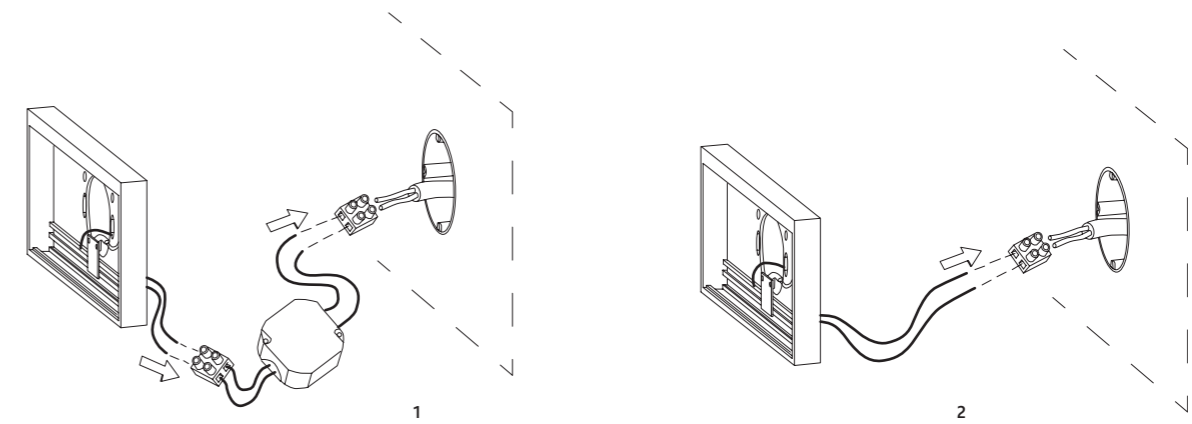

Montage Zen On / Mounting Zen On

- 1) Die Zen On lässt sich direkt auf einer Unterputzdose – wie sie auch für Schalter/Steckdosen verwendet wird – montieren. Der Konverter wird einfach in die (vorhandene) Unterputzdose eingelegt. Die Leuchte wird direkt auf die Wandinbaudose aufgeschraubt. Alternativ kann die Leuchte wie gewohnt an der Wand/Hohlwand verschraubt werden. Eventuell vorhandenen Schutzleiter isolieren und in der Wanddose unterbringen.
- 2) Bei vorhandenem 24 V-Auslass kann die Zen On wie gezeigt montiert werden.

1) The Zen On can be mounted directly on an in-wall junction box – as used for switches/sockets. The converter is simply placed in the (existing) in-wall junction box. The luminaire is screwed directly onto the wall mounting box. Alternatively, the luminaire can be screwed to the wall/cavity wall in the usual way. Insulate possible PE-wire and place it inside of the junction box.

2) If a 24 V output is available, the Zen On can be mounted as shown here.

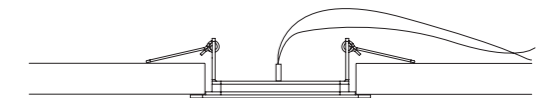

Einbausituation für Hohlraumeinbau / Situation for flush mounting in void

Die Leuchten Modul Q 36 In und Modul Q 64 In lassen sich durch ihre äußerst kompakte Bauweise nahezu bündig in der abgehängten Decke montieren. Die Einbautiefe ist minimal.

Thanks to their extremely compact design, the Modul Q 36 In and Modul Q 64 In luminaires can be mounted almost flush in a suspended ceiling. Installation depth is minimal.

LED-LEUCHTEN ANSCHLIESSEN / CONNECTING LED LUMINAIRES

Grundverschaltung / Connecting up

Für den Anschluss der Nimbus LED Leuchten bitte ausschließlich Nimbus Konverter mit 24 V Gleichspannung verwenden. Handelsübliche Trafos dürfen nicht verwendet werden. Beim Anschluss der Leuchten an die Konverter ist auf die richtige Polung (+/-) zu achten. Mehrere LED Leuchten nur parallel anschließen (siehe Skizze).

Please use only converters with 24 V direct voltage for connecting up Nimbus LED luminaires. Standard transformers may not be used. When connecting luminaires to the converters please make sure the polarity (+/-) is correct. If you have more than one LED luminaire, they may only be connected in parallel (see sketch).

24V Konverter, einfach schaltbar / 24V converter, switchable

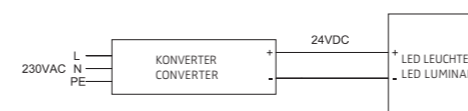

Konverterbetrieb für Einzelleuchte
Converter set up for single luminaire

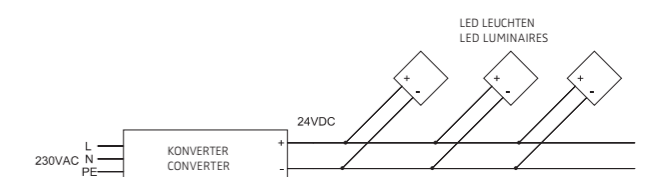

Konverterbetrieb für mehrere, parallel geschaltete Leuchten bis zur max. Leistungsabgabe des Konverters
Converter set up for several luminaires connected in parallel up to the maximum power output of the converter

LEITUNGSLÄNGEN / CABLE LENGTHS

Leitungslängen / Cable Lengths

Die maximalen Leitungslängen zwischen LED-Leuchte(n) und Konverter können Sie aus dieser Tabelle entnehmen. Generell gilt: Je höher die LED-Leistung, desto größer muss der Leitungsquerschnitt sein. Beispiel: Bei einer 24-W-LED-Leuchte und einer 1,0-mm²-Leitung kann die maximale Leitungslänge 28 m betragen.

This table shows the maximum cable lengths between a LED luminaire/luminaires and the converter. The following applies as a general principle: The higher the LED output, the higher the cable cross-section must be. Example: With a 24 W LED luminaire and a 1.0 mm² cable, the maximum cable length is 28 m.

Mögliche Leitungslängen zwischen Leuchte(n) und Konverter bei Kabelquerschnitt

Possible cable lengths between luminaire(s) and converter

	0,75 mm ²	1,0 mm ²	1,5 mm ²	2,5 mm ²
3 W	168 m	224 m	336 m	560 m
6 W	84 m	112 m	168 m	280 m
12 W	42 m	56 m	84 m	140 m
24 W	21 m	28 m	42 m	70 m
60 W	8,3 m	11,1 m	16,7 m	27,8 m
100 W	5 m	6,7 m	10,1 m	16,8 m

Auf den Leitungen darf maximal eine Spannung von 1,0 V abfallen, d.h. an der LED-Leuchte muss mindestens 23,0 V anliegen.

Aus EMV-Gründen soll die Leitung zwischen Dimmer und LED-Leuchte nicht mehr als 10 m betragen.

The maximum voltage drop allowed on the wiring is 1.0 V, i.e. the LED luminaire must always have at least 23.0 V.

Due to EMC considerations, the cable between the dimmer and the LED luminaire should not be longer than 10 m.

ANSTEUERBARKEIT EIB/KNX / ACTIVATION CAPABILITY EIB/KNX

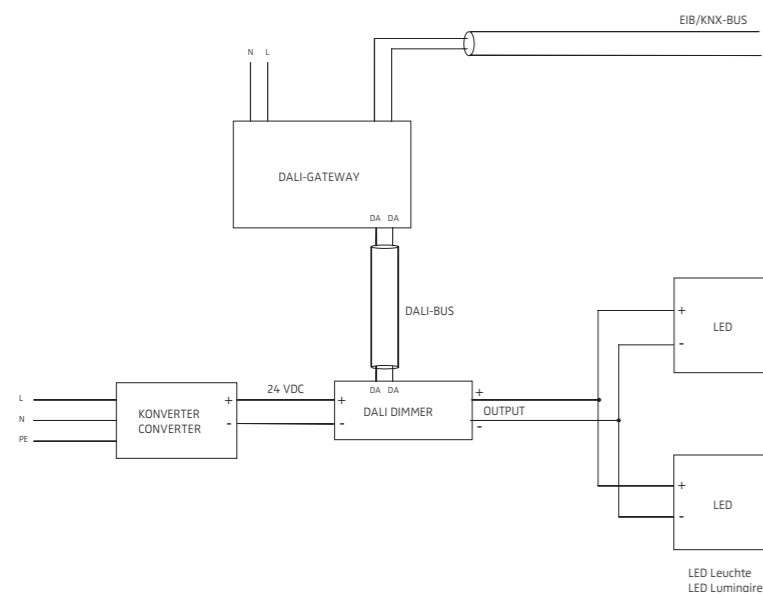

Steuerung von LED-Leuchten über einen EIB/KNX-BUS / Controlling LED luminaires via an EIB/KNX-BUS

Das EIB/KNX-Signal wird mittels eines Gateways in ein DALI-Bus-Signal umgewandelt und steuert so den DALI-Dimmer. Pro Dimmer darf nur ein Konverter verwendet werden.

The EIB/KNX signal is converted to a DALI bus signal using a gateway, thus controlling the DALI dimmer. Only one converter may be used for each dimmer.

DIMMUNG / DIMMING

Dimmen ist bei Nimbus LED-Leuchten möglich. Nahezu alle Nimbus Deckenleuchten werden mit 24-V-Konstantspannung (CV) betrieben. Um die Helligkeit dieser Leuchten verändern zu können, werden Dimmer mit Pulsweitenmodulation-Technologie benötigt. Die Pulsweitenmodulation (PWM) ist energetisch vorteilhaft, da diese nahezu ohne Verlustleistung arbeitet. An einen Konverter können mehrere Dimmer angeschlossen werden, jedoch kann ein Dimmer nur von einem Konverter betrieben werden. Pro Dimmer können nur so viele LED-Leuchten angeschlossen werden, wie die Leistung des Dimmers und des Converters zulässt. Handelsübliche Dimmer, also auch Phasen-/abschnittsdimmer dürfen keinesfalls verwendet werden, da der PWM-Dimmer an die Niederspannungsseite des Converters angeschlossen wird. Eine Ausnahme bildet hier der untenstehende 75-W-Dimmer sowie die Dimmer, die in den neuen FRAME-Gehäusen verbaut werden. Hier werden spezielle Dimmer eingesetzt, die aus einem Phasen-/abschnittssignal ein PWM-Signal erstellen.

Dimming LED luminaires is possible. Almost all Nimbus ceiling luminaires run on 24 V constant voltage (CV). Dimmers with pulse width modulation technology are required to change the brightness level of these luminaires. Pulse width modulation (PWM) brings benefits in terms of power consumption as it works with virtually no power dissipation. Several dimmers can be connected to one converter but one dimmer can only be run by one converter. You may only connect as many LED luminaires to a dimmer as the wattages of the dimmer and converter allow. Standard dimmers, also including forward phase control dimmers or reverse phase control dimmers, may not be used under any circumstances as the PWM dimmer is connected on the low-voltage side of the converter. Exceptions to this rule are the 75 W dimmer indicated below and the dimmers installed in the new FRAME housings, where special dimmers are used that generate a PWM signal from a leading/trailing edge signal.

75 W für Phasen-/abschnittsdimmung (555-916)

75 W for Trailing / leading edge dimmer (555-916)

Nahezu alle Nimbus-Leuchten sind ab sofort über die bestehende Hausinstallation mit 3-adriger Leitung dimmbar! Sie benötigen dazu lediglich einen klassischen Wanddimmer (Phasendimmer, als Tast- oder Drehdimmer) und unseren 75-W-Kombikonverter.

Almost all Nimbus luminaires can now be dimmed via existing building installations with a 3-core cable! All you need is a regular wall dimmer (phase dimmer in either touch or rotary switch) and our 75 W combi converter.

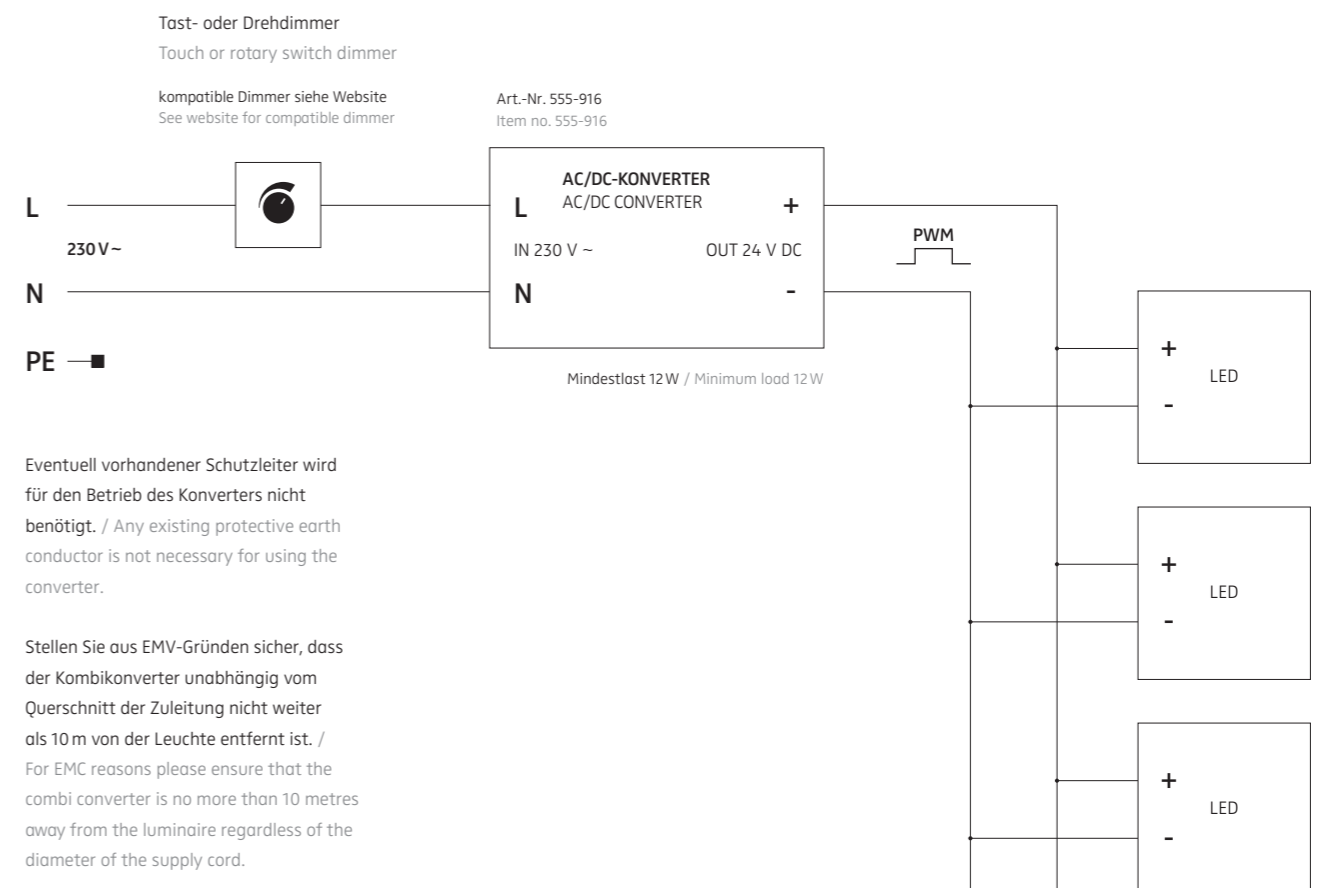

Art.-Nr. 546-280
Item no. 546-280

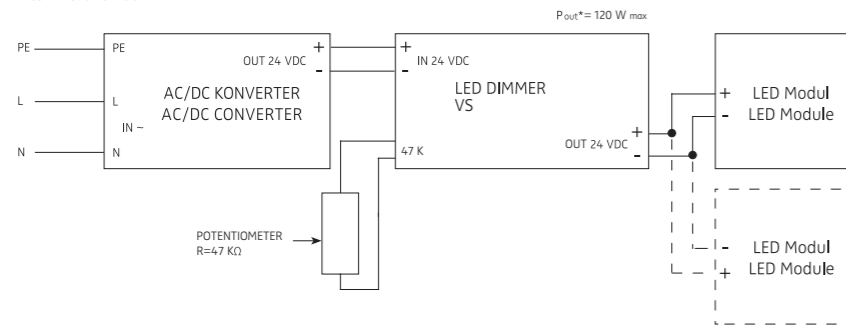

120 W mit Potentiometer (546-280)
120 W with potentiometer (546-280)

Bedienung mittels externem Potentiometer 47K Ω (im Lieferumfang enthalten). Der Betrieb mehrerer LED Dimmer an einem Potentiometer ist nicht möglich.

Operation by means of an external 47K Ω potentiometer (supplied). Several LED dimmers can not be operated on one potentiometer.

Art.-Nr. 554-144
Item no. 554-144

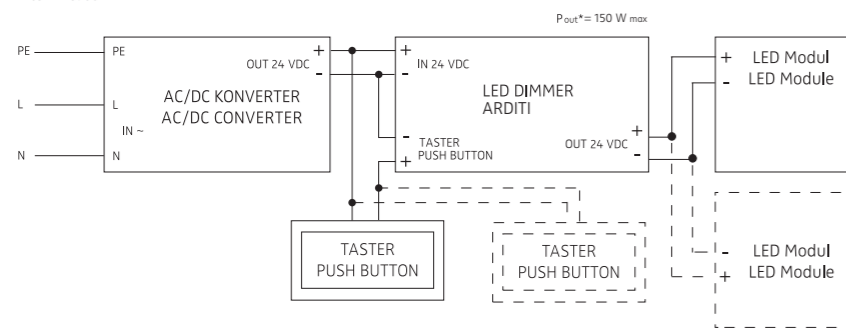

150 W für Taster (554-144)
150 W for button (554-144)

Die Steuerung erfolgt über die 24 V Spannung, die an einem Taster angeschlossen wird. Der Betrieb mehrerer LED-Dimmer über einen Taster ist nicht möglich. Sollen mehrere Dimmer über einen Taster betreiben werden, wird ein zweiter Dimmer in der Slave-Funktion benötigt. Es können jedoch bis zu 10 Taster parallel an einem LED-Dimmer angeschlossen werden. Bei einer Steuerleitung länger als 10 m wird ein geschirmtes Kabel empfohlen. Je nachdem welche anderen Leitungen neben der Dimmleitung liegen.

Control is effected via the 24 V voltage, which is connected to a button. It is not possible to run multiple LED dimmers via one button. If multiple dimmers are to be run via one button, a second dimmer is required in the slave function. However, up to 10 buttons can be connected in parallel to one LED dimmer. If the control wire is longer than 10 m, a shielded cable is recommended, depending on what other wires are next to the dimming wire.

Art.-Nr. 003-907 oder 005-890
Item no. 003-907 or 005-890

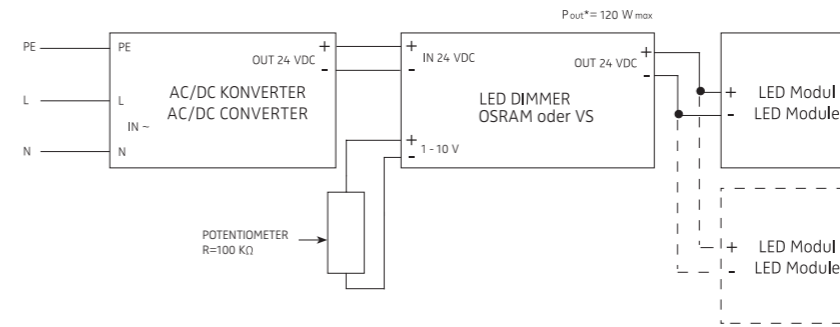

120 W 1-10 V (003-907 oder 005-890)
120 W 1-10 V (003-907 or 005-890)

Die Dimmung kann über die 1-10 V Schnittstelle oder über ein Potentiometer erfolgen.

You can dim via the 1-10 V interface or via a potentiometer.

Art.-Nr. 003-907 oder 005-890
Item no. 003-907 or 005-890

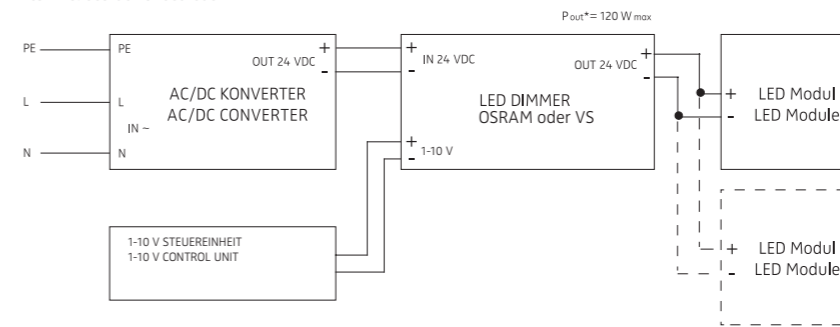

Art.-Nr. 003-909
Item no. 003-909

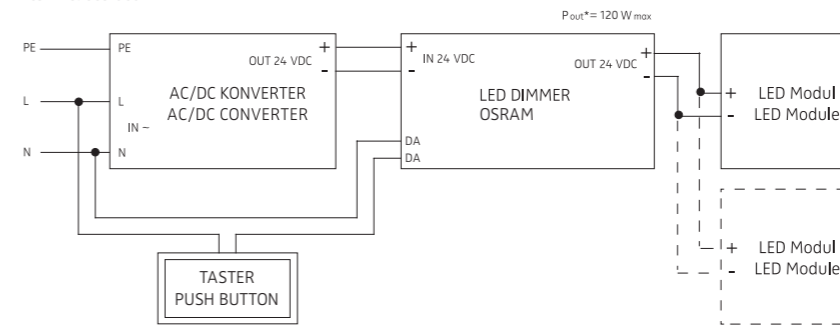

120 W DALI / switchDim (003-909)
120 W DALI / switchDim (003-909)

Die Dimmung kann entweder über die DALI-Schnittstelle erfolgen oder alternativ über einen Taster der die Phase tastet. Bis zu 4 Elektronische Vorschaltgeräte (EVG) können durch Tastbedienung gesteuert werden, wobei die Anzahl der Bedienstellen durch eine Gesamtleitungslänge von 25 m begrenzt ist. Bei Ansteuerung über eine DALI Steuereinheit können bis zu 63 EVGs gedimmt werden. Die maximale Leitungslänge beträgt bei Verwendung von 1,5 mm²-Leitern 300 m.

You can either dim via the DALI interface or, alternatively, via a button that controls the phase. Up to 4 electronic ballasts can be controlled by means of buttons, whereby the number of control positions is limited by a total cable length of 25 m. When controlling via a DALI control unit, up to 63 electronic ballasts can be dimmed. The maximum cable length is 300 m when using 1.5 mm² cables.

Art.-Nr. 003-909
Item no. 003-909

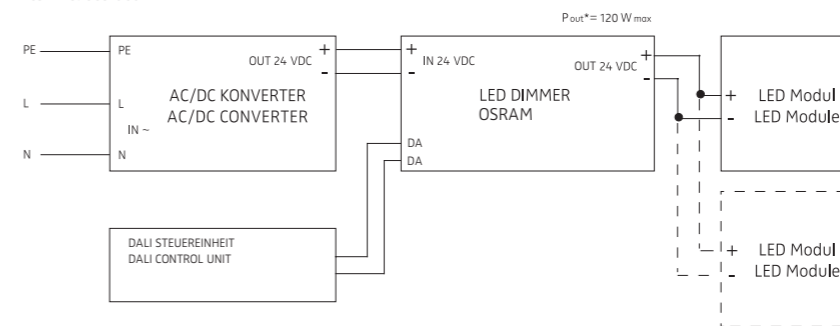

PLANUNGSMATRIX / PLANNING MATRIX

Diese Tabelle/Matrix ermöglicht Ihnen eine übersichtliche Planung für den Einsatz von Nimbus LED Leuchten. Die Werte basieren auf einer Standard-Raumgröße von 25 qm unter Berücksichtigung der Standard-Reflektionsgrade nach DIN (70 %, 50 %, 20 %), dem Wartungsfaktor 0,8 und der Nutzebene 0,85 m.

BEISPIEL:

Die Nimbus LED Leuchten (z.B. Modul Q 36, Modul Q 64, usw.) sind in einem optimalen (definierten) Raster bezogen auf ein 25 qm Segment angeordnet. Über die Parameter Deckenhöhe und gewünschte Beleuchtungsstärke können Sie das empfohlene Anordnungsraster aus der Tabelle herauslesen. Dieses definierte Raster können Sie über Ihre vorhandene Grundfläche legen und ggf. auf die gewünschte Beleuchtungssituation anpassen.

This table/matrix will enable you to carry out rough planning for the installation of Nimbus LED luminaires. The figures are based on a standard room size of 25 sqm, taking into account the standard reflectance according to DIN (70%, 50%, 20%), a maintenance factor of 0.8 and a working plane at 0.85 m.

EXAMPLE:

Nimbus LED luminaires (e.g. Modul Q 36, Modul Q 64, etc.) are arranged in an optimal (defined) grid pattern with respect to a 25 sqm segment. Taking the parameters ceiling height and desired illuminance, you can read the recommended arrangement from the table. You can lay this defined grid pattern over your available floor space and, if necessary, adjust it to the desired lighting situation.

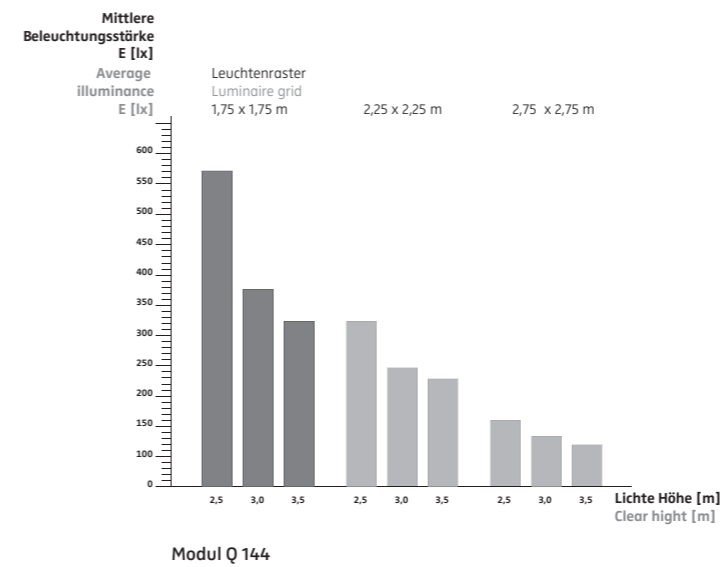
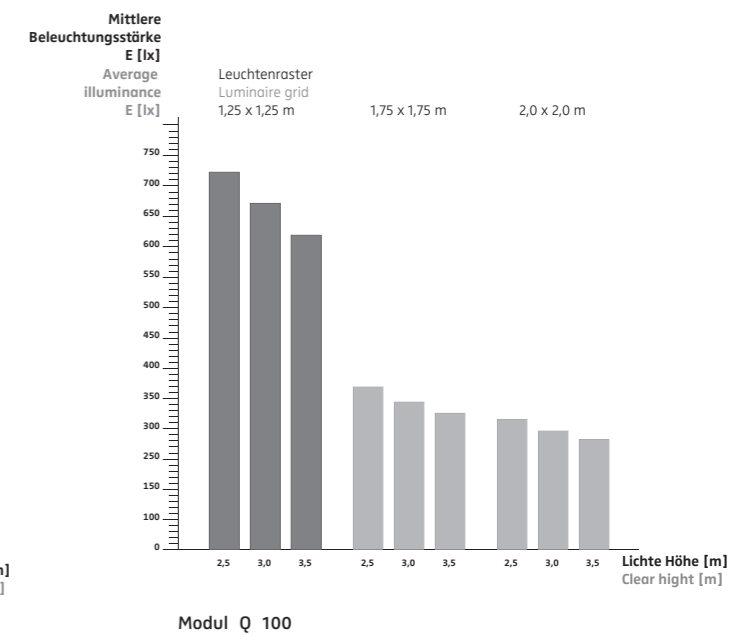
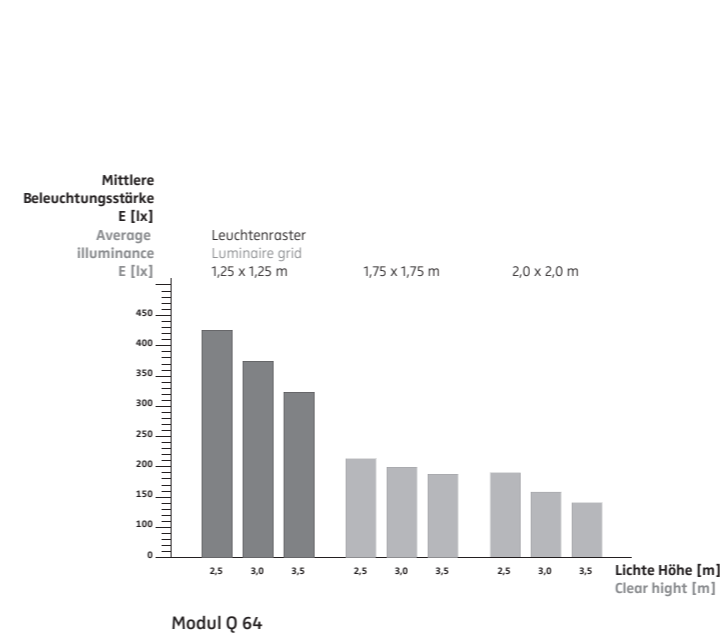
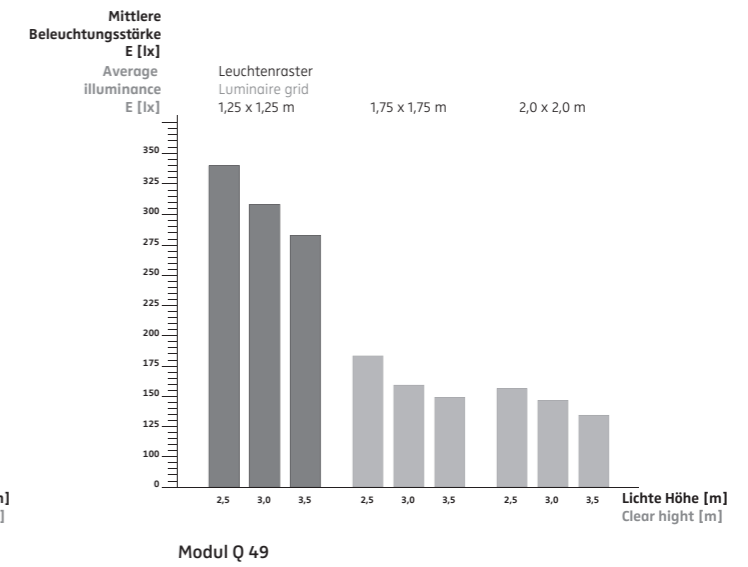
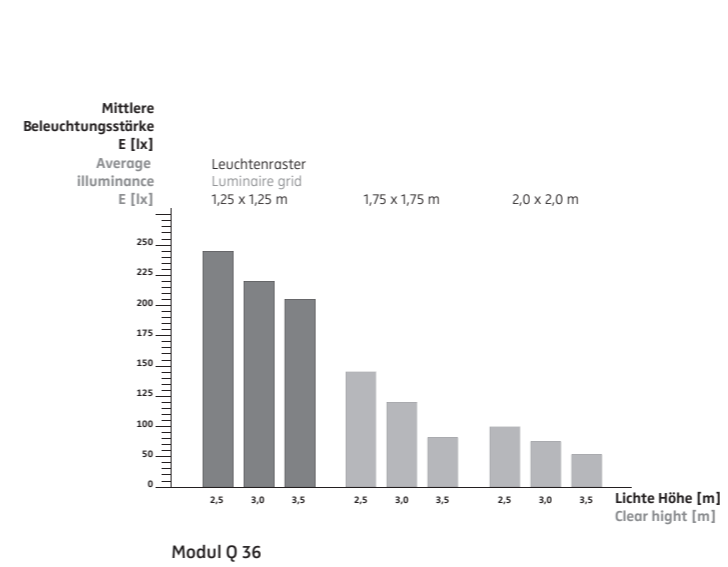

IMPRESSUM / PUBLICATION INFORMATION

Stand: Juli 2022, Nimbus Art.-Nr. 562-410, Häfele Art. Nr. 732.01.713

Konverter sind im Lieferumfang nicht enthalten, falls nicht anders angegeben. Unser Lieferprogramm wird ständig nach den Bedürfnissen des Marktes überarbeitet. Wir bitten um Verständnis, dass wir uns Änderungen in der Gestalt und Technik vorbehalten. Alle technischen Angaben dieses Katalogs unterliegen bauteil- und / oder bauartbedingt einer Toleranz von 10 %.

Es gelten ausschließlich die allgemeinen Geschäftsbedingungen der Nimbus Group, einzusehen unter www.nimbus-group.com. Nimbus verwendet ausschließlich hochwertige und geprüfte Qualitäts- und Markenkomponenten.

Issued: July 2022, Nimbus Item no. 562-410, Häfele Item no. 732.01.713

Unless otherwise indicated, converters are not included in the scope of supply. Our range is constantly revised to keep up with the needs of the market. We reserve the right to make changes to design and technology and apologise for any inconvenience this may cause. All technical details in this catalogue are subject to a tolerance of 10 % due to differences in construction and / or the components used.

The General Terms and Conditions of the Nimbus Group shall apply exclusively. These can be viewed at www.nimbus-group.com. Nimbus only uses high-quality, tested renowned-brand components.

Produktfotografie / Product photos:
Frank Ockert

Fotografenverzeichnis / List of photographers:
Häfele, René Müller (2), DesignRaum (4), Philipp Funke, Jürgen Pollak (5), Alexander Huber / Häfele (6/7), Adolf Bereuter (10/11), Martin Kreuzer (12/13), AKIM photography, Achim Hehn (14/15), Alexander Gebetsroither (15/17), Philipp Funke (18/19)

Konzept, Gestaltung, Layout / Conception, design, layout:
OCKERTUNDPARTNER, Stuttgart, www.oup.studio

Nachdruck, auch nur auszugsweise, nur mit vorheriger schriftlicher Genehmigung der Nimbus Group.

Any reproduction, including extracts, only with prior written consent of the Nimbus Group.

nimbus group

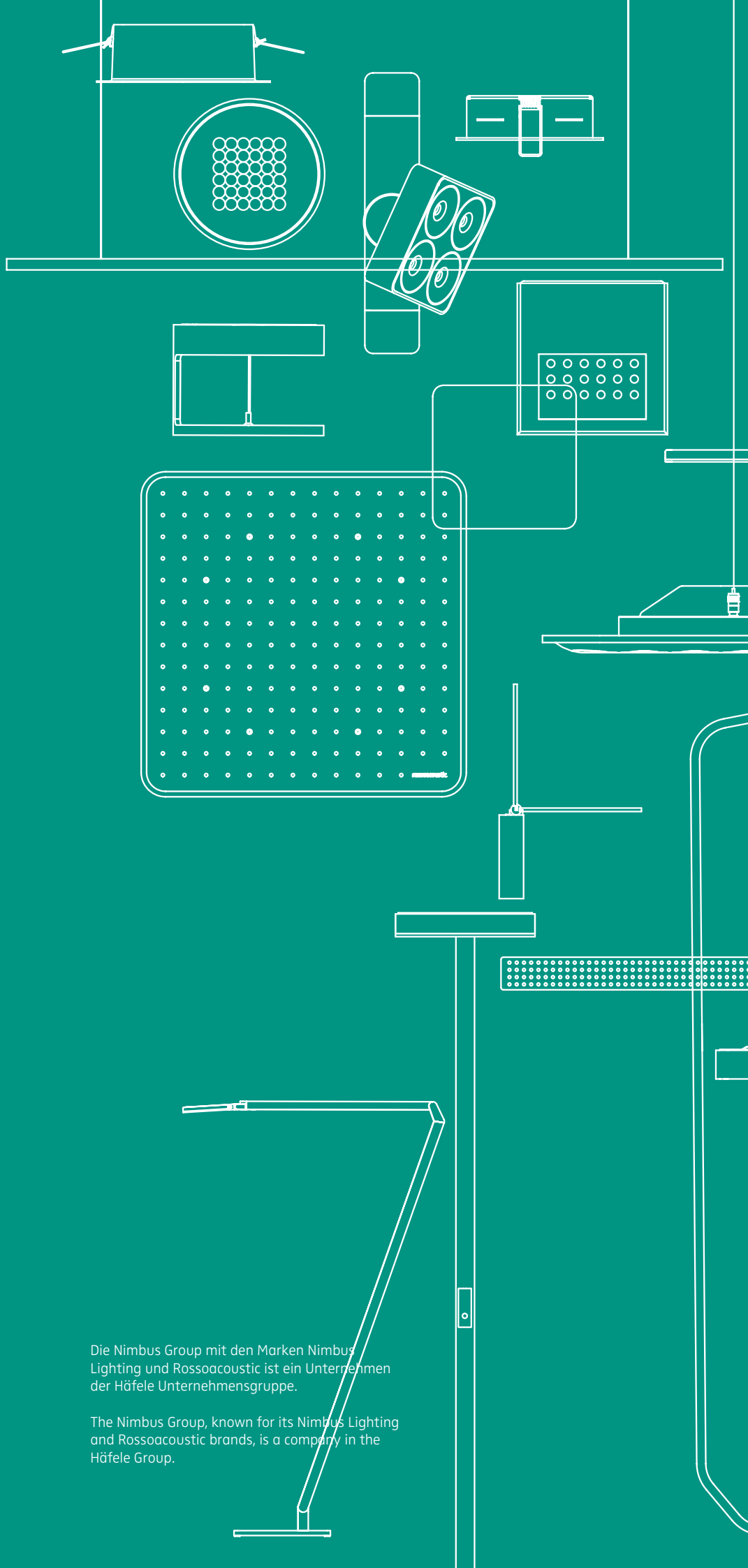

Nimbus Group GmbH
Sieglestraße 41
70469 Stuttgart · Germany
Tel. + 49 (0) 711 63 3014-0
Fax + 49 (0) 711 63 3014-14

www.nimbus-group.com
info@nimbus-group.com

Die Nimbus Group mit den Marken Nimbus Lighting und Rossoacoustic ist ein Unternehmen der Häfele Unternehmensgruppe.

The Nimbus Group, known for its Nimbus Lighting and Rossoacoustic brands, is a company in the Häfele Group.