

FontanaArte

FontanaArte

MILANO 1932

FontanaArte

MILANO 1932

LISTINO / PRICE LIST 2023



FontanaArte nasce a Milano nel 1932 dall'incontro di Gio Ponti, grande padre dell'architettura italiana del Novecento, con Luigi Fontana, imprenditore del vetro in lastra, e Pietro Chiesa, maestro nell'arte vetraria. FontanaArte accompagna l'esplorazione della modernità italiana per cui vetro e metallo sono l'espressione di una nuova idea di bellezza profusa di luce e trasparenze. La sua storia è segnata dalla produzione di lampade e ogni tipo di soluzione che porta la luce nello spazio abitato, una missione senza tempo che si tramanda tra icone e nuovi prodotti.

FontanaArte was founded in Milan in 1932, originating in an encounter between Gio Ponti (the great 20th-century maestro of Italian architecture), Luigi Fontana (entrepreneur of sheet glass) and Pietro Chiesa (a master glass artisan). FontanaArte accompanied Italy's exploration of modernity, where glass and metal expressed a new idea of beauty infused with light and transparency. The history of FontanaArte is distinguished by lamps and every type of object that brought light into the inhabited space. This timeless mission has been passed down from icon to new product.

INDICE / CONTENTS

VISUAL INDEX

p. 7

INDICE PER DESIGNER / INDEX BY DESIGNER

p. 16

VISUAL INDEX PER FAMIGLIA / VISUAL INDEX BY FAMILY

p. 18

LAMPADE DA TAVOLO / TABLE LAMPS

p. 23

LAMPADE DA TERRA / FLOOR LAMPS

p. 49

LAMPADE A PARETE / WALL LAMPS

p. 65

LAMPADE A PLAFONE / CEILING LAMPS

p. 83

LAMPADE A SOSPENSIONE / SUSPENSION LAMPS

p. 93

OUTDOOR

p. 131

ARREDO E VASI / FONITURE AND VASES

p. 137

INFORMAZIONI TECNICHE / TECHNICAL NOTES

p. 145

LAMPADE DA TAVOLO / TABLE LAMPS



3247TA
Historical Archive
p. 25



ASHANGHAI
Max Ingrand
p. 25



BIANCA
Matti Klenell
p. 26



BILIA MINI
Gio Ponti
p. 27



BILIA
Gio Ponti
p. 27



BIS / TRIS
Historical Archive
p. 28



BLOM
Andreas Engesvik
p. 28



CHESHIRE
GamFratesi
p. 29



DARUMA
Sergio Asti
p. 29



EQUATORE
Gabriele e Oscar Buratti
p. 30



FALENA
Alvaro Siza
p. 31



FONTANA
Max Ingrand
p. 31



FONTANELLA
Federico Peri
p. 32



GIOVA
Gae Aulenti
p. 33



KINX
Karim Rashid
p. 34



LASOSPESA
Stefano Boeri Architetti
p. 34



LOOP
Voon Wong & Benson Saw
p. 34



MANO
Pietro Chiesa
p. 35



MATRIX
Studio OS Δ OOS
p. 35



MERIDIANO
Gabriele e Oscar Buratti
p. 36



METAFORA
Umberto Riva
p. 36



NASKA
Historical Archive
p. 37



OORT SISTEMA
Jacopo Roda
p. 40



PALLINA
FontanaArte Design Lab
p. 40



PAROLA
Gae Aulenti e Piero Castiglioni
p. 40



PASSION
Studio Beretta Associati
p. 41



PINECONE
Paola Navone
p. 41



PIRELLINA
Gio Ponti
p. 42



RE
Bobo Piccoli
p. 42



REGINA
Bobo Piccoli
p. 43



SETAREH
Francesco Librizzi
p. 43



THEA
Gabriele e Oscar Buratti
p. 44



THOR
Pagani Perversi Architects
p. 45



TROPICO
Gabriele e Oscar Buratti
p. 45



UOVO
Ben Swildens
p. 46



UOVO RIC/REC
Ben Swildens
p. 47



UOVO OUTDOOR
Ben Swildens
p. 47



VOLÉE
Odo Fioravanti
p. 48



DEMI VOLÉE
Odo Fioravanti
p. 48

LAMPADE DA TERRA / FLOOR LAMPS



0024
Gio Ponti
p. 51



3247
Historical Archive
p. 51



ALICANTO
Francesco Librizzi
p. 52



BIANCA
Matti Klenell
p. 53



CHESHIRE
GamFratesi
p. 53



EQUATORE
Gabriele e Oscar Buratti
p. 54



FALENA
Alvaro Siza
p. 55



FLÛTE
Franco Raggi
p. 55



GALERIE
Federico Peri
p. 56



LUMEN
Historical Archive
p. 57



LUMINATOR
Pietro Chiesa
p. 57



MERIDIANO
Gabriele e Oscar Buratti
p. 58



NASKA XL
Historical Archive
p. 58



OORT SISTEMA
Jacopo Roda
p. 59



PAROLA
Gae Aulenti e Piero Castiglioni
p. 60



PAROLONA
Gae Aulenti e Piero Castiglioni
p. 60



PIRELLONE
Gio Ponti
p. 61



PRIMA SIGNORA
Daniela Puppa
p. 61



RILUMINATOR
Pietro Chiesa
p. 62



SCINTILLA
Livio e Piero Castiglioni
p. 62



THEA
Gabriele e Oscar Buratti
p. 63



TRIPOD
Front Design
p. 63



VERTIGO
Marco Acerbis
p. 64



YUMI
Shigeru Ban
p. 64

LAMPADE A PARETE / WALL LAMPS

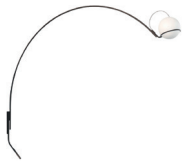

ALICANTO
Francesco Librizzi
p. 67



APEX
Karim Rashid
p. 68



BIANCA
Matti Klenell
p. 68



BONNET
Odo Fioravanti
p. 69



BRUCO
Vico Magistretti
p. 69



FALENA
Alvaro Siza
p. 69



FLEX
Karim Rashid
p. 70



FONTANELLA
Federico Peri
p. 70



FRENESI
Studiolucaguadagnino
p. 71



GALERIE
Federico Peri
p. 71



IO
Claesson Koivisto Rune
p. 71

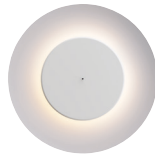

LUNAIRE
Ferréol Babin
p. 72



NASKA
Historical Archive
p. 73



NOBI
Metis Lighting
p. 74



OORT SISTEMA
Jacopo Roda
p. 75



PALLINA
FontanaArte Design Lab
p. 75



PAROLA
Gae Aulenti e Piero Castiglioni
p. 76



RIGA
Paolo Zani
p. 76



SCINTILLA
Livio e Piero Castiglioni
p. 77



SILLABA
Piero Castiglioni
p. 78



SILLABONE
Piero Castiglioni
p. 79



SOLE
Bernardino Amato
p. 80



THEA
Gabriele e Oscar Buratti
p. 80



TROPICO
Gabriele e Oscar Buratti
p. 81

LAMPADE A PLAFONE / CEILING LAMPS



BIANCA
Matti Klenell
p. 85



FONTANELLA
Federico Peri
p. 86



FRENESI
StudioLucaGuadagnino
p. 87



OORT SISTEMA
Jacopo Roda
p. 87



PALLINA
FontanaArte Design Lab
p. 88



PANGEN
Historical Archive
p. 89



SILLABA
Piero Castiglioni
p. 89



SILLABONE
Piero Castiglioni
p. 90



SOLE
Bernardino Amato
pag. 90



THEA
Gabriele e Oscar Buratti
pag. 91



TROPICO
Gabriele e Oscar Buratti
pag. 92

LAMPADE A SOSPENSIONE / SUSPENSION LAMPS



0024
Gio Ponti
p. 95



0024XXL
Gio Ponti
p. 95



AMAX
Charles Williams
p. 96



AVICO
Charles Williams
p. 98



BIANCA
Matti Klenell
p. 99



BOLLA
Studio Harry-Paul
p. 100



CHANDELIER
David Chipperfield
p. 101



CHESHIRE
GamFratesi
p. 102



EQUATORE
Gabriele e Oscar Buratti
p. 103



FONTANELLA
Federico Peri
p. 104



FLÛTE
Franco Raggi
p. 105



GLOBO DI LUCE
Roberto Menghi
p. 107



HUNA
Historical Archive
p. 109



LAMPARA
Historical Archive
p. 109



MERIDIANO
Gabriele e Oscar Buratti
p. 110



OORT SISTEMA
Jacopo Roda
p. 112



PALLINA
FontanaArte Design Lab
p. 116



PANGEN
Historical Archive
p. 116



PAROLA
Gae Aulenti e Piero Castiglioni
p. 117



PINECONE
Paola Navone
p. 117



SCINTILLA
Livio e Piero Castiglioni
p. 119



SERPENTINE
Gabi Peretto
p. 120



SETAREH
Francesco Librizzi
p. 120



THEA
Gabriele e Oscar Buratti
p. 125



TUTTI
Matilde Cassani
p. 126



UOVO
Ben Swildens
p. 130

OUTDOOR



NASKA XL
Historical Archive
p. 133



OORT
Jacopo Roda
p. 133



UOVO RIC/REC
Ben Swildens
p. 136



UOVO OUTDOOR
Ben Swildens
p. 136

ARREDO E VASI / FURNITURE AND VASES



FONTANA
Pietro Chiesa
p. 139



TAVOLINO 1932
Gio Ponti
p. 140



TAVOLO CON RUOTE
Gae Aulenti
p. 140



TOUR
Gae Aulenti
p. 142



TESO
Renzo Piano
p. 143

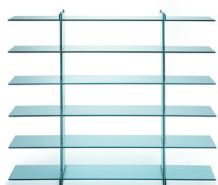

TESO
Renzo Piano
p. 143



TESO
Renzo Piano
p. 144



CARTOCCIO
Pietro Chiesa
p. 144



CARTOCCIO Q
Pietro Chiesa
p. 144

INDICE PER DESIGNER / INDEX BY DESIGNER

ALVARO SIZA

FALENA, p. 31, 55, 69

ANDREAS ENGESVIK

BLOM, p. 28

BEN SWILDENS

UOVO, p. 46, 130

UOVO RICARICABILE /
RECHARGEABLE, p. 47, 136

UOVO OUTDOOR, p. 47, 136

BERNARDINO AMATO

SOLE, p. 80, 90

BOBO PICCOLI

RE, p. 42

REGINA, p. 43

CHARLES WILLIAMS

AMAX, p. 96

AVICO, p. 98

CLAESSON KOIVISTO

RUNE

IO, p. 71

DANIELA PUPPA

PRIMA SIGNORA, p. 61

DAVID CHIPPERFIELD

CHANDELIER, p. 101

FEDERICO PERI

FONTANELLA, p. 32, 70, 86, 104

GALERIE, p. 56, 71

FERRÉOL BABIN

LUNAIRE, p. 72, 87

FONTANAARTE DESIGN LAB

PALLINA, p. 40, 75, 88, 116

FRANCESCO LIBRIZZI

ALICANTO, p. 52, 67

SETAREH, p. 43, 120

FRANCO RAGGI

FLÛTE, p. 55, 105

FRONT DESIGN

TRIPOD, p. 63

GABI PERETTO

SERPENTINE, p. 120

GABRIELE E OSCAR BURATTI

EQUATORE, p. 30, 54, 103

MERIDIANO, p. 36, 58, 110

THEA, p. 44, 63, 80, 91, 125

TROPICO, p. 45, 81, 92

GAE AULENTI

GIOVA, p. 33

PAROLA, p. 40, 60, 76, 117

PAROLONA, p. 60

TAVOLO CON RUOTE, p. 138

TOUR, p. 142

GAMFRATESI

CHESHIRE, p. 29, 53, 102

GIO PONTI

0024, p. 51, 98

BILIA MINI, p. 27

BILIA, p. 27

PIRELLINA, p. 42

PIRELLONE, p. 61

TAVOLINO 1932, p. 140

HISTORICAL

ARCHIVE

3247, p. 25, 51

BIS/TRIS, p. 28

HUNA, p. 109

LAMPARA, p. 109

LUMEN, p. 57

NASKA, p. 37, 73

NASKA XL, p. 58

NASKA XL OUTDOOR, p. 133

PANGEN, p. 87, 116

STUDIO HARRY-PAUL

BOLLA, p. 100

JACOPO RODA

OORT, p. 40, 59, 75, 87, 112

OORT OUTDOOR, p. 133

KARIM RASHID

APEX, p. 68

FLEX, p. 70

KINX, p. 34

LIVIO CASTIGLIONI

SCINTILLA, p. 62, 77, 119

MARCO ACERBIS

VERTIGO, p. 64

MATILDE CASSANI

TUTTI, p. 126

MAX INGRAND

ASHANGHAI, p. 25

FONTANA, p. 31

METIS LIGHTING

NOBI, p. 74

ODO FIORAVANTI

BONNET, p. 69

VOLÉE, p. 48

DEMI VOLÉE, p. 48

STUDIO OS Δ OOS

MATRIX, p. 35

PAGANI PERVERSI ARCHITECTS

THOR, p. 45

PAOLA NAVONE

PINECONE, p. 41, 117

PAOLO ZANI

RIGA, p. 76

PIERO CASTIGLIONI

PAROLA, p. 40, 60, 76, 117

PAROLONA, p. 60

SCINTILLA, p. 62, 77, 119

SILLABA, p. 78, 89

SILLABONE, p. 79, 90

PIETRO CHIESA

CARTOCCIO, p. 144

FONTANA TAVOLINO, p. 139

LUMINATOR, p. 57

MANO, p. 35

RILUMINATOR, p. 62

RENZO PIANO

TESO, p. 143

ROBERTO MENGHI

GLOBO DI LUCE, p. 107

SERGIO ASTI

DARUMA, p. 29

SHIGERU BAN

YUMI, p. 64

STEFANO BOERI

ARCHITETTI

LASOSPESA, p. 34

STUDIO BERETTA

ASSOCIATI

PASSION, p. 41

STUDIOLUCAGUADAGNINO

FRENESI, p. 71, 87

UMBERTO RIVA

METAFORA, p. 36

VICO MAGISTRETTI

BRUCO, p. 69

VOON WONG

& BENSON SAW

LOOP, p. 34

VISUAL INDEX PER FAMIGLIA / VISUAL INDEX BY FAMILY

0024
GIO PONTI



3247
HISTORICAL
ARCHIVE



ALICANTO
FRANCESCO
LIBRIZZI

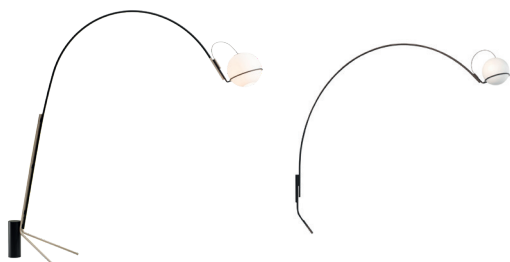

BIANCA
MATTI KLENELL



CHESHIRE
GAMFRATESI



EQUATORE
GABRIELE E OSCAR
BURATTI



FALENA
ALVARO SIZA



FLÛTE
FRANCO RAGGI



FONTANELLA
FEDERICO PERI



GALERIE
FEDERICO PERI



MERIDIANO
GABRIELE E OSCAR
BURATTI



NASKA
HISTORICAL
ARCHIVE



OORT SISTEMA
JACOPO RODA



PALLINA
FONTANAARTE
DESIGN LAB



PANGEN
HISTORICAL
ARCHIVE



PAROLA
GAE AULENTI E PIERO
CASTIGLIONI



PINECONE
PAOLA NAVONE



PIRELLI
GIO PONTI



SCINTILLA
LIVIO E PIERO
CASTIGLIONI



SETAREH
FRANCESCO
LIBRIZZI



THEA
GABRIELE E OSCAR
BURATTI



TROPICO
GABRIELE E OSCAR
BURATTI



UOVO
BEN SWILDENS



LAMPADE DA TAVOLO / TABLE LAMPS

| | | | |
|------------|-------|-----------------------|-------|
| 3247TA | p. 25 | NASKA | p. 37 |
| ASHANGHAI | p. 25 | OORT SISTEMA | p. 40 |
| BIANCA | p. 26 | PALLINA | p. 40 |
| BILIA MINI | p. 27 | PAROLA | p. 40 |
| BILIA | p. 27 | PASSION | p. 41 |
| BIS / TRIS | p. 28 | PINECONE | p. 41 |
| BLOM | p. 28 | PIRELLINA | p. 42 |
| CHESHIRE | p. 29 | RE | p. 42 |
| DARUMA | p. 29 | REGINA | p. 43 |
| EQUATORE | p. 30 | SETAREH | p. 43 |
| FALENA | p. 31 | THEA | p. 44 |
| FONTANA | p. 31 | THOR | p. 45 |
| FONTANELLA | p. 32 | TROPICO | p. 45 |
| GIOVA | p. 33 | UOVO | p. 46 |
| KINX | p. 34 | UOVO RIC. / REC. | p. 47 |
| LASOSPESA | p. 34 | UOVO INDOOR / OUTDOOR | p. 47 |
| LOOP | p. 34 | VOLÉE | p. 48 |
| MANO | p. 35 | DEMI VOLÉE | p. 48 |
| MATRIX | p. 35 | | |
| MERIDIANO | p. 36 | | |
| METAFORA | p. 36 | | |

3247TA
HISTORICAL ARCHIVE
 1954

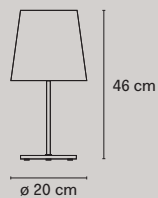

| Codice Code | Materiale Material | Colore Colour | Sorgente luminosa Light source | Dimmer incluso Dimmer included | Classe energetica Energy label | Prezzo Retail con IVA Retail Price VAT incl. |
|----------------|-----------------------------|---------------------------------|--------------------------------|--------------------------------|---|--|
| F324700150KBNE | Vetro, Metallo Glass, Metal | Nichel, Bianco Nickel, White | 1x max 57W E27 | Si Yes | Vedi tabella p. 181 See table p. 181 | 500,00 € |

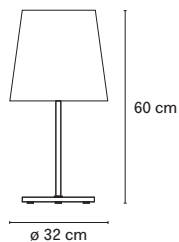

| Codice Code | Materiale Material | Colore Colour | Sorgente luminosa Light source | Dimmer incluso Dimmer included | Classe energetica Energy label | Prezzo Retail con IVA Retail Price VAT incl. |
|----------------|-----------------------------|---------------------------------|--------------------------------|--------------------------------|---|--|
| F324710150KBNE | Vetro, Metallo Glass, Metal | Nichel, Bianco Nickel, White | 1x max 100W E27 | Si Yes | Vedi tabella p. 181 See table p. 181 | 700,00 € |



ASHANGHAI
MAX INGRAND
 1955





| Codice Code | Materiale Material | Colore Colour | Sorgente luminosa Light source | Dimmer incluso Dimmer included | Classe energetica Energy label | Prezzo Retail con IVA Retail Price VAT incl. |
|----------------|-----------------------------|--------------------------------|--------------------------------|--------------------------------|---|--|
| F418805150CBNE | Vetro, Metallo Glass, Metal | Cromo, Bianco Chrome, White | 3x max 30W E14 | Si Yes | Vedi tabella p. 181 See table p. 181 | 2.850,00 € |



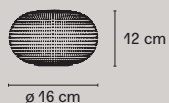

BIANCA
MATTI KLENELL
2015



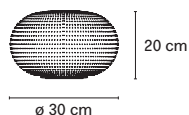

| Codice Code | Materiale Material | Colore Colour | Sorgente luminosa Light source | Dimmer incluso Dimmer included | Classe energetica Energy label | Prezzo Retail con IVA Retail Price VAT incl. |
|---|--------------------------------|-------------------|------------------------------------|---|-----------------------------------|---|
| F430800150BILE | Vetro, Metallo Glass, Metal | ○ Bianco White | LED 4,5W (2700K, CRI>80, 350Lm) | No | F | 325,00 € |
|  | | | LED integrato Integrated LED |  | | |



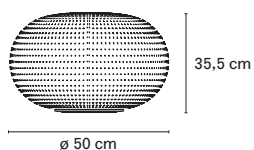







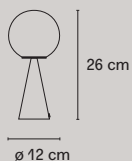

| Codice Code | Materiale Material | Colore Colour | Sorgente luminosa Light source | Dimmer incluso Dimmer included | Classe energetica Energy label | Prezzo Retail con IVA Retail Price VAT incl. |
|---|--------------------------------|-------------------|--------------------------------------|---|-----------------------------------|---|
| F430805150BILE | Vetro, Metallo Glass, Metal | ○ Bianco White | LED 17,5W (2700K, CRI>80, 1650Lm) | Si Yes | E | 530,00 € |
|  | | | LED integrato Integrated LED |  | | |



| Codice Code | Materiale Material | Colore Colour | Sorgente luminosa Light source | Dimmer incluso Dimmer included | Classe energetica Energy label | Prezzo Retail con IVA Retail Price VAT incl. |
|---|--------------------------------|-------------------|-----------------------------------|---|---|---|
| F430810150BINE | Vetro, Metallo Glass, Metal | ○ Bianco White | 1x max 116W E27 | Si Yes | Vedi tabella p. 181 See table p. 181 | 730,00 € |
|  | | | |  | | |

**BILIA
GIO PONTI
1932**



| Codice Code | Materiale Material | Colore Colour | Sorgente luminosa Light source | Dimmer incluso Dimmer included | Classe energetica Energy label | Prezzo Retail con IVA Retail Price VAT incl. |
|----------------|---|---|-----------------------------------|-----------------------------------|---|---|
| F247400150BINE | Vetro, Metallo Glass, Metal |  Bianco White | 1x max 6W G9 | No | Vedi tabella p. 181 See table p. 181 | 320,00 € |
| F247400150BLNE | Vetro, Metallo Glass, Metal |  Blu Blue | 1x max 6W G9 | No | Vedi tabella p. 181 See table p. 181 | 320,00 € |
| F247400150GINE | Vetro, Metallo Glass, Metal |  Giallo Yellow | 1x max 6W G9 | No | Vedi tabella p. 181 See table p. 181 | 320,00 € |
| F247400150KBNE | Vetro, Metallo Glass, Metal |  Nichel, Bianco Nickel, White | 1x max 6W G9 | No | Vedi tabella p. 181 See table p. 181 | 320,00 € |
| F247400150NENE | Vetro, Metallo Glass, Metal |  Nero Black | 1x max 6W G9 | No | Vedi tabella p. 181 See table p. 181 | 320,00 € |
| F247400150RONE | Vetro, Metallo Glass, Metal |  Rosso Red | 1x max 6W G9 | No | Vedi tabella p. 181 See table p. 181 | 320,00 € |
| F247400150VENE | Vetro, Metallo Glass, Metal |  Verde Green | 1x max 6W G9 | No | Vedi tabella p. 181 See table p. 181 | 320,00 € |
| F247400150TBNE | Vetro, Metallo Glass, Metal |  Ottone, Bianco Brass, White | 1x max 6W G9 | No | Vedi tabella p. 181 See table p. 181 | 390,00 € |
| F247400550NENE | Vetro, Metallo Galvanizzato Glass, Gavanized Metal |  Nero lucido Glossy black | 1x max 6W G9 | No | Vedi tabella p. 181 See table p. 181 | 390,00 € |
| F247400550RSNE | Vetro, Metallo Galvanizzato Glass, Gavanized Metal |  Rame lucido Glossy copper | 1x max 6W G9 | No | Vedi tabella p. 181 See table p. 181 | 390,00 € |



CE ENEC Classe II IP20

**BILIA
GIO PONTI
1932**

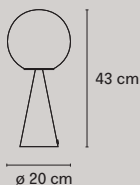



| Codice Code | Materiale Material | Colore Colour | Sorgente luminosa Light source | Dimmer incluso Dimmer included | Classe energetica Energy label | Prezzo Retail con IVA Retail Price VAT incl. |
|----------------|---|---|-----------------------------------|-----------------------------------|---|---|
| F247405150KBNE | Vetro, Metallo Glass, Metal |  Nichel, Bianco Nickel, White | 1x max 46W E14 | Si Yes | Vedi tabella p. 181 See table p. 181 | 590,00 € |
| F247405150TBNE | Vetro, Metallo Glass, Metal |  Ottone, Bianco Brass, White | 1x max 46W E14 | Si Yes | Vedi tabella p. 181 See table p. 181 | 650,00 € |
| F247405550NENE | Vetro, Metallo Galvanizzato Glass, Gavanized Metal |  Nero lucido Glossy black | 1x max 46W E14 | Si Yes | Vedi tabella p. 181 See table p. 181 | 700,00 € |
| F247405550RSNE | Vetro, Metallo Galvanizzato Glass, Gavanized Metal |  Rame lucido Glossy copper | 1x max 46W E14 | Si Yes | Vedi tabella p. 181 See table p. 181 | 700,00 € |



CE ENEC Classe II IP20

BIS / TRIS
HISTORICAL ARCHIVE
1954







| Codice Code | Materiale Material | Colore Colour | Sorgente luminosa Light source | Dimmer incluso Dimmer included | Classe energetica Energy label | Prezzo Retail con IVA Retail Price VAT incl. |
|----------------|--------------------------------|--|--------------------------------|--------------------------------|---|--|
| F228005150TNNE | Vetro, Metallo Glass, Metal |  Ottone, Nero Brass, Black | 4x max 30W E14 | No | Vedi tabella p. 181 See table p. 181 | 1.210,00 € |
| F228005150CBNE | Vetro, Metallo Glass, Metal |  Cromo, Bianco Chrome, White | 4x max 30W E14 | No | Vedi tabella p. 181 See table p. 181 | 1.160,00 € |

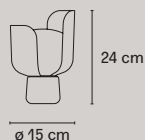

BLOM
ANDREAS ENGESVIK
2013



| Codice Code | Materiale Material | Colore Colour | Sorgente luminosa Light source | Dimmer incluso Dimmer included | Classe energetica Energy label | Prezzo Retail con IVA Retail Price VAT incl. |
|----------------|--|---|--------------------------------|--------------------------------|---|--|
| F425305350BINE | Polimero, Alluminio Polymer, Aluminum |  Bianco White | 1x max 11W E14 | No | Vedi tabella p. 181 See table p. 181 | 190,00 € |
| F425305350BLNE | Polimero, Alluminio Polymer, Aluminum |  Blu Blue | 1x max 11W E14 | No | Vedi tabella p. 181 See table p. 181 | 190,00 € |
| F425305350GSNE | Polimero, Alluminio Polymer, Aluminum |  Grigio Scuro Dark Gray | 1x max 11W E14 | No | Vedi tabella p. 181 See table p. 181 | 190,00 € |
| F425305350GINE | Polimero, Alluminio Polymer, Aluminum |  Giallo Yellow | 1x max 11W E14 | No | Vedi tabella p. 181 See table p. 181 | 190,00 € |
| F425305350VINE | Polimero, Alluminio Polymer, Aluminum |  Viola Violet | 1x max 11W E14 | No | Vedi tabella p. 181 See table p. 181 | 190,00 € |
| F425305350VENE | Polimero, Alluminio Polymer, Aluminum |  Verde Green | 1x max 11W E14 | No | Vedi tabella p. 181 See table p. 181 | 190,00 € |
| F425305350RSNE | Polimero, Alluminio Polymer, Aluminum |  Rosa Pink | 1x max 11W E14 | No | Vedi tabella p. 181 See table p. 181 | 190,00 € |



CHESHIRE
GAMFRATESI
2013



| Codice Code | Materiale Material | Colore Colour | Sorgente luminosa Light source | Dimmer incluso Dimmer included | Classe energetica Energy label | Prezzo Retail con IVA Retail Price VAT incl. |
|----------------|-------------------------------------|-------------------|--------------------------------|--------------------------------|---|--|
| F425105350BINE | Polimero, Metallo Polymer, Metal | ○ Bianco White | 3x max 23W E27 | No | Vedi tabella p. 181 See table p. 181 | 520,00 € |
| F425105350NENE | Polimero, Metallo Polymer, Metal | ● Nero Black | 3x max 23W E27 | No | Vedi tabella p. 181 See table p. 181 | 520,00 € |



DARUMA
SERGIO ASTI
1968

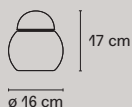

| Codice Code | Materiale Material | Colore Colour | Sorgente luminosa Light source | Dimmer incluso Dimmer included | Classe energetica Energy label | Prezzo Retail con IVA Retail Price VAT incl. |
|----------------|--------------------|-------------------|--------------------------------|--------------------------------|---|--|
| F502800100BINE | Vetro Glass | ○ Bianco White | 1x max 20W E27 | No | Vedi tabella p. 181 See table p. 181 | 325,00 € |

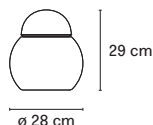

| Codice Code | Materiale Material | Colore Colour | Sorgente luminosa Light source | Dimmer incluso Dimmer included | Classe energetica Energy label | Prezzo Retail con IVA Retail Price VAT incl. |
|----------------|--------------------|-------------------|--------------------------------|--------------------------------|---|--|
| F502805100BINE | Vetro Glass | ○ Bianco White | 1x max 46W E27 | No | Vedi tabella p. 181 See table p. 181 | 500,00 € |

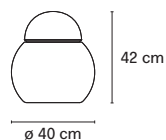

| Codice Code | Materiale Material | Colore Colour | Sorgente luminosa Light source | Dimmer incluso Dimmer included | Classe energetica Energy label | Prezzo Retail con IVA Retail Price VAT incl. |
|----------------|--------------------|-------------------|--------------------------------|--------------------------------|---|--|
| F502810100BINE | Vetro Glass | ○ Bianco White | 1x max 100W E27 | No | Vedi tabella p. 181 See table p. 181 | 860,00 € |



EQUATORE
GABRIELE E OSCAR BURATTI
2017

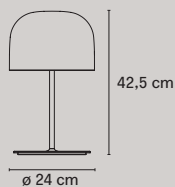

| Codice Code | Materiale Material | Colore Colour | Sorgente luminosa Light source | Dimmer incluso Dimmer included | Classe energetica Energy label | Prezzo Retail con IVA Retail Price VAT incl. |
|----------------|--|------------------------------|------------------------------------|--------------------------------|--------------------------------|--|
| F438900550CRWL | Vetro, Metallo Galvanizzato Glass, Galvanized Metal | Cromo Chrome | LED 25W (2700K, CRI>90, 2900Lm) | Si Yes | F | 1.420,00 € |
| F438900550NEWL | Vetro, Metallo Galvanizzato Glass, Galvanized Metal | Nero lucido Glossy black | LED 25W (2700K, CRI>90, 2900Lm) | Si Yes | F | 1.420,00 € |
| F438900150OOWL | Vetro, Metallo Glass, Metal | Oro opaco Matt gold | LED 25W (2700K, CRI>90, 2900Lm) | Si Yes | F | 1.250,00 € |
| F438900550RSWL | Vetro, Metallo Galvanizzato Glass, Galvanized Metal | Rame lucido Glossy copper | LED 25W (2700K, CRI>90, 2900Lm) | Si Yes | F | 1.420,00 € |



LED integrato
Integrated LED



Su richiesta tecnologia
Dali o Casambi
Dali or Casambi
technology on request

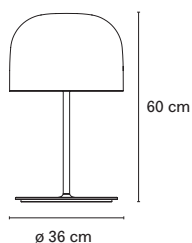

| Codice Code | Materiale Material | Colore Colour | Sorgente luminosa Light source | Dimmer incluso Dimmer included | Classe energetica Energy label | Prezzo Retail con IVA Retail Price VAT incl. |
|----------------|--|------------------------------|------------------------------------|--------------------------------|--------------------------------|--|
| F438905550CRWL | Vetro, Metallo Galvanizzato Glass, Galvanized Metal | Cromo Chrome | LED 40W (2700K, CRI>90, 4500Lm) | Si Yes | F | 2.050,00 € |
| F438905550NEWL | Vetro, Metallo Galvanizzato Glass, Galvanized Metal | Nero lucido Glossy black | LED 40W (2700K, CRI>90, 4500Lm) | Si Yes | F | 2.050,00 € |
| F438905150OOWL | Vetro, Metallo Glass, Metal | Oro opaco Matt gold | LED 40W (2700K, CRI>90, 4500Lm) | Si Yes | F | 1.860,00 € |
| F438905550RSWL | Vetro, Metallo Galvanizzato Glass, Galvanized Metal | Rame lucido Glossy copper | LED 40W (2700K, CRI>90, 4500Lm) | Si Yes | F | 2.050,00 € |



LED integrato
Integrated LED



Su richiesta tecnologia
Dali o Casambi
Dali or Casambi
technology on request

FALENA
ALVARO SIZA
1994

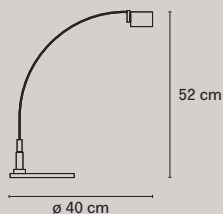

| Codice Code | Materiale Material | Colore Colour | Sorgente luminosa Light source | Dimmer incluso Dimmer included | Classe energetica Energy label | Prezzo Retail con IVA Retail Price VAT incl. |
|----------------|--------------------------------|-----------------|--------------------------------|--------------------------------|---|--|
| F301705150CRNE | Vetro, Metallo Glass, Metal | Cromo Chrome | 1x max 50W GY6.35 | No | Vedi tabella p. 181 See table p. 181 | 640,00 € |

CE ENEC Classe II IP20

FONTANA
MAX INGRAND
1954

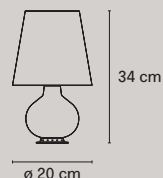

| Codice Code | Materiale Material | Colore Colour | Sorgente luminosa Light source | Dimmer incluso Dimmer included | Classe energetica Energy label | Prezzo Retail con IVA Retail Price VAT incl. |
|----------------|--------------------|-----------------|-----------------------------------|--------------------------------|---|--|
| F185300100BINE | Vetro Glass | Bianco White | 1x max 59W E27 + 2x max 19W G9 | No | Vedi tabella p. 181 See table p. 181 | 595,00 € |



Doppia accensione
Double light controls

CE ENEC Classe II IP20

| Codice Code | Materiale Material | Colore Colour | Sorgente luminosa Light source | Dimmer incluso Dimmer included | Classe energetica Energy label | Prezzo Retail con IVA Retail Price VAT incl. |
|----------------|--------------------|-----------------|--------------------------------|--------------------------------|---|--|
| F185300200OTNE | Metallo Metal | Ottone Brass | 1x max 100W E27 | Sì Yes | Vedi tabella p. 181 See table p. 181 | 1.050,00 € |

CE ENEC Classe II IP20

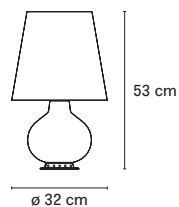

| Codice Code | Materiale Material | Colore Colour | Sorgente luminosa Light source | Dimmer incluso Dimmer included | Classe energetica Energy label | Prezzo Retail con IVA Retail Price VAT incl. |
|----------------|--------------------|-----------------|-------------------------------------|--------------------------------|---|--|
| F185305100BINE | Vetro Glass | Bianco White | 1x max 100W E27 + 2x max 30W E14 | No | Vedi tabella p. 181 See table p. 181 | 895,00 € |





Doppia accensione
Double light controls

CE ENEC Classe II IP20

| Codice Code | Materiale Material | Colore Colour | Sorgente luminosa Light source | Dimmer incluso Dimmer included | Classe energetica Energy label | Prezzo Retail con IVA Retail Price VAT incl. |
|----------------|--------------------|--|--------------------------------|--------------------------------|--------------------------------------|--|
| F185305200OTNE | Metallo Metal |  Ottone Brass | 1x max 100W E27 | Si, Yes | Vedi tabella p. 181 See table p. 181 | 1.460,00 € |

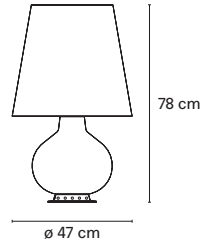
CE ENEC Classe II IP20



| Codice Code | Materiale Material | Colore Colour | Sorgente luminosa Light source | Dimmer incluso Dimmer included | Classe energetica Energy label | Prezzo Retail con IVA Retail Price VAT incl. |
|----------------|--------------------|--|---|--------------------------------|--------------------------------------|--|
| F185310100BINE | Vetro Glass |  Bianco White | 1x max 100W E27 + 4x max 46W E27 + 3x max 30W E14 | No | Vedi tabella p. 181 See table p. 181 | 1.650,00 € |







VETRO SOFFIATO
BLOWN GLASS

Tripla accensione
Triple light controls

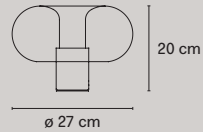
CE ENEC Classe II IP20

FONTANELLA FEDERICO PERI 2020







| Codice Code | Materiale Material | Colore Colour | Sorgente luminosa Light source | Dimmer incluso Dimmer included | Classe energetica Energy label | Prezzo Retail con IVA Retail Price VAT incl. |
|----------------|--|--|--------------------------------|--------------------------------|--------------------------------------|--|
| F442305550CRNE | Vetro, Metallo Galvanizzato Glass, Galvanized Metal |  Cromo Chrome | 1x max 28W E14 | Si Yes | Vedi tabella p. 181 See table p. 181 | 540,00 € |
| F442305550NENE | Vetro, Metallo Galvanizzato Glass, Galvanized Metal |  Nero lucido Glossy black | 1x max 28W E14 | Si Yes | Vedi tabella p. 181 See table p. 181 | 540,00 € |
| F442305550OTNE | Vetro, Metallo Galvanizzato Glass, Galvanized Metal |  Ottone lucido Glossy Brass | 1x max 28W E14 | Si Yes | Vedi tabella p. 181 See table p. 181 | 540,00 € |



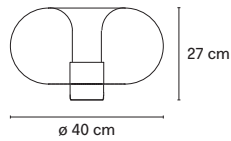

VETRO SOFFIATO
BLOWN GLASS

CE Classe II IP20





| Codice Code | Materiale Material | Colore Colour | Sorgente luminosa Light source | Dimmer incluso Dimmer included | Classe energetica Energy label | Prezzo Retail con IVA Retail Price VAT incl. |
|----------------|---|--|--------------------------------|--------------------------------|--------------------------------------|--|
| F442310550CRNE | Vetro, Metallo Galvanizzato Glass, Galvanized Metal |  Cromo Chrome | 1x max 77W E27 | Si Yes | Vedi tabella p. 181 See table p. 181 | 800,00 € |
| F442310550NENE | Vetro, Metallo Galvanizzato Glass, Galvanized Metal |  Nero lucido Glossy black | 1x max 77W E27 | Si Yes | Vedi tabella p. 181 See table p. 181 | 800,00 € |
| F442310550OTNE | Vetro, Metallo Galvanizzato Glass, Galvanized Metal |  Ottone lucido Glossy Brass | 1x max 77W E27 | Si Yes | Vedi tabella p. 181 See table p. 181 | 800,00 € |

 VETRO SOFFIATO BLOWN GLASS

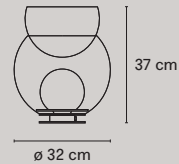

 Classe II  IP20

GIOVA GAE AULENTI 1964





| Codice Code | Materiale Material | Colore Colour | Sorgente luminosa Light source | Dimmer incluso Dimmer included | Classe energetica Energy label | Prezzo Retail con IVA Retail Price VAT incl. |
|----------------|--|--|--------------------------------|--------------------------------|--------------------------------------|--|
| F268405150CRNE | Vetro, Metallo Glass, Metal |  Cromo, Rosa Chrome, Pink | 1x max 46W E27 | No | Vedi tabella p. 181 See table p. 181 | 1.200,00 € |
| F268405575OONE | Vetro, Metallo Galvanizzato Glass, Metal |  Oro, Grigio Gold, Gray | 1x max 46W E27 | No | Vedi tabella p. 181 See table p. 181 | 1.380,00 € |

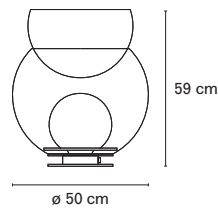

 VETRO SOFFIATO BLOWN GLASS

  Classe II  IP20





| Codice Code | Materiale Material | Colore Colour | Sorgente luminosa Light source | Dimmer incluso Dimmer included | Classe energetica Energy label | Prezzo Retail con IVA Retail Price VAT incl. |
|----------------|---|--|--------------------------------|--------------------------------|--------------------------------------|--|
| F268410150CRNE | Vetro, Metallo Glass, Metal |  Cromo, Rosa Chrome, Pink | 1x max 100W E27 | No | Vedi tabella p. 181 See table p. 181 | 1.750,00 € |
| F268410575OONE | Vetro, Metallo Galvanizzato Glass, Galvanized Metal |  Oro, Grigio Gold, Gray | 1x max 100W E27 | No | Vedi tabella p. 181 See table p. 181 | 1.930,00 € |

 VETRO SOFFIATO BLOWN GLASS

  Classe II  IP20

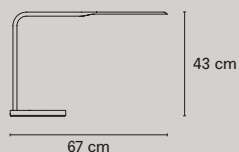

KINX
KARIM RASHID
2015



| Codice Code | Materiale Material | Colore Colour | Sorgente luminosa Light source | Dimmer incluso Dimmer included | Classe energetica Energy label | Prezzo Retail con IVA Retail Price VAT incl. |
|--|--------------------|---------------|---------------------------------|---|--------------------------------|--|
| F431205200NEWL | Metallo Metal | ● Nero Black | LED 7,5W (2700K, CRI>80, 940Lm) | Si, touch Yes, touch | F | 595,00 € |
| Base provvista di porta USB Base provided with USB port | | | LED integrato Integrated LED |  Classe III  | | |

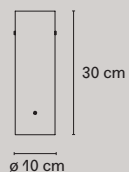

LASOSPESA
STEFANO BOERI
ARCHITETTI
2019

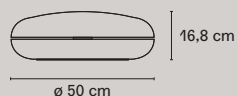

| Codice Code | Materiale Material | Colore Colour | Sorgente luminosa Light source | Dimmer incluso Dimmer included | Classe energetica Energy label | Prezzo Retail con IVA Retail Price VAT incl. |
|----------------|--------------------------------|------------------------------|---------------------------------|---|--------------------------------|--|
| F443105150TRWL | Vetro, Metallo Glass, Metal | ○ Trasparente Transparent | LED 6,5W (2700K, CRI>80, 700Lm) | Si Yes | F | 620,00 € |
| | | | LED integrato Integrated LED |  Classe III  | | |

LOOP
VOON WONG
& BENSON SAW
2003



| Codice Code | Materiale Material | Colore Colour | Sorgente luminosa Light source | Dimmer incluso Dimmer included | Classe energetica Energy label | Prezzo Retail con IVA Retail Price VAT incl. |
|----------------|--------------------|-----------------|-----------------------------------|--|--------------------------------|--|
| F542910200AXLE | Metallo Metal | ● Acciaio Steel | LED 28,6W (3000K, CRI>80, 3650Lm) | No | D | 1.590,00 € |
| | | | LED integrato Integrated LED |  Classe II  | | |

MANO
PIETRO CHIESA
1932

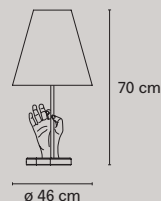

| Codice Code | Materiale Material | Colore Colour | Sorgente luminosa Light source | Dimmer incluso Dimmer included | Classe energetica Energy label | Prezzo Retail con IVA Retail Price VAT incl. |
|----------------|-----------------------------------|------------------|-----------------------------------|-----------------------------------|---|---|
| F420805400NENE | Metallo, Tessuto Metal, Fabric | Nero Black | 1x max 57W E27 | Si Yes | Vedi tabella p. 181 See table p. 181 | 650,00 € |



MATRIX
STUDIO OS Δ OOS
2020

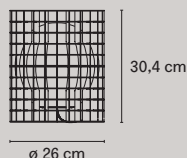

| Codice Code | Materiale Material | Colore Colour | Sorgente luminosa Light source | Dimmer incluso Dimmer included | Classe energetica Energy label | Prezzo Retail con IVA Retail Price VAT incl. |
|----------------|--------------------------------|----------------------------|-----------------------------------|-----------------------------------|-----------------------------------|---|
| F444305250BIWL | Vetro, Metallo Glass, Metal | Bianco White | LED 8W (2700K, CRI>90, 1180Lm) | Si Yes | F | 1.300,00 € |
| F444305250OBWL | Vetro, Metallo Glass, Metal | Oro, Bianco Gold, White | LED 8W (2700K, CRI>90, 1180Lm) | Si Yes | F | 1.500,00 € |



LED integrato
Integrated LED

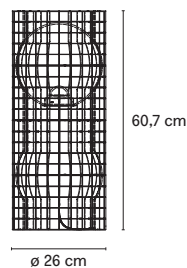

| Codice Code | Materiale Material | Colore Colour | Sorgente luminosa Light source | Dimmer incluso Dimmer included | Classe energetica Energy label | Prezzo Retail con IVA Retail Price VAT incl. |
|----------------|--------------------------------|----------------------------|-----------------------------------|-----------------------------------|-----------------------------------|---|
| F444310250BIWL | Vetro, Metallo Glass, Metal | Bianco White | LED 8W (2700K, CRI>90, 1180Lm) | Si Yes | F | 2.150,00 € |
| F444310250OBWL | Vetro, Metallo Glass, Metal | Oro, Bianco Gold, White | LED 8W (2700K, CRI>90, 1180Lm) | Si Yes | F | 2.400,00 € |



LED integrato
Integrated LED



MERIDIANO
GABRIELE E OSCAR BURATTI
2020

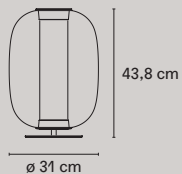

| Codice Code | Materiale Material | Colore Colour | Sorgente luminosa Light source | Dimmer incluso Dimmer included | Classe energetica Energy label | Prezzo Retail con IVA Retail Price VAT incl. |
|----------------|--|---|------------------------------------|--------------------------------|--------------------------------|--|
| F441705550NFWL | Vetro, Metallo Galvanizzato Glass, Galvanized Metal | ● Nero, Fumè Black, Grey fumè | LED 25W (2700K, CRI>90, 2900Lm) | Si Yes | F | 1.700,00 € |
| F441705550NRWL | Vetro, Metallo Galvanizzato Glass, Galvanized Metal | ● Nero, Rosa Black, Pink | LED 25W (2700K, CRI>90, 2900Lm) | Si Yes | F | 1.700,00 € |
| F441705550NTWL | Vetro, Metallo Galvanizzato Glass, Galvanized Metal | ● Nero, Trasparente Black, Transparent | LED 25W (2700K, CRI>90, 2900Lm) | Si Yes | F | 1.700,00 € |
| | | | LED integrato Integrated LED | Classe II IP20 | | |

METAFORA
UMBERTO RIVA
1980 Re-Edition

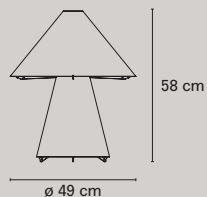

| Codice Code | Materiale Material | Colore Colour | Sorgente luminosa Light source | Dimmer incluso Dimmer included | Classe energetica Energy label | Prezzo Retail con IVA Retail Price VAT incl. |
|----------------|--------------------------------|---|--------------------------------|--------------------------------|---|--|
| F265405150BTNE | Vetro, Metallo Glass, Metal | ○ Bianco, Trasparente White, Transparent | 1x max 116W E27 | Si Yes | Vedi tabella p. 181 See table p. 181 | 1.080,00 € |
| | | | | Classe II IP20 | | |

NASKA
HISTORICAL ARCHIVE
1933

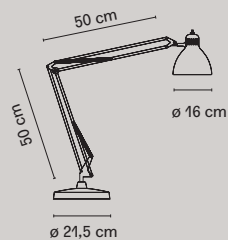

| Codice Code | Materiale Material | Colore Colour | Sorgente luminosa Light source | Dimmer incluso Dimmer included | Classe energetica Energy label | Prezzo Retail con IVA Retail Price VAT incl. |
|----------------|---------------------------------------|----------------|--------------------------------|--------------------------------|--------------------------------------|--|
| F810010200BINE | Metallo Verniciato Painted Metal | ○ Bianco White | 1x max 46W E27 | No | Vedi tabella p. 181 See table p. 181 | 545,00 € |
| F810010240CRNE | Metallo Galvanizzato Galvanized Metal | ◐ Cromo Chrome | 1x max 46W E27 | No | Vedi tabella p. 181 See table p. 181 | 630,00 € |
| F810010200NENE | Metallo Verniciato Painted Metal | ● Nero Black | 1x max 46W E27 | No | Vedi tabella p. 181 See table p. 181 | 545,00 € |

CE ENEC Classe III IP20

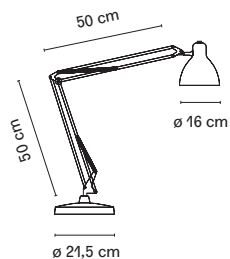

| Codice Code | Materiale Material | Colore Colour | Sorgente luminosa Light source | Dimmer incluso Dimmer included | Classe energetica Energy label | Prezzo Retail con IVA Retail Price VAT incl. |
|----------------|---------------------------------------|----------------|--------------------------------|--------------------------------|--------------------------------|--|
| F810010200BIWL | Metallo Verniciato Painted Metal | ○ Bianco White | LED 6W (2700K, CRI>80, 800Lm) | Si, touch Yes, touch | F | 570,00 € |
| F810010240CRWL | Metallo Galvanizzato Galvanized Metal | ◐ Cromo Chrome | LED 6W (2700K, CRI>80, 800Lm) | Si, touch Yes, touch | F | 670,00 € |
| F810010200NEWL | Metallo Verniciato Painted Metal | ● Nero Black | LED 6W (2700K, CRI>80, 800Lm) | Si, touch Yes, touch | F | 570,00 € |
| F810010240OOWL | Metallo Galvanizzato Galvanized Metal | ● Oro Gold | LED 6W (2700K, CRI>80, 800Lm) | Si, touch Yes, touch | F | 670,00 € |

LED integrato Integrated LED

CE ENEC Classe III IP20

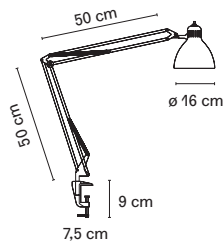

| Codice Code | Materiale Material | Colore Colour | Sorgente luminosa Light source | Dimmer incluso Dimmer included | Classe energetica Energy label | Prezzo Retail con IVA Retail Price VAT incl. |
|----------------|---------------------------------------|----------------|--------------------------------|--------------------------------|--------------------------------------|--|
| F810110200BINE | Metallo Verniciato Painted Metal | ○ Bianco White | 1x max 46W E27 | No | Vedi tabella p. 181 See table p. 181 | 440,00 € |
| F810010240CRNE | Metallo Galvanizzato Galvanized Metal | ◐ Cromo Chrome | 1x max 46W E27 | No | Vedi tabella p. 181 See table p. 181 | 540,00 € |
| F810110200NENE | Metallo Verniciato Painted Metal | ● Nero Black | 1x max 46W E27 | No | Vedi tabella p. 181 See table p. 181 | 440,00 € |

CE ENEC Classe II IP20

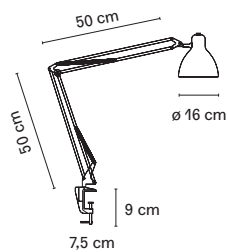

| Codice Code | Materiale Material | Colore Colour | Sorgente luminosa Light source | Dimmer incluso Dimmer included | Classe energetica Energy label | Prezzo Retail con IVA Retail Price VAT incl. |
|----------------|---------------------------------------|-------------------------|--------------------------------|--------------------------------|--------------------------------|--|
| F810110200BIWL | Metallo Verniciato Painted Metal | ○ Bianco White | LED 6W (2700K, CRI>80, 800Lm) | Si, touch Yes, touch | F | 470,00 € |
| F810110240CRWL | Metallo Galvanizzato Galvanized Metal | ◐ Cromo Chrome | LED 6W (2700K, CRI>80, 800Lm) | Si, touch Yes, touch | F | 570,00 € |
| F810110200NEWL | Metallo Verniciato Painted Metal | ● Nero Black | LED 6W (2700K, CRI>80, 800Lm) | Si, touch Yes, touch | F | 470,00 € |
| F810110240OOWL | Metallo Galvanizzato Galvanized Metal | ◐ Oro, Nero Gold, Black | LED 6W (2700K, CRI>80, 800Lm) | Si, touch Yes, touch | F | 570,00 € |

LED integrato Integrated LED

CE ENEC Classe II IP20

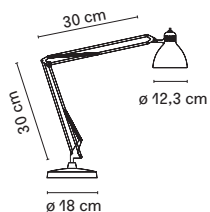

| Codice Code | Materiale Material | Colore Colour | Sorgente luminosa Light source | Dimmer incluso Dimmer included | Classe energetica Energy label | Prezzo Retail con IVA Retail Price VAT incl. |
|----------------|---------------------------------------|----------------|--------------------------------|--------------------------------|--------------------------------------|--|
| F810700200BINE | Metallo Verniciato Painted Metal | ○ Bianco White | 1x max 30W E27 | No | Vedi tabella p. 181 See table p. 181 | 485,00 € |
| F810700240CRNE | Metallo Galvanizzato Galvanized Metal | ◐ Cromo Chrome | 1x max 30W E27 | No | Vedi tabella p. 181 See table p. 181 | 580,00 € |
| F810700200NENE | Metallo Verniciato Painted Metal | ● Nero Black | 1x max 30W E27 | No | Vedi tabella p. 181 See table p. 181 | 485,00 € |

CE ENEC Classe II IP20

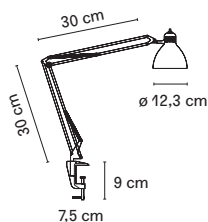

| Codice Code | Materiale Material | Colore Colour | Sorgente luminosa Light source | Dimmer incluso Dimmer included | Classe energetica Energy label | Prezzo Retail con IVA Retail Price VAT incl. |
|----------------|---------------------------------------|----------------|--------------------------------|--------------------------------|--------------------------------------|--|
| F810100200BINE | Metallo Verniciato Painted Metal | ○ Bianco White | 1x max 30W E27 | No | Vedi tabella p. 181 See table p. 181 | 430,00 € |
| F810100240CRNE | Metallo Galvanizzato Galvanized Metal | ◐ Cromo Chrome | 1x max 30W E27 | No | Vedi tabella p. 181 See table p. 181 | 495,00 € |
| F810100200NENE | Metallo Verniciato Painted Metal | ● Nero Black | 1x max 30W E27 | No | Vedi tabella p. 181 See table p. 181 | 430,00 € |

CE ENEC Classe II IP20

OORT SISTEMA
JACOPO RODA
2022

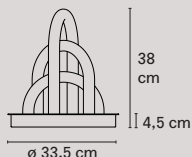

| Codice Code | Materiale Material | Colore Colour | Sorgente luminosa Light source | Dimmer incluso Dimmer included | Classe energetica Energy label | Prezzo Retail con IVA Retail Price VAT incl. |
|-------------|--------------------------------|-----------------------------------|--|----------------------------------|--------------------------------|--|
| OORT00020 | Vetro, Metallo Glass, Metal | Bianco, Specchio White, Mirror | LED 8W + 12W + 16W (3000K, 3400Lm) | Si, Yes | G | 1.240,00 € |
| OORT00021 | Vetro, Metallo Glass, Metal | Bianco, Specchio White, Mirror | LED 8W + 12W + 16W (DTW da 1800K a 4000K) | Si, Yes | G | 1.330,00 € |
| | | | LED integrato Integrated LED | <small>Classe II</small> IP20 | | |
| | | | Su richiesta 2700K 2700K on request | | | |

PALLINA
FONTANAARTE DESIGN LAB
2019

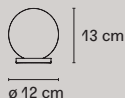

| Codice Code | Materiale Material | Colore Colour | Sorgente luminosa Light source | Dimmer incluso Dimmer included | Classe energetica Energy label | Prezzo Retail con IVA Retail Price VAT incl. |
|-------------------------------|--|--------------------------------|--------------------------------|--------------------------------|---|--|
| F443000150NENE | Vetro, Metallo Galvanizzato Glass, Galvanized Metal | Nero lucido Glossy black | 1x max 6W G9 | No | Vedi tabella p. 181 See table p. 181 | 210,00 € |
| F443000150NSNE | Vetro, Metallo Galvanizzato Glass, Galvanized Metal | Nichel lucido Glossy nickel | 1x max 6W G9 | No | Vedi tabella p. 181 See table p. 181 | 210,00 € |
| F443000150OTNE | Vetro, Metallo Galvanizzato Glass, Galvanized Metal | Ottone lucido Glossy brass | 1x max 6W G9 | No | Vedi tabella p. 181 See table p. 181 | 210,00 € |
| F443000150ORNE | Vetro, Metallo Verniciato Glass, Painted Metal | Oro rosa Rose gold | 1x max 6W G9 | No | Vedi tabella p. 181 See table p. 181 | 220,00 € |
| VETRO SOFFIATO BLOWN GLASS | | | | | <small>Classe II</small> IP20 | |

PAROLA
GAE AULENTI
E PIERO CASTIGLIONI
1980

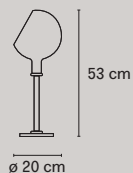

| Codice Code | Materiale Material | Colore Colour | Sorgente luminosa Light source | Dimmer incluso Dimmer included | Classe energetica Energy label | Prezzo Retail con IVA Retail Price VAT incl. |
|-------------------------------|--------------------|-----------------|--------------------------------|--------------------------------|---|--|
| F265805100AMNE | Vetro Glass | Ambra Amber | 1x max 46W E14 | Si Yes | Vedi tabella p. 181 See table p. 181 | 910,00 € |
| F265805100BINE | Vetro Glass | Bianco White | 1x max 46W E14 | Si Yes | Vedi tabella p. 181 See table p. 181 | 910,00 € |
| VETRO SOFFIATO BLOWN GLASS | | | | | <small>Classe II</small> IP20 | |

PASSION
STUDIO BERETTA
ASSOCIATI
2004



| Codice Code | Materiale Material | Colore Colour | Sorgente luminosa Light source | Dimmer incluso Dimmer included | Classe energetica Energy label | Prezzo Retail con IVA Retail Price VAT incl. |
|----------------|-----------------------------|---------------------------------|--------------------------------|--------------------------------|---|--|
| F361000150CRNE | Vetro, Metallo Glass, Metal | Cromo, Bianco Chrome, White | 1x max 48W G9 | Si Yes | Vedi tabella p. 181 See table p. 181 | 620,00 € |
| F361000150NCNE | Vetro, Metallo Glass, Metal | Nichel, Bianco Nickel, White | 1x max 48W G9 | Si Yes | Vedi tabella p. 181 See table p. 181 | 620,00 € |

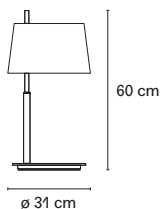

| Codice Code | Materiale Material | Colore Colour | Sorgente luminosa Light source | Dimmer incluso Dimmer included | Classe energetica Energy label | Prezzo Retail con IVA Retail Price VAT incl. |
|----------------|-----------------------------|---------------------------------|--------------------------------|--------------------------------|---|--|
| F361005150CRNE | Vetro, Metallo Glass, Metal | Cromo, Bianco Chrome, White | 1x max 116W E27 | Si Yes | Vedi tabella p. 181 See table p. 181 | 990,00 € |
| F361005150NCNE | Vetro, Metallo Glass, Metal | Nichel, Bianco Nickel, White | 1x max 116W E27 | Si Yes | Vedi tabella p. 181 See table p. 181 | 990,00 € |





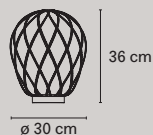

PINECONE
PAOLA NAVONE
2016



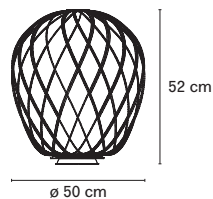

| Codice Code | Materiale Material | Colore Colour | Sorgente luminosa Light source | Dimmer incluso Dimmer included | Classe energetica Energy label | Prezzo Retail con IVA Retail Price VAT incl. |
|----------------|---|---|--------------------------------|--------------------------------|---|--|
| F436405550TCNE | Vetro, Metallo Galvanizzato Glass, Galvanized Metal | Trasparente, Cromo Transparent, Chrome | 1x max 116W E27 | Si Yes | Vedi tabella p. 181 See table p. 181 | 1.750,00 € |
| F436405550CBNE | Vetro, Metallo Galvanizzato Glass, Galvanized Metal | Bianco, Cromo White, Chrome | 1x max 116W E27 | Si Yes | Vedi tabella p. 181 See table p. 181 | 1.750,00 € |
| F436405575TONE | Vetro, Metallo Galvanizzato Glass, Galvanized Metal | Trasparente, Oro Transparent, Gold | 1x max 116W E27 | Si Yes | Vedi tabella p. 181 See table p. 181 | 1.850,00 € |
| F436405575OBNE | Vetro, Metallo Galvanizzato Glass, Galvanized Metal | Bianco, Oro White, Gold | 1x max 116W E27 | Si Yes | Vedi tabella p. 181 See table p. 181 | 1.850,00 € |







| Codice Code | Materiale Material | Colore Colour | Sorgente luminosa Light source | Dimmer incluso Dimmer included | Classe energetica Energy label | Prezzo Retail con IVA Retail Price VAT incl. |
|----------------|---|---|--------------------------------|--------------------------------|---|--|
| F434010550TCNE | Vetro, Metallo Galvanizzato Glass, Galvanized Metal |  Trasparente, Cromo Transparent, Chrome | 1x max 116W E27 | Si Yes | Vedi tabella p. 181 See table p. 181 | 2.150,00 € |
| F434010550CBNE | Vetro, Metallo Galvanizzato Glass, Galvanized Metal |  Bianco, Cromo White, Chrome | 1x max 116W E27 | Si Yes | Vedi tabella p. 181 See table p. 181 | 2.150,00 € |
| F434010575TONE | Vetro, Metallo Galvanizzato Glass, Galvanized Metal |  Trasparente, Oro Transparent, Gold | 1x max 116W E27 | Si Yes | Vedi tabella p. 181 See table p. 181 | 2.540,00 € |
| F434010575OBNE | Vetro, Metallo Galvanizzato Glass, Galvanized Metal |  Bianco, Oro White, Gold | 1x max 116W E27 | Si Yes | Vedi tabella p. 181 See table p. 181 | 2.540,00 € |

 VETRO SOFFIATO
BLOWN GLASS

 CE ENEC Intertek Classe II IP20

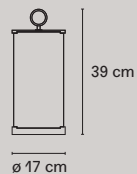
PIRELLINA GIO PONTI 1967





| Codice Code | Materiale Material | Colore Colour | Sorgente luminosa Light source | Dimmer incluso Dimmer included | Classe energetica Energy label | Prezzo Retail con IVA Retail Price VAT incl. |
|----------------|-----------------------------|---|--------------------------------|--------------------------------|---|--|
| F278205150KBNE | Vetro, Metallo Glass, Metal |  Nichel, Bianco Nickel, White | 4x max 20W E14 | Si Yes | Vedi tabella p. 181 See table p. 181 | 510,00 € |

 CE ENEC Classe II IP20

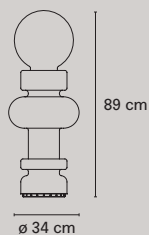
RE BOBO PICCOLI 1968 Re-Edition



| Codice Code | Materiale Material | Colore Colour | Sorgente luminosa Light source | Dimmer incluso Dimmer included | Classe energetica Energy label | Prezzo Retail con IVA Retail Price VAT incl. |
|----------------|--------------------|---|------------------------------------|--------------------------------|--------------------------------|--|
| F443810100BIWL | Vetro Glass |  Bianco White | LED 48W (3000K, CRI>85, 4800Lm) | Si Yes | F | 2.350,00 € |



 VETRO SOFFIATO
BLOWN GLASS

 CE ENEC Classe II IP20

LED integrato
Integrated LED

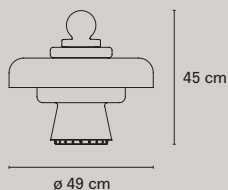

REGINA
BOBO PICCOLI
1968 Re-Edition



| Codice Code | Materiale Material | Colore Colour | Sorgente luminosa Light source | Dimmer incluso Dimmer included | Classe energetica Energy label | Prezzo Retail con IVA Retail Price VAT incl. |
|---|--------------------|----------------|---------------------------------|---|--------------------------------|--|
| F443710100BIWL | Vetro Glass | ○ Bianco White | LED 54W (3000K, CRI>85, 5500Lm) | Si Yes | F | 2.150,00 € |
|  | | | LED integrato Integrated LED |  Classe III  | | |

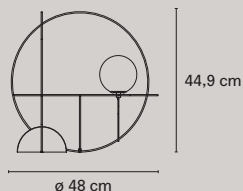

SETAREH
FRANCESCO LIBRIZZI
2017



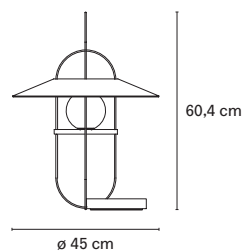

| Codice Code | Materiale Material | Colore Colour | Sorgente luminosa Light source | Dimmer incluso Dimmer included | Classe energetica Energy label | Prezzo Retail con IVA Retail Price VAT incl. |
|---|--|---|--------------------------------|---|--------------------------------|--|
| F440105500NBWL | Vetro, Metallo Galvanizzato, Marmo Glass, Galvanized Metal, Marble | ● Nero lucido, Bianco Glossy black, White | LED 6W (2700K, CRI>80, 830Lm) | Si Yes | E | 1.100,00 € |
| F440105500OBWL | Vetro, Metallo Galvanizzato, Marmo Glass, Galvanized Metal, Marble | ● Oro lucido, Bianco Glossy gold, White | LED 6W (2700K, CRI>80, 830Lm) | Si Yes | E | 1.100,00 € |
|  <p>Base in marmo bianco di Carrara per la versione oro e in grigio Carrara per la versione nero Base made in white Carrara marble for the gold version and in gray Carrara marble for black version</p> | | | LED integrato Integrated LED |  Classe III  | | |



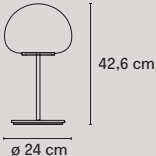

| Codice Code | Materiale Material | Colore Colour | Sorgente luminosa Light source | Dimmer incluso Dimmer included | Classe energetica Energy label | Prezzo Retail con IVA Retail Price VAT incl. |
|----------------|--|---|--------------------------------|--------------------------------|--------------------------------|--|
| F438405500NBWL | Vetro, Metallo Galvanizzato, Marmo Glass, Galvanized Metal, Marble | ● Nero lucido, Bianco Glossy black, White | LED 6W (2700K, CRI>80, 830Lm) | Si Yes | E | 1.250,00 € |

| | | | | | | |
|---|---|---|---|-----------|---|------------|
| F438405500BWL | Vetro, Metallo Galvanizzato, Marmo Glass, Galvanized Metal, Marble |  Oro lucido, Bianco Glossy gold, White | LED 6W (2700K, CRI>80, 830Lm) | Si Yes | E | 1.250,00 € |
|  <p>Base in marmo bianco di Carrara per la versione oro e in grigio Carnico per la versione nero Base made in white Carrara marble for the gold version and in gray Carnico marble for black version</p> | | LED integrato Integrated LED |  | | | |

THEA
GABRIELE E OSCAR BURATTI
2022

| Codice Code | Materiale Material | Colore Colour | Sorgente luminosa Light source | Dimmer incluso Dimmer included | Classe energetica Energy label | Prezzo Retail con IVA Retail Price VAT incl. |
|----------------|--|--|-------------------------------------|-----------------------------------|-----------------------------------|---|
| F444905550NFWL | Vetro, Metallo Galvanizzato Glass, Galvanized Metal |  Nero lucido, Fumè Glossy black, Grey fumè | LED 3,85W (3000K, CRI>90, 640Lm) | Si Yes | F | 1.090,00 € |
| F444905575RTWL | Vetro, Metallo Galvanizzato Glass, Galvanized Metal |  Rame lucido, Trasparente Glossy copper, Transparent | LED 3,85W (3000K, CRI>90, 640Lm) | Si Yes | F | 1.090,00 € |





LED integrato
Integrated LED

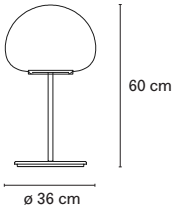

Su richiesta con
tecnologia Casambi
Casambi technology on
request



| Codice Code | Materiale Material | Colore Colour | Sorgente luminosa Light source | Dimmer incluso Dimmer included | Classe energetica Energy label | Prezzo Retail con IVA Retail Price VAT incl. |
|----------------|--|--|--------------------------------------|-----------------------------------|-----------------------------------|---|
| F444910550NFWL | Vetro, Metallo Galvanizzato Glass, Galvanized Metal |  Nero lucido, Fumè Glossy black, Grey fumè | LED 11,6W (3000K, CRI>90, 1596Lm) | Si Yes | F | 1.590,00 € |
| F444910575RTWL | Vetro, Metallo Galvanizzato Glass, Galvanized Metal |  Rame lucido, Trasparente Glossy copper, Transparent | LED 11,6W (3000K, CRI>90, 1596Lm) | Si Yes | F | 1.590,00 € |



LED integrato
Integrated LED



Su richiesta con
tecnologia Casambi
Casambi technology on
request

THOR
PAGANI PERVERSI
ARCHITECTS
2000



| Codice Code | Materiale Material | Colore Colour | Sorgente luminosa Light source | Dimmer incluso Dimmer included | Classe energetica Energy label | Prezzo Retail con IVA Retail Price VAT incl. |
|----------------|--------------------|----------------|--------------------------------|--------------------------------|--------------------------------------|--|
| F329500100BINE | Vetro Glass | ○ Bianco White | 1x max 30W E14 | No | Vedi tabella p. 181 See table p. 181 | 390,00 € |

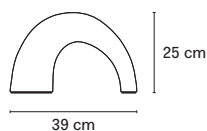

| Codice Code | Materiale Material | Colore Colour | Sorgente luminosa Light source | Dimmer incluso Dimmer included | Classe energetica Energy label | Prezzo Retail con IVA Retail Price VAT incl. |
|----------------|--------------------|----------------|--------------------------------|--------------------------------|--------------------------------------|--|
| F329505100BINE | Vetro Glass | ○ Bianco White | 1x max 46W E27 | No | Vedi tabella p. 181 See table p. 181 | 505,00 € |



TROPICO
GABRIELE E OSCAR BURATTI
2020

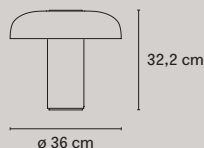

| Codice Code | Materiale Material | Colore Colour | Sorgente luminosa Light source | Dimmer incluso Dimmer included | Classe energetica Energy label | Prezzo Retail con IVA Retail Price VAT incl. |
|----------------|--|--|---------------------------------|--------------------------------|--------------------------------|--|
| F442105585BIWL | Vetro, Metallo Galvanizzato, Marmo Glass, Galvanized Metal, Marble | ● Bianco, Oro lucido White, Glossy gold | LED 32W (3000K, CRI>80, 3700Lm) | Si Yes | F | 1.180,00 € |
| F442105585GCWL | Vetro, Metallo Galvanizzato, Marmo Glass, Galvanized Metal, Marble | ● Grigio, Nero lucido Gray, Glossy black | LED 32W (3000K, CRI>80, 3700Lm) | Si Yes | F | 1.180,00 € |
| F442105585NEWL | Vetro, Metallo Galvanizzato, Marmo Glass, Galvanized Metal, Marble | ● Nero, Nero lucido Black, Glossy black | LED 32W (3000K, CRI>80, 3700Lm) | Si Yes | F | 1.180,00 € |



LED integrato
Integrated LED



Base in marmo bianco di Carrara con bottone oro, base in marmo grigio Bardiglio e nero Marquina con bottone nero
White Carrara marble base with polished gold button, Bardiglio grey and Marquina black marble base with polished black button

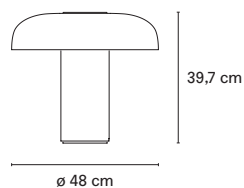

| Codice Code | Materiale Material | Colore Colour | Sorgente luminosa Light source | Dimmer incluso Dimmer included | Classe energetica Energy label | Prezzo Retail con IVA Retail Price VAT incl. |
|--|---|---|------------------------------------|--------------------------------|--------------------------------|--|
| F442110585BIWL | Vetro, Metallo Galvanizzato, Marmo Glass, Galvanized Metal, Marble | Bianco, Oro lucido White, Glossy gold | LED 42W (3000K, CRI>80, 4780Lm) | Si Yes | F | 1.800,00 € |
| F442110585GCWL | Vetro, Metallo Galvanizzato, Marmo Glass, Galvanized Metal, Marble | Grigio, Nero lucido Gray, Glossy black | LED 42W (3000K, CRI>80, 4780Lm) | Si Yes | F | 1.800,00 € |
| F442110585NEWL | Vetro, Metallo Galvanizzato, Marmo Glass, Galvanized Metal, Marble | Nero, Nero lucido Black, Glossy black | LED 42W (3000K, CRI>80, 4780Lm) | Si Yes | F | 1.800,00 € |
| VETRO SOFFIATO BLOWN GLASS Base in marmo bianco di Carrara con bottone oro, base in marmo grigio Bardiglio e nero Marquinia con bottone nero White Carrara marble base with polished gold button, Bardiglio grey and Marquinia black marble base with polished black button | | | LED integrato Integrated LED | IP20 | | |

UOVO BEN SWILDENS 1972

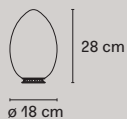

| Codice Code | Materiale Material | Colore Colour | Sorgente luminosa Light source | Dimmer incluso Dimmer included | Classe energetica Energy label | Prezzo Retail con IVA Retail Price VAT incl. |
|-------------------------------|--------------------|-----------------|--------------------------------|--------------------------------|---|--|
| F264600100BINE | Vetro Glass | Bianco White | 1x max 30W E27 | Si Yes | Vedi tabella p. 181 See table p. 181 | 325,00 € |
| VETRO SOFFIATO BLOWN GLASS | | | | IP20 | | |
| | | | | | | |
| Codice Code | Materiale Material | Colore Colour | Sorgente luminosa Light source | Dimmer incluso Dimmer included | Classe energetica Energy label | Prezzo Retail con IVA Retail Price VAT incl. |
| F264605100BINE | Vetro Glass | Bianco White | 1x max 70W E27 | Si Yes | Vedi tabella p. 181 See table p. 181 | 420,00 € |
| VETRO SOFFIATO BLOWN GLASS | | | | IP20 | | |

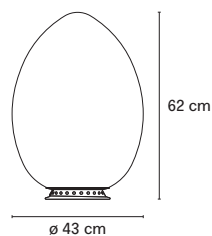

| Codice Code | Materiale Material | Colore Colour | Sorgente luminosa Light source | Dimmer incluso Dimmer included | Classe energetica Energy label | Prezzo Retail con IVA Retail Price VAT incl. |
|----------------|--------------------|----------------|--------------------------------|--------------------------------|--------------------------------------|--|
| F264610100BINE | Vetro Glass | ○ Bianco White | 1x max 100W E27 | Si Yes | Vedi tabella p. 181 See table p. 181 | 720,00 € |





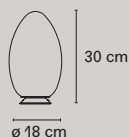

UOVO RICARICABILE / RECHARGEABLE BEN SWILDENS 1972



| Codice Code | Materiale Material | Colore Colour | Sorgente luminosa Light source | Dimmer incluso Dimmer included | Classe energetica Energy label | Prezzo Retail con IVA Retail Price VAT incl. |
|----------------|-----------------------------|----------------|--------------------------------|--------------------------------|--------------------------------|--|
| F264600150BIBW | Vetro, Metallo Glass, Metal | ○ Bianco White | LED 2,2W (250Lm) | Si Yes | F | 395,00 € |







LED integrato
 Integrated LED

durata 8 ore alla massima
 potenza
 8 hours duration at
 maximum power

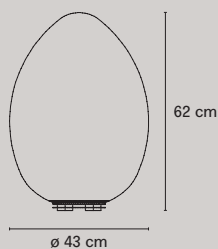
UOVO INDOOR / OUTDOOR BEN SWILDENS 1972



| Codice Code | Materiale Material | Colore Colour | Sorgente luminosa Light source | Dimmer incluso Dimmer included | Classe energetica Energy label | Prezzo Retail con IVA Retail Price VAT incl. |
|----------------|----------------------------------|----------------|--------------------------------|--------------------------------|--------------------------------------|--|
| F264613370BINE | Polimero, Metallo Polymer, Metal | ○ Bianco White | 1x max 30W E27 | No | Vedi tabella p. 181 See table p. 181 | 825,00 € |



VOLÉE
ODO FIORAVANTI
2015

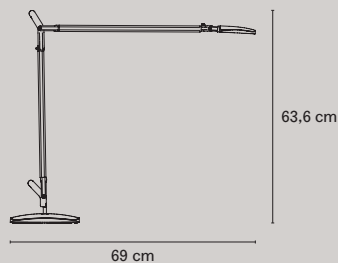

| Codice Code | Materiale Material | Colore Colour | Sorgente luminosa Light source | Dimmer incluso Dimmer included | Classe Energetica Energy label | Prezzo Retail con IVA Retail Price VAT incl. |
|---------------------------------|-------------------------------------|-----------------------------|------------------------------------|-----------------------------------|-----------------------------------|---|
| F429005350BIWL | Polimero, Metallo Polymer, Metal | ○ Bianco White | LED 7,5W (2700K, CRI>90, 800Lm) | Si, touch Yes, touch | F | 450,00 € |
| F429005350GIWL | Polimero, Metallo Polymer, Metal | ● Giallo Yellow | LED 7,5W (2700K, CRI>90, 800Lm) | Si, touch Yes, touch | F | 450,00 € |
| F429005350GSWL | Polimero, Metallo Polymer, Metal | ● Grigio scuro Dark gray | LED 7,5W (2700K, CRI>90, 800Lm) | Si, touch Yes, touch | F | 450,00 € |
| LED integrato Integrated LED | | | | | | |

DEMI VOLÉE
ODO FIORAVANTI
2015

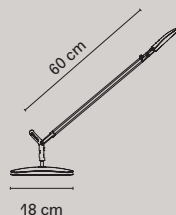

| Codice Code | Materiale Material | Colore Colour | Sorgente luminosa Light source | Dimmer incluso Dimmer included | Classe energetica Energy label | Prezzo Retail con IVA Retail Price VAT incl. |
|---------------------------------|-------------------------------------|-----------------------------|------------------------------------|-----------------------------------|-----------------------------------|---|
| F429000350BIWL | Polimero, Metallo Polymer, Metal | ○ Bianco White | LED 7,5W (2700K, CRI>90, 800Lm) | Si, touch Yes, touch | F | 370,00 € |
| F429000350GIWL | Polimero, Metallo Polymer, Metal | ● Giallo Yellow | LED 7,5W (2700K, CRI>90, 800Lm) | Si, touch Yes, touch | F | 370,00 € |
| F429000350GSWL | Polimero, Metallo Polymer, Metal | ● Grigio scuro Dark gray | LED 7,5W (2700K, CRI>90, 800Lm) | Si, touch Yes, touch | F | 370,00 € |
| LED integrato Integrated LED | | | | | | |

LAMPADE DA TERRA / FLOOR LAMPS

| | | | |
|---------------|-------|---------|-------|
| 0024 | p. 51 | THEA | p. 63 |
| 3247 | p. 51 | TRIPOD | p. 63 |
| ALICANTO | p. 52 | VERTIGO | p. 64 |
| BIANCA | p. 53 | YUMI | p. 64 |
| CHESHIRE | p. 53 | | |
| EQUATORE | p. 54 | | |
| FALENA | p. 55 | | |
| FLÛTE | p. 55 | | |
| GALERIE | p. 56 | | |
| LUMEN | p. 57 | | |
| LUMINATOR | p. 57 | | |
| MERIDIANO | p. 58 | | |
| NASKA XL | p. 58 | | |
| OORT SISTEMA | p. 59 | | |
| PAROLA | p. 60 | | |
| PAROLONA | p. 60 | | |
| PIRELLONE | p. 61 | | |
| PRIMA SIGNORA | p. 61 | | |
| RILUMINATOR | p. 62 | | |
| SCINTILLA | p. 62 | | |

0024
GIO PONTI
1933



| Codice Code | Materiale Material | Colore Colour | Sorgente luminosa Light source | Dimmer incluso Dimmer included | Classe energetica Energy label | Prezzo Retail con IVA Retail Price VAT incl. |
|----------------|--------------------------------|---|-----------------------------------|-----------------------------------|---|---|
| F002430150TRNE | Vetro, Metallo Glass, Metal |  Trasparente, Cromo Transparent, Chrome | 1x max 205W E27 | Si Yes | Vedi tabella p. 181 See table p. 181 | 2.400,00 € |

CE ENEC IP20

3247
HISTORICAL ARCHIVE
1954

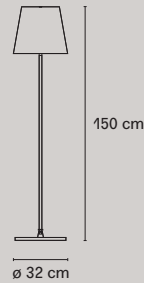



| Codice Code | Materiale Material | Colore Colour | Sorgente luminosa Light source | Dimmer incluso Dimmer included | Classe energetica Energy label | Prezzo Retail con IVA Retail Price VAT incl. |
|----------------|--------------------------------|---|-----------------------------------|-----------------------------------|---|---|
| F324725150KBNE | Vetro, Metallo Glass, Metal |  Nichel, Bianco Nickel, White | 1x max 150W E27 | Si Yes | Vedi tabella p. 181 See table p. 181 | 930,00 € |



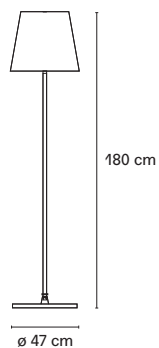

CE ENEC Classe # IP20

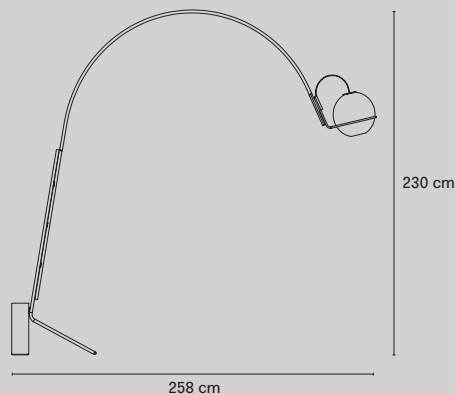

| Codice Code | Materiale Material | Colore Colour | Sorgente luminosa Light source | Dimmer incluso Dimmer included | Classe energetica Energy label | Prezzo Retail con IVA Retail Price VAT incl. |
|---|--------------------------------|---------------------------------|--|---|---|--|
| F324730150KBNE | Vetro, Metallo Glass, Metal | Nichel, Bianco Nickel, White | 4x max 46W E27* + 1x max 100W E27** | *Sì Yes **No | Vedi tabella p. 181 See table p. 181 | 1.800,00 € |
|  | | | Doppia accensione Double light controls |  | | |

ALICANTO
FRANCESCO LIBRIZZI
2021



| Codice Code | Materiale Material | Colore Colour | Sorgente luminosa Light source | Dimmer incluso Dimmer included | Classe energetica Energy label | Prezzo Retail con IVA Retail Price VAT incl. |
|---|---|----------------------------|--|---|--------------------------------|--|
| F443630160OBWL | Vetro, Metallo Verniciato Glass, Painted Metal | Oro, Bianco Gold, White | LED 17W (3000K, CRI>90, 2430Lm) | Sì Yes | E | 3.300,00 € |
| F443630160ONWL | Vetro, Metallo Verniciato Glass, Painted Metal | Oro, Nero Gold, Black | LED 17W (3000K, CRI>90, 2430Lm) | Sì Yes | E | 3.300,00 € |
|  | | | LED integrato Integrated LED |  | | |
| | | | Su richiesta tecnologia Casambi e 2700K Casambi technology and 2700K on request | | | |

BIANCA
MATTI KLENELL
2015



177,5 cm

ø 50 cm



| Codice Code | Materiale Material | Colore Colour | Sorgente luminosa Light source | Dimmer incluso Dimmer included | Classe energetica Energy label | Prezzo Retail con IVA Retail Price VAT incl. |
|----------------|--------------------------------|-------------------|-----------------------------------|-----------------------------------|---|---|
| F430930150BINE | Vetro, Metallo Glass, Metal | ○ Bianco White | 1x max 116W E27 | Si Yes | Vedi tabella p. 181 See table p. 181 | 1.100,00 € |



CE ENEC Classe II IP20

CHESHIRE
GAMFRATESI
2013



145 cm

ø 35 cm







| Codice Code | Materiale Material | Colore Colour | Sorgente luminosa Light source | Dimmer incluso Dimmer included | Classe energetica Energy label | Prezzo Retail con IVA Retail Price VAT incl. |
|----------------|-------------------------------------|-------------------|-----------------------------------|-----------------------------------|---|---|
| F425225350BINE | Polimero, Metallo Polymer, Metal | ○ Bianco White | 3x max 23W E27 | No | Vedi tabella p. 181 See table p. 181 | 630,00 € |
| F425225350NENE | Polimero, Metallo Polymer, Metal | ● Nero Black | 3x max 23W E27 | No | Vedi tabella p. 181 See table p. 181 | 630,00 € |

CE ENEC IP40 Intertek

EQUATORE
GABRIELE E OSCAR BURATTI
2017



| Codice Code | Materiale Material | Colore Colour | Sorgente luminosa Light source | Dimmer incluso Dimmer included | Classe energetica Energy label | Prezzo Retail con IVA Retail Price VAT incl. |
|----------------|---|---|---------------------------------|--------------------------------|--------------------------------|--|
| F439220550CRWL | Vetro, Metallo Galvanizzato Glass, Galvanized Metal |  Cromo Chrome | LED 25W (2700K, CRI>90, 2900Lm) | Si Yes | F | 1.540,00 € |
| F439220550NEWL | Vetro, Metallo Galvanizzato Glass, Galvanized Metal |  Nero lucido Glossy black | LED 25W (2700K, CRI>90, 2900Lm) | Si Yes | F | 1.540,00 € |
| F439220150OOWL | Vetro, Metallo Glass, Metal |  Oro opaco Matt gold | LED 25W (2700K, CRI>90, 2900Lm) | Si Yes | F | 1.380,00 € |
| F439220550RSWL | Vetro, Metallo Galvanizzato Glass, Galvanized Metal |  Rame lucido Glossy copper | LED 25W (2700K, CRI>90, 2900Lm) | Si Yes | F | 1.540,00 € |







LED integrato
Integrated LED

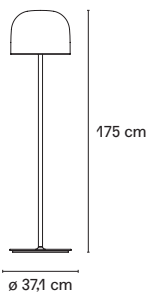

Possibilità di acquisto con tecnologia Dali o Casambi su richiesta
Dali or Casambi technology on request



| Codice Code | Materiale Material | Colore Colour | Sorgente luminosa Light source | Dimmer incluso Dimmer included | Classe energetica Energy label | Prezzo Retail con IVA Retail Price VAT incl. |
|----------------|---|---|---------------------------------|--------------------------------|--------------------------------|--|
| F439225550CRWL | Vetro, Metallo Galvanizzato Glass, Galvanized Metal |  Cromo Chrome | LED 40W (2700K, CRI>90, 4500Lm) | Si Yes | F | 2.310,00 € |
| F439225550NEWL | Vetro, Metallo Galvanizzato Glass, Galvanized Metal |  Nero lucido Glossy black | LED 40W (2700K, CRI>90, 4500Lm) | Si Yes | F | 2.310,00 € |
| F439225150OOWL | Vetro, Metallo Glass, Metal |  Oro opaco Matt gold | LED 40W (2700K, CRI>90, 4500Lm) | Si Yes | F | 2.420,00 € |
| F439225550RSWL | Vetro, Metallo Galvanizzato Glass, Galvanized Metal |  Rame lucido Glossy copper | LED 40W (2700K, CRI>90, 4500Lm) | Si Yes | F | 2.310,00 € |



LED integrato
Integrated LED



Possibilità di acquisto con tecnologia Dali o Casambi su richiesta
Dali or Casambi technology on request

FALENA
ALVARO SIZA
1994

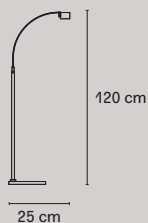

| Codice Code | Materiale Material | Colore Colour | Sorgente luminosa Light source | Dimmer incluso Dimmer included | Classe energetica Energy label | Prezzo Retail con IVA Retail Price VAT incl. |
|----------------|--------------------------------|-----------------|--------------------------------|--------------------------------|---|--|
| F301825150CRNE | Vetro, Metallo Glass, Metal | Cromo Chrome | 1x max 50W GY6.35 | No | Vedi tabella p. 181 See table p. 181 | 845,00 € |

CE ENEC Classe II IP20

FLÔTE
FRANCO RAGGI
1999



| Codice Code | Materiale Material | Colore Colour | Sorgente luminosa Light source | Dimmer incluso Dimmer included | Classe energetica Energy label | Prezzo Retail con IVA Retail Price VAT incl. |
|----------------|--------------------------------|---|--------------------------------|--------------------------------|---|--|
| F330025150TCNE | Vetro, Metallo Glass, Metal | Trasparente, Cromo Transparent, Chrome | 1x max 205W E27 | Sì Yes | Vedi tabella p. 181 See table p. 181 | 1.450,00 € |



CE ENEC Classe II IP20

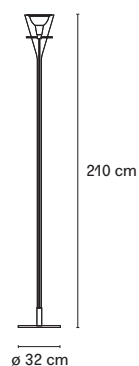

| Codice Code | Materiale Material | Colore Colour | Sorgente luminosa Light source | Dimmer incluso Dimmer included | Classe energetica Energy label | Prezzo Retail con IVA Retail Price VAT incl. |
|----------------|--------------------------------|---|--------------------------------|--------------------------------|---|--|
| F330030150TCNE | Vetro, Metallo Glass, Metal | Trasparente, Cromo Transparent, Chrome | 1x max 230W R7s/115 | Sì Yes | Vedi tabella p. 181 See table p. 181 | 2.800,00 € |



CE ENEC IP20

GALERIE
FEDERICO PERI
2017

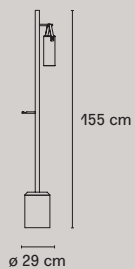

| Codice Code | Materiale Material | Colore Colour | Sorgente luminosa Light source | Dimmer incluso Dimmer included | Classe energetica Energy label | Prezzo Retail con IVA Retail Price VAT incl. |
|-------------------------------|---|--------------------------------------|----------------------------------|--------------------------------|--------------------------------|--|
| F440025500QZWL | Vetro, Metallo, Marmo Glass, Metal, Marble | Oro rosa, Bianco Rose gold, White | LED 6W (2700K, CRI>80, 850Lm) | Si Yes | E | 2.150,00 € |
| VETRO SOFFIATO BLOWN GLASS | | | LED integrato Integrated LED | | | |

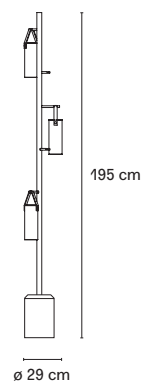

| Codice Code | Materiale Material | Colore Colour | Sorgente luminosa Light source | Dimmer incluso Dimmer included | Classe energetica Energy label | Prezzo Retail con IVA Retail Price VAT incl. |
|-------------------------------|---|--------------------------------------|--------------------------------------|--------------------------------|--------------------------------|--|
| F447630500QZWL | Vetro, Metallo, Marmo Glass, Metal, Marble | Oro rosa, Bianco Rose gold, White | LED 3x6W (2700K, CRI>80, 3x850Lm) | Si Yes | E | 3.300,00 € |
| VETRO SOFFIATO BLOWN GLASS | | | LED integrato Integrated LED | | | |

LUMEN
HISTORICAL ARCHIVE
1954



| Codice Code | Materiale Material | Colore Colour | Sorgente luminosa Light source | Dimmer incluso Dimmer included | Classe energetica Energy label | Prezzo Retail con IVA Retail Price VAT incl. |
|----------------|--------------------------------|---------------------------------------|--|--------------------------------|---|--|
| F248225150BINE | Vetro, Metallo Glass, Metal | <input type="radio"/> Bianco White | 4x max 46W E27* + 1x max 100W E27** | *Si Yes **No | Vedi tabella p. 181 See table p. 181 | 1.980,00 € |



Doppia accensione
Double light controls



LUMINATOR
PIETRO CHIESA
1933

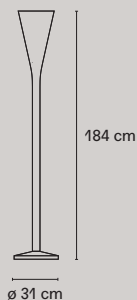

| Codice Code | Materiale Material | Colore Colour | Sorgente luminosa Light source | Dimmer incluso Dimmer included | Classe energetica Energy label | Prezzo Retail con IVA Retail Price VAT incl. |
|----------------|-------------------------------------|--|------------------------------------|--------------------------------|--------------------------------|--|
| F005630200NSWL | Metallo Metal | <input type="radio"/> Nichel Nickel | LED 30W (3000K, CRI>80, 3000Lm) | Si Yes | G | 2.500,00 € |
| F005630210BIWL | Metallo Verniciato Painted Metal | <input type="radio"/> Bianco White | LED 30W (3000K, CRI>80, 3000Lm) | Si Yes | G | 2.500,00 € |
| F005630210BLWL | Metallo Verniciato Painted Metal | <input type="radio"/> Blu Blue | LED 30W (3000K, CRI>80, 3000Lm) | Si Yes | G | 2.500,00 € |

LED integrato
Integrated LED



Su richiesta con
tecnologia Casambi
Casambi technology on
request

MERIDIANO
GABRIELE E OSCAR BURATTI
2020



| Codice Code | Materiale Material | Colore Colour | Sorgente luminosa Light source | Dimmer incluso Dimmer included | Classe energetica Energy label | Prezzo Retail con IVA Retail Price VAT incl. |
|----------------|--|---|---|-------------------------------------|--------------------------------|--|
| F441725550NFWL | Vetro, Metallo Galvanizzato Glass, Galvanized Metal | ● Nero, Fumè Black, Grey fumè | LED 25W (2700K, CRI>90, 2900Lm) + LED 8W (2700K, 1180Lm) | Si Yes | F | 2.200,00 € |
| F441725550NRWL | Vetro, Metallo Galvanizzato Glass, Galvanized Metal | ● Nero, Rosa Black, Pink | LED 25W (2700K, CRI>90, 2900Lm) + LED 8W (2700K, 1180Lm) | Si Yes | F | 2.200,00 € |
| F441725550NTWL | Vetro, Metallo Galvanizzato Glass, Galvanized Metal | ● Nero, Trasparente Black, Transparent | LED 25W (2700K, CRI>90, 2900Lm) + LED 8W (2700K, 1180Lm) | Si Yes | F | 2.200,00 € |
| | | | LED integrato Integrated LED | CE <small>Classe II</small> IP20 | | |
| | | | Su richiesta tecnologia Dali o Casambi Dali or Casambi technology on request | | | |



NASKA XL
HISTORICAL ARCHIVE
1933

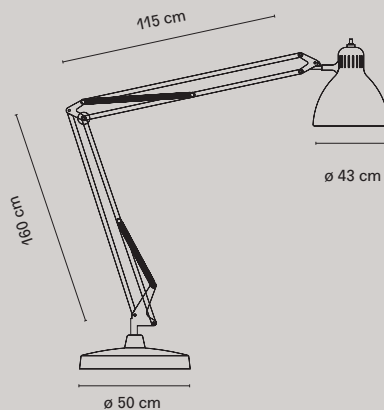

| Codice Code | Materiale Material | Colore Colour | Sorgente luminosa Light source | Dimmer incluso Dimmer included | Classe energetica Energy label | Prezzo Retail con IVA Retail Price VAT incl. |
|----------------|-------------------------------------|-------------------|--------------------------------|--------------------------------|---|--|
| F810525200BINE | Metallo Verniciato Painted Metal | ○ Bianco White | 1x max 42W E27 | Si Yes | Vedi tabella p. 181 See table p. 181 | 3.200,00 € |
| F810525200NENE | Metallo Verniciato Painted Metal | ● Nero Black | 1x max 42W E27 | Si Yes | Vedi tabella p. 181 See table p. 181 | 3.200,00 € |



OORT SISTEMA
JACOPO RODA
2022

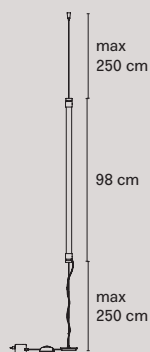

| Codice Code | Materiale Material | Colore Colour | Sorgente luminosa Light source | Dimmer incluso Dimmer included | Classe energetica Energy label | Prezzo Retail con IVA Retail Price VAT incl. |
|-------------|--|-------------------------------|-----------------------------------|--------------------------------|--------------------------------|--|
| OORT00001 | Vetro, Metallo Galvanizzato Glass, Galvanized Metal | ● Nichel nero Nickel black | LED 18W (3000K, 1700Lm) | Si, Yes | G | 660,00 € |
| OORT00010 | Vetro, Metallo Galvanizzato Glass, Galvanized Metal | ● Nichel nero Nickel black | LED 18W (DTW da 1800K a 4000K) | Si, Yes | G | 720,00 € |

LED integrato
Integrated LED



Su richiesta tecnologia
Casambi e 2700K
Casambi technology and
2700K on request

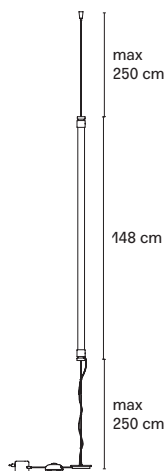

| Codice Code | Materiale Material | Colore Colour | Sorgente luminosa Light source | Dimmer incluso Dimmer included | Classe energetica Energy label | Prezzo Retail con IVA Retail Price VAT incl. |
|-------------|--|-------------------------------|-----------------------------------|--------------------------------|--------------------------------|--|
| OORT00002 | Vetro, Metallo Galvanizzato Glass, Galvanized Metal | ● Nichel nero Nickel black | LED 28W (3000K, 2660Lm) | Si, Yes | G | 740,00 € |
| OORT00011 | Vetro, Metallo Galvanizzato Glass, Galvanized Metal | ● Nichel nero Nickel black | LED 28W (DTW da 1800K a 4000K) | Si, Yes | G | 810,00 € |



LED integrato
Integrated LED

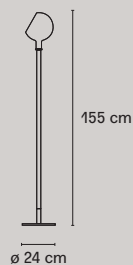

Su richiesta tecnologia
Casambi e 2700K
Casambi technology and
2700K on request

PAROLA
GAE AULENTI
E PIERO CASTIGLIONI
1980



| Codice Code | Materiale Material | Colore Colour | Sorgente luminosa Light source | Dimmer incluso Dimmer included | Classe energetica Energy label | Prezzo Retail con IVA Retail Price VAT incl. |
|----------------|-----------------------|---|-----------------------------------|-----------------------------------|---|---|
| F265925100AMNE | Vetro Glass |  Ambra Amber | 1x max 60W E14 | Si Yes | Vedi tabella p. 181 See table p. 181 | 1.050,00 € |
| F265925100BINE | Vetro Glass |  Bianco White | 1x max 60W E14 | Si Yes | Vedi tabella p. 181 See table p. 181 | 1.050,00 € |



CE ENEC IP20

PAROLONA
GAE AULENTI
E PIERO CASTIGLIONI
1980



| Codice Code | Materiale Material | Colore Colour | Sorgente luminosa Light source | Dimmer incluso Dimmer included | Classe energetica Energy label | Prezzo Retail con IVA Retail Price VAT incl. |
|----------------|-----------------------|---|-----------------------------------|-----------------------------------|---|---|
| F275130150BINE | Vetro Glass |  Bianco White | 1x max 60W E14 | Si Yes | Vedi tabella p. 181 See table p. 181 | 1.300,00 € |



CE ENEC IP20

PIRELLONE
GIO PONTI
1967





| Codice Code | Materiale Material | Colore Colour | Sorgente luminosa Light source | Dimmer incluso Dimmer included | Classe energetica Energy label | Prezzo Retail con IVA Retail Price VAT incl. |
|----------------|--------------------------------|---|--|-----------------------------------|---|---|
| F275930150KBNE | Vetro, Metallo Glass, Metal |  Nichel, Bianco Nickel, White | 10x max 33W G9 + 1x max 230W R7s/115* | *Sì Yes | Vedi tabella p. 181 See table p. 181 | 2.800,00 € |

Doppia accensione
Double light controls

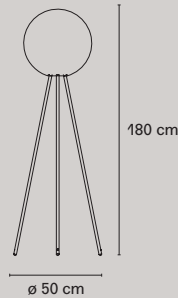

PRIMA SIGNORA
DANIELA PUPPA
1992



| Codice Code | Materiale Material | Colore Colour | Sorgente luminosa Light source | Dimmer incluso Dimmer included | Classe energetica Energy label | Prezzo Retail con IVA Retail Price VAT incl. |
|----------------|--------------------------------|--|-----------------------------------|-----------------------------------|---|---|
| F289130150CBNE | Vetro, Metallo Glass, Metal |  Cromo, Bianco Chrome, White | 1x max 205W E27 | Sì Yes | Vedi tabella p. 181 See table p. 181 | 1.350,00 € |



RILUMINATOR
PIETRO CHIESA
2014



| Codice Code | Materiale Material | Colore Colour | Sorgente luminosa Light source | Dimmer incluso Dimmer included | Classe energetica Energy label | Prezzo Retail con IVA Retail Price VAT incl. |
|----------------|-------------------------------------|-------------------|--|--|--------------------------------|--|
| F425930350BIWL | Polimero, Metallo Polymer, Metal | ○ Bianco White | LED 30W (3000K, CRI>80, 3000Lm) | Si Yes | G | 1.430,00 € |
| | | | LED integrato Integrated LED | CE ENEC <small>Classe #</small> IP20 | | |
| | | | Su richiesta con tecnologia Casambi Casambi technology on request | | | |

SCINTILLA
LIVIO E PIERO CASTIGLIONI
1972



| Codice Code | Materiale Material | Colore Colour | Sorgente luminosa Light source | Dimmer incluso Dimmer included | Classe energetica Energy label | Prezzo Retail con IVA Retail Price VAT incl. |
|----------------|--------------------------------|-----------------------------------|--------------------------------|--------------------------------|---|--|
| F272930250CRNE | Metallo, Vetro Metal, Glass | ● Cromo Chrome | 1x max 230W R7s/115 | Si Yes | Vedi tabella p. 181 See table p. 181 | 1.000,00 € |
| F272930250NSNE | Metallo, Vetro Metal, Glass | ● Nichel satinato Satin nickel | 1x max 230W R7s/115 | Si Yes | Vedi tabella p. 181 See table p. 181 | 1.000,00 € |

CE ENEC IP20

THEA
GABRIELE E OSCAR BURATTI
2022

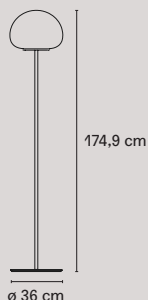

| Codice Code | Materiale Material | Colore Colour | Sorgente luminosa Light source | Dimmer incluso Dimmer included | Classe energetica Energy label | Prezzo Retail con IVA Retail Price VAT incl. |
|----------------|---|--|--------------------------------------|--------------------------------|--------------------------------|--|
| F444930550NFWL | Vetro, Metallo Galvanizzato Glass, Galvanized Metal | Nero lucido, Fumè Glossy black, Grey fumè | LED 11,6W (3000K, CRI>90, 1596Lm) | Si Yes | F | 1.800,00 € |
| F444930575RTWL | Vetro, Metallo Galvanizzato Glass, Galvanized Metal | Rame lucido, Trasparente Glossy copper, Transparent | LED 11,6W (3000K, CRI>90, 1596Lm) | Si Yes | F | 1.800,00 € |

VETRO SOFFIATO
BLOWN GLASS

LED integrato
Integrated LED

CE ^{Classe III} IP20

Su richiesta tecnologia
Casambi
Casambi technology on
request

TRIPOD
FRONT DESIGN
2017

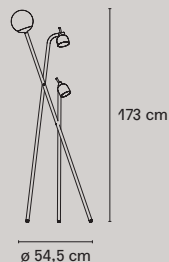

| Codice Code | Materiale Material | Colore Colour | Sorgente luminosa Light source | Dimmer incluso Dimmer included | Classe energetica Energy label | Prezzo Retail con IVA Retail Price VAT incl. |
|----------------|-----------------------------|------------------------------|---------------------------------------|--------------------------------|---|--|
| F439825150NENE | Vetro, Metallo Glass, Metal | Nero, Ottone Black, Brass | 1x max 105W E27* + 2x max 70W GU10 | *Si Yes | Vedi tabella p. 181 See table p. 181 | 1.980,00 € |

VETRO SOFFIATO
BLOWN GLASS

Doppia accensione
Double light controls

CE ENEC ^{Classe III} IP20

VERTIGO
MARCO ACERBIS
2005

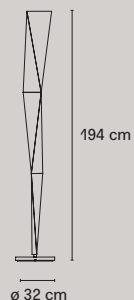

| Codice Code | Materiale Material | Colore Colour | Sorgente luminosa Light source | Dimmer incluso Dimmer included | Classe energetica Energy label | Prezzo Retail con IVA Retail Price VAT incl. |
|----------------|--------------------|---|---------------------------------|--------------------------------|--------------------------------|--|
| F553130240CRWL | Metallo Metal |  Acciaio Steel | LED 30W (3000K, CRI>80, 3000Lm) | Si Yes | G | 2.280,00 € |



LED integrato
Integrated LED

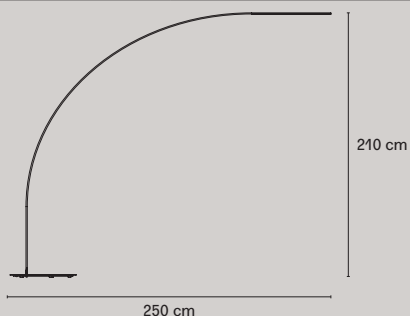

Su richiesta tecnologia
Casambi
Casambi technology on
request

YUMI
SHIGERU BAN
2011



| Codice Code | Materiale Material | Colore Colour | Sorgente luminosa Light source | Dimmer incluso Dimmer included | Classe energetica Energy label | Prezzo Retail con IVA Retail Price VAT incl. |
|----------------|--------------------|--|-------------------------------------|--------------------------------|--------------------------------|--|
| F414330200BIWL | Metallo Metal |  Bianco White | LED 240x22W (2700K, CRI>80, 2400Lm) | Si Yes | F | 2.180,00 € |
| F414330200NEWL | Metallo Metal |  Nero Black | LED 240x22W (2700K, CRI>80, 2400Lm) | Si Yes | F | 2.180,00 € |

LED integrato
Integrated LED



Su richiesta tecnologia
Casambi
Casambi technology on
request

LAMPADE A PARETE / WALL LAMPS

| | | | |
|--------------|-------|---------|-------|
| ALICANTO | p. 67 | SOLE | p. 80 |
| APEX | p. 68 | THEA | p. 80 |
| BIANCA | p. 68 | TROPICO | p. 81 |
| BONNET | p. 69 | | |
| BRUCO | p. 69 | | |
| FALENA | p. 69 | | |
| FLEX | p. 70 | | |
| FONTANELLA | p. 70 | | |
| FRENESI | p. 71 | | |
| GALERIE | p. 71 | | |
| IO | p. 71 | | |
| LUNAIRE | p. 72 | | |
| NASKA | p. 73 | | |
| NOBI | p. 74 | | |
| OORT SISTEMA | p. 75 | | |
| PALLINA | p. 75 | | |
| PAROLA | p. 76 | | |
| RIGA | p. 76 | | |
| SCINTILLA | p. 77 | | |
| SILLABA | p. 78 | | |
| SILLABONE | p. 79 | | |

ALICANTO
FRANCESCO LIBRIZZI
2021

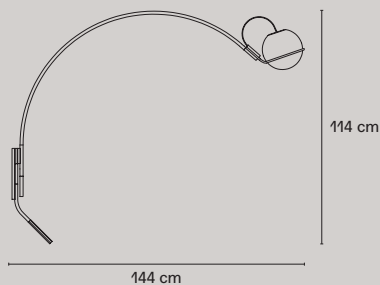

| Codice Code | Materiale Material | Colore Colour | Sorgente luminosa Light source | Dimmerabile Dimmable | Classe energetica Energy label | Prezzo Retail con IVA Retail Price VAT incl. |
|-------------|--------------------|---------------|--------------------------------|----------------------|--------------------------------|--|
|-------------|--------------------|---------------|--------------------------------|----------------------|--------------------------------|--|

| | | | | | | |
|----------------|---|-----------------|-----------------------------------|-----------|---|------------|
| F443645160NEWL | Vetro, Metallo Verniciato Glass, Painted Metal | ● Nero Black | LED 8W (3000K, CRI>90, 1180Lm) | Si Yes | F | 1.600,00 € |
|----------------|---|-----------------|-----------------------------------|-----------|---|------------|



LED integrato
Integrated LED



Su richiesta tecnologia
Casambi e 2700K
Casambi technology and
2700K on request

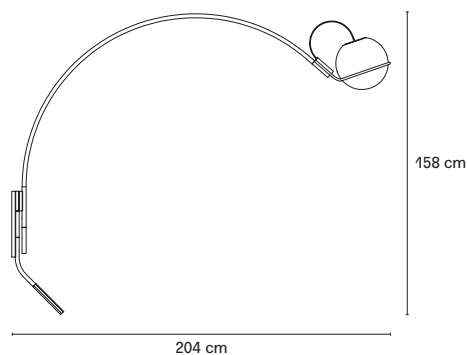

| Codice Code | Materiale Material | Colore Colour | Sorgente luminosa Light source | Dimmerabile Dimmable | Classe energetica Energy label | Prezzo Retail con IVA Retail Price VAT incl. |
|-------------|--------------------|---------------|--------------------------------|----------------------|--------------------------------|--|
|-------------|--------------------|---------------|--------------------------------|----------------------|--------------------------------|--|

| | | | | | | |
|----------------|---|-----------------|-----------------------------------|-----------|---|------------|
| F443650160NEWL | Vetro, Metallo Verniciato Glass, Painted Metal | ● Nero Black | LED 8W (3000K, CRI>90, 1180Lm) | Si Yes | F | 1.700,00 € |
|----------------|---|-----------------|-----------------------------------|-----------|---|------------|



LED integrato
Integrated LED



Su richiesta tecnologia
Casambi e 2700K
Casambi technology and
2700K on request

APEX
KARIM RASHID
2015

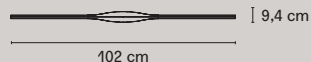

| Codice Code | Materiale Material | Colore Colour | Sorgente luminosa Light source | Dimmerabile Dimmable | Classe energetica Energy label | Prezzo Retail con IVA Retail Price VAT incl. |
|----------------|--------------------|---------------|--------------------------------------|-------------------------|--------------------------------|--|
| F431145200BILE | Metallo Metal | Bianco White | LED 2x7W (2700K, CRI>80, 2x900Lm) | Si, 1-10V Yes, 1-10V | F | 510,00 € |
| F431145200NELE | Metallo Metal | Nero Black | LED 2x7W (2700K, CRI>80, 2x900Lm) | Si, 1-10V Yes, 1-10V | F | 510,00 € |
| | | | LED integrato Integrated LED | | | |

BIANCA
MATTI KLENELL
2015

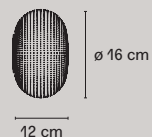

| Codice Code | Materiale Material | Colore Colour | Sorgente luminosa Light source | Dimmerabile Dimmable | Classe energetica Energy label | Prezzo Retail con IVA Retail Price VAT incl. |
|----------------|--------------------------------|---------------|------------------------------------|---|--------------------------------|--|
| F432860150BILE | Vetro, Metallo Glass, Metal | Bianco White | LED 4,5W (2700K, CRI>80, 350Lm) | Si, taglio di fase Yes, phase cut dimmer | F | 325,00 € |
| | | | LED integrato Integrated LED | | | |

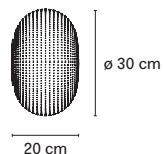

| Codice Code | Materiale Material | Colore Colour | Sorgente luminosa Light source | Dimmerabile Dimmable | Classe energetica Energy label | Prezzo Retail con IVA Retail Price VAT incl. |
|----------------|--------------------------------|---------------|--------------------------------------|-------------------------|--------------------------------|--|
| F432865150BILE | Vetro, Metallo Glass, Metal | Bianco White | LED 17,5W (2700K, CRI>80, 1650Lm) | Si, TRIAC Yes, TRIAC | E | 520,00 € |
| | | | LED integrato Integrated LED | | | |

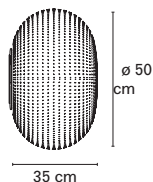

| Codice Code | Materiale Material | Colore Colour | Sorgente luminosa Light source | Dimmerabile Dimmable | Classe energetica Energy label | Prezzo Retail con IVA Retail Price VAT incl. |
|----------------|--------------------------------|---------------|--------------------------------|----------------------|---|--|
| F432870150BINE | Vetro, Metallo Glass, Metal | Bianco White | 1x max 116W E27 | Si Yes | Vedi tabella p. 181 See table p. 181 | 730,00 € |
| | | | | | | |



BONNET
ODO FIORAVANTI
2014

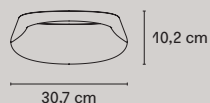

| Codice Code | Materiale Material | Colore Colour | Sorgente luminosa Light source | Dimmerabile Dimmable | Classe energetica Energy label | Prezzo Retail con IVA Retail Price VAT incl. |
|----------------|----------------------------------|----------------------|---------------------------------|--------------------------------------|--------------------------------|--|
| F443245200BILE | Metallo Metal | ○ Bianco White | LED 18W (2700K, CRI>80, 2300Lm) | Si, trailing edge Yes, trailing edge | E | 330,00 € |
| F443245230ALLE | Metallo Spazzolato Brushed Metal | ● Alluminio Aluminum | LED 18W (2700K, CRI>80, 2300Lm) | Si, trailing edge Yes, trailing edge | E | 420,00 € |
| F443345200BILE | Metallo Metal | ○ Bianco White | LED 18W (3000K, CRI>80, 2300Lm) | Si, trailing edge Yes, trailing edge | D | 330,00 € |
| F443345230ALLE | Metallo Spazzolato Brushed Metal | ● Alluminio Aluminum | LED 18W (3000K, CRI>80, 2300Lm) | Si, trailing edge Yes, trailing edge | D | 420,00 € |

LED integrato Integrated LED

CE ENEC IP20

BRUCO
VICO MAGISTRETTI
2003

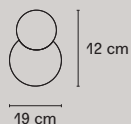

| Codice Code | Materiale Material | Colore Colour | Sorgente luminosa Light source | Dimmerabile Dimmable | Classe energetica Energy label | Prezzo Retail con IVA Retail Price VAT incl. |
|----------------|--------------------|----------------|--------------------------------|----------------------|--------------------------------------|--|
| F353845100BINE | Vetro Glass | ○ Bianco White | 1x max 46W E14 | Si Yes | Vedi tabella p. 181 See table p. 181 | 290,00 € |

VETRO SOFFIATO BLOWN GLASS

CE ENEC IP40

FALENA
ALVARO SIZA
1994

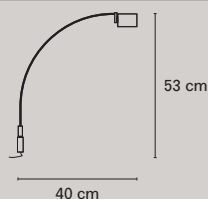

| Codice Code | Materiale Material | Colore Colour | Sorgente luminosa Light source | Dimmerabile Dimmable | Classe energetica Energy label | Prezzo Retail con IVA Retail Price VAT incl. |
|----------------|------------------------------|----------------|--------------------------------|----------------------|--------------------------------------|--|
| F301945150CRNE | Vetro, Metallo Glass, Metall | ● Cromo Chrome | 1x max 50W GY6.35 | No | Vedi tabella p. 181 See table p. 181 | 515,00 € |

CE ENEC IP20

FLEX
KARIM RASHID
2015

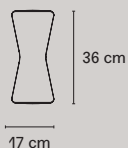

| Codice Code | Materiale Material | Colore Colour | Sorgente luminosa Light source | Dimmerabile Dimmable | Classe energetica Energy label | Prezzo Retail con IVA Retail Price VAT incl. |
|----------------|------------------------------|----------------|-------------------------------------|----------------------|--------------------------------|--|
| F431045200BILE | Vetro, Metallo Glass, Metall | ○ Bianco White | LED 2x13W (3000K, CRI>80, 2x1350Lm) | Si, 1-10V Yes, 1-10V | E | 345,00 € |
| F431045200NELE | Vetro, Metallo Glass, Metall | ● Nero Black | LED 2x13W (3000K, CRI>80, 2x1350Lm) | Si, 1-10V Yes, 1-10V | E | 345,00 € |



FONTANELLA
FEDERICO PERI
2020

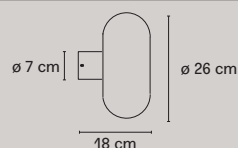

| Codice Code | Materiale Material | Colore Colour | Sorgente luminosa Light source | Dimmerabile Dimmable | Classe energetica Energy label | Prezzo Retail con IVA Retail Price VAT incl. |
|----------------|---|------------------------------|--------------------------------|----------------------|--------------------------------------|--|
| F447745550CRNE | Vetro, Metallo Galvanizzato Glass, Galvanized Metal | ● Cromo Chrome | 1x max 28W E14 | Si Yes | Vedi tabella p. 181 See table p. 181 | 525,00 € |
| F447745550NENE | Vetro, Metallo Galvanizzato Glass, Galvanized Metal | ● Nero lucido Glossy black | 1x max 28W E14 | Si Yes | Vedi tabella p. 181 See table p. 181 | 525,00 € |
| F447745550OTNE | Vetro, Metallo Galvanizzato Glass, Galvanized Metal | ● Ottone lucido Glossy Brass | 1x max 28W E14 | Si Yes | Vedi tabella p. 181 See table p. 181 | 545,00 € |

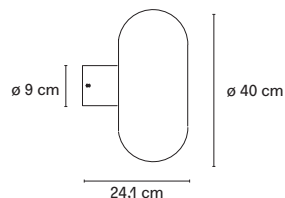

| Codice Code | Materiale Material | Colore Colour | Sorgente luminosa Light source | Dimmerabile Dimmable | Classe energetica Energy label | Prezzo Retail con IVA Retail Price VAT incl. |
|----------------|---|------------------------------|--------------------------------|----------------------|--------------------------------------|--|
| F447750550CRNE | Vetro, Metallo Galvanizzato Glass, Galvanized Metal | ● Cromo Chrome | 1x max 77W E27 | Si Yes | Vedi tabella p. 181 See table p. 181 | 785,00 € |
| F447750550NENE | Vetro, Metallo Galvanizzato Glass, Galvanized Metal | ● Nero lucido Glossy black | 1x max 77W E27 | Si Yes | Vedi tabella p. 181 See table p. 181 | 785,00 € |
| F447750550OTNE | Vetro, Metallo Galvanizzato Glass, Galvanized Metal | ● Ottone lucido Glossy Brass | 1x max 77W E27 | Si Yes | Vedi tabella p. 181 See table p. 181 | 805,00 € |



FRENESE
STUDIOLUCAGUADAGNINO
2022

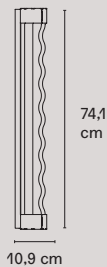

| Codice Code | Materiale Material | Colore Colour | Sorgente luminosa Light source | Dimmerabile Dimmable | Classe energetica Energy label | Prezzo Retail con IVA Retail Price VAT incl. |
|---------------------------------|--------------------------------|---|-------------------------------------|---|--------------------------------|--|
| F446745550TCLE | Vetro, Metallo Glass, Metal | Trasparente, Cromo Transparent, Chrome | LED 2x7W (2700K, CRI>90, 1550Lm) | Sì, a taglio di fase Yes, phase cut dimmer | G | 2.100,00 € |
| LED integrato Integrated LED | | | | IP40 | | |

GALERIE
FEDERICO PERI
2017

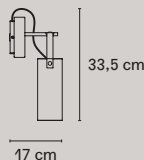

| Codice Code | Materiale Material | Colore Colour | Sorgente luminosa Light source | Dimmerabile Dimmable | Classe energetica Energy label | Prezzo Retail con IVA Retail Price VAT incl. |
|---------------------------------|---|--------------------------------------|-----------------------------------|-------------------------|--------------------------------|--|
| F439945500QZLE | Vetro, Metallo, Marmo Glass, Metal, Marble | Oro rosa, Bianco Rose gold, White | LED 8W (2700K, CRI>80, 1000Lm) | Sì, TRIAC Yes, TRIAC | E | 950,00 € |
| LED integrato Integrated LED | | | | IP20 | | |



IO
CLAESSON
KOIVISTO RUNE
2015

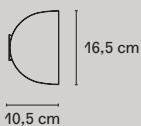

| Codice Code | Materiale Material | Colore Colour | Sorgente luminosa Light source | Dimmerabile Dimmable | Classe energetica Energy label | Prezzo retail Retail price |
|---------------------------------|--------------------|---------------------------|--|-------------------------|--------------------------------|----------------------------|
| F429945200BILE | Metallo Metal | Bianco White | LED 2x4,5W (2700K, CRI>90, 2x350Lm) | Sì, TRIAC Yes, TRIAC | F | 290,00 € |
| F429945200BLLE | Metallo Metal | Blu Blue | LED 2x4,5W (2700K, CRI>90, 2x350Lm) | Sì, TRIAC Yes, TRIAC | F | 340,00 € |
| F429945200GSLE | Metallo Metal | Grigio Scuro Dark gray | LED 2x4,5W (2700K, CRI>90, 2x350Lm) | Sì, TRIAC Yes, TRIAC | F | 340,00 € |
| F429945200ROLE | Metallo Metal | Rosso Red | LED 2x4,5W (2700K, CRI>90, 2x350Lm) | Sì, TRIAC Yes, TRIAC | F | 340,00 € |
| LED integrato Integrated LED | | | | IP40 | | |

LUNAIRE
FERRÉOL BABIN
2013

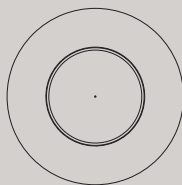

ø 75 cm

| Codice Code | Materiale Material | Colore Colour | Sorgente luminosa Light source | Dimmerabile Dimmable | Classe energetica Energy label | Prezzo Retail con IVA Retail Price VAT incl. |
|----------------|--|--------------------------------|--------------------------------------|----------------------|--------------------------------|--|
| F424665350BILE | Polimero, Metallo Verniciato Polymer, Painted Metal | ○ Bianco White | LED 28,6W (3000K, CRI>80, 3650Lm) | No | E | 990,00 € |
| F424665350NELE | Polimero, Metallo Verniciato Polymer, Painted Metal | ◐ Nero, Bianco Black, White | LED 28,6W (3000K, CRI>80, 3650Lm) | No | E | 990,00 € |
| F424665360RNLE | Polimero, Metallo Verniciato Polymer, Painted Metal | ◑ Rame, Nero Copper, Black | LED 28,6W (3000K, CRI>80, 3650Lm) | No | E | 1.990,00 € |
| F424665360ONLE | Polimero, Metallo Verniciato Polymer, Painted Metal | ◒ Oro, Nero Gold, Black | LED 28,6W (3000K, CRI>80, 3650Lm) | No | E | 1.990,00 € |
| F424665370RMLE | Polimero, Metallo Verniciato Polymer, Painted Metal | ◑ Rame Copper | LED 28,6W (3000K, CRI>80, 3650Lm) | No | E | 2.200,00 € |
| F424665370OOLE | Polimero, Metallo Verniciato Polymer, Painted Metal | ◒ Oro Gold | LED 28,6W (3000K, CRI>80, 3650Lm) | No | E | 2.200,00 € |

LED integrato
Integrated LED

CE ENEC IP40

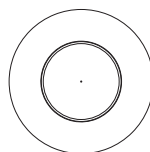

ø 50 cm



| Codice Code | Materiale Material | Colore Colour | Sorgente luminosa Light source | Dimmerabile Dimmable | Classe energetica Energy label | Prezzo Retail con IVA Retail Price VAT incl. |
|----------------|--|-------------------|------------------------------------|-------------------------|--------------------------------|--|
| F424660350BILE | Polimero, Metallo Verniciato Polymer, Painted Metal | ○ Bianco White | LED 10W (2700K, CRI 80, 1250Lm) | Si, TRIAC Yes, TRIAC | F | 650,00 € |

LED integrato
Integrated LED

CE ENEC IP20

NASKA
HISTORICAL ARCHIVE
1933

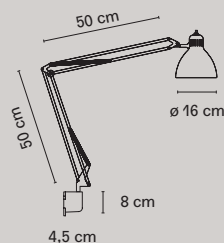

| Codice Code | Materiale Material | Colore Colour | Sorgente luminosa Light source | Dimmerabile Dimmable | Classe energetica Energy label | Prezzo Retail con IVA Retail Price VAT incl. |
|----------------|---------------------------------------|----------------|--------------------------------|----------------------|--------------------------------------|--|
| F810350200BINE | Metallo Verniciato Painted Metal | ○ Bianco White | 1x max 46W E27 | No | Vedi tabella p. 181 See table p. 181 | 440,00 € |
| F810350240CRNE | Metallo Galvanizzato Galvanized Metal | ◐ Cromo Chrome | 1x max 46W E27 | No | Vedi tabella p. 181 See table p. 181 | 510,00 € |
| F810350200NENE | Metallo Verniciato Painted Metal | ● Nero Black | 1x max 46W E27 | No | Vedi tabella p. 181 See table p. 181 | 440,00 € |

CE ENEC Classe III IP20

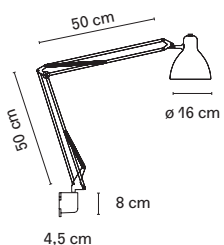

| Codice Code | Materiale Material | Colore Colour | Sorgente luminosa Light source | Dimmerabile Dimmable | Classe energetica Energy label | Prezzo Retail con IVA Retail Price VAT incl. |
|----------------|---------------------------------------|-------------------------|--------------------------------|----------------------|--------------------------------|--|
| F810350200BIWL | Metallo Verniciato Painted Metal | ○ Bianco White | LED 6W (2700K, CRI>80, 800Lm) | Si, touch Yes, touch | F | 485,00 € |
| F810350240CRWL | Metallo Galvanizzato Galvanized Metal | ◐ Cromo Chrome | LED 6W (2700K, CRI>80, 800Lm) | Si, touch Yes, touch | F | 580,00 € |
| F810350200NEWL | Metallo Verniciato Painted Metal | ● Nero Black | LED 6W (2700K, CRI>80, 800Lm) | Si, touch Yes, touch | F | 485,00 € |
| F810350240OOWL | Metallo Galvanizzato Galvanized Metal | ◑ Oro, Nero Gold, Black | LED 6W (2700K, CRI>80, 800Lm) | Si, touch Yes, touch | F | 580,00 € |

LED integrato Integrated LED

CE ENEC Classe III IP20

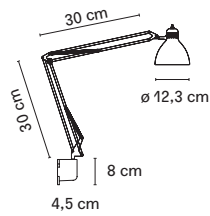

| Codice Code | Materiale Material | Colore Colour | Sorgente luminosa Light source | Dimmerabile Dimmable | Classe energetica Energy label | Prezzo Retail con IVA Retail Price VAT incl. |
|----------------|--|-------------------|--------------------------------|----------------------|---|--|
| F810340200BINE | Metallo Verniciato Painted Metal | ○ Bianco White | 1x max 46W E27 | No | Vedi tabella p. 181 See table p. 181 | 430,00 € |
| F810340240CRNE | Metallo Galvanizzato Galvanized Metal | ● Cromo Chrome | 1x max 46W E27 | No | Vedi tabella p. 181 See table p. 181 | 490,00 € |
| F810340200NENE | Metallo Verniciato Painted Metal | ● Nero Black | 1x max 46W E27 | No | Vedi tabella p. 181 See table p. 181 | 430,00 € |



NOBI METIS LIGHTING 1992



| Codice Code | Materiale Material | Colore Colour | Sorgente luminosa Light source | Dimmerabile Dimmable | Classe energetica Energy label | Prezzo Retail con IVA Retail Price VAT incl. |
|----------------|---------------------------------|-------------------|--------------------------------|----------------------|---|--|
| F302345150BINE | Vetro, Metallo Glass, Metall | ○ Bianco White | 1x max 120W R7s/80 | Si Yes | Vedi tabella p. 181 See table p. 181 | 350,00 € |

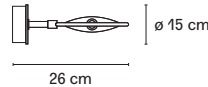

| Codice Code | Materiale Material | Colore Colour | Sorgente luminosa Light source | Dimmerabile Dimmable | Classe energetica Energy label | Prezzo Retail con IVA Retail Price VAT incl. |
|----------------|---------------------------------|-----------------------------------|------------------------------------|-------------------------|--------------------------------|--|
| F302345150CRLE | Vetro, Metallo Glass, Metall | ● Cromo Chrome | LED 14W (2700K, CRI>80, 1400Lm) | Si, 1-10V Yes, 1-10V | F | 470,00 € |
| F302345150NSLE | Vetro, Metallo Glass, Metall | ● Nichel satinato Satin nickel | LED 14W (2700K, CRI>80, 1400Lm) | Si, 1-10V Yes, 1-10V | F | 470,00 € |

LED integrato
Integrated LED



OORT SISTEMA
JACOPO RODA
2022

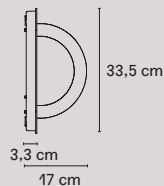

| Codice Code | Materiale Material | Colore Colour | Sorgente luminosa Light source | Dimmerabile Dimmable | Classe energetica Energy label | Prezzo Retail con IVA Retail Price VAT incl. |
|--|--------------------------------|-----------------------------------|-----------------------------------|---|-----------------------------------|---|
| OORT00030 | Vetro, Metallo Glass, Metal | Bianco, Specchio White, Mirror | LED 8W (3000K, 760Lm) | Si, 1-10V/PUSH Yes, 1-10V/PUSH | G | 460,00 € |
| OORT00031 | Vetro, Metallo Glass, Metal | Bianco, Specchio White, Mirror | LED 8W (DTW da 1800K a 4000K) | Si, 1-10V/PUSH Yes, 1-10V/PUSH | G | 490,00 € |
| LED integrato Integrated LED | | | | IP20* | | |
| Su richiesta 2700K 2700K on request | | | | *su richiesta IP44 dimmerabile Triac dimmmable Triac IP44 on request | | |

PALLINA
FONTANAARTE DESIGN LAB
2019

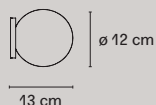



| Codice Code | Materiale Material | Colore Colour | Sorgente luminosa Light source | Dimmerabile Dimmable | Classe energetica Energy label | Prezzo Retail con IVA Retail Price VAT incl. |
|----------------|--|--------------------------------|-----------------------------------|-------------------------|---|---|
| F443060150NENE | Vetro, Metallo Galvanizzato Glass, Galvanized Metal | Nero lucido Glossy black | 1x max 6W G9 | Si Yes | Vedi tabella p. 181 See table p. 181 | 275,00 € |
| F443060150NSNE | Vetro, Metallo Galvanizzato Glass, Galvanized Metal | Nichel lucido Glossy nickel | 1x max 6W G9 | Si Yes | Vedi tabella p. 181 See table p. 181 | 275,00 € |
| F443060150OTNE | Vetro, Metallo Galvanizzato Glass, Galvanized Metal | Ottone lucido Glossy brass | 1x max 6W G9 | Si Yes | Vedi tabella p. 181 See table p. 181 | 275,00 € |
| F443060150ORNE | Vetro, Metallo Verniciato Glass, Painted Metal | Oro rosa Rose gold | 1x max 6W G9 | Si Yes | Vedi tabella p. 181 See table p. 181 | 300,00 € |

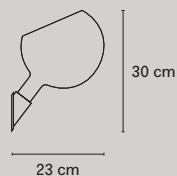

PAROLA
GAE AULENTI
E PIERO CASTIGLIONI
1980







| Codice Code | Materiale Material | Colore Colour | Sorgente luminosa Light source | Dimmerabile Dimmable | Classe energetica Energy label | Prezzo Retail con IVA Retail Price VAT incl. |
|----------------|--------------------|---|--------------------------------|----------------------|---|--|
| F268945150AMNE | Vetro Glass |  Ambra Amber | 1x max 46W E14 | Si Yes | Vedi tabella p. 181 See table p. 181 | 730,00 € |
| F268945150BINE | Vetro Glass |  Bianco White | 1x max 46W E14 | Si Yes | Vedi tabella p. 181 See table p. 181 | 730,00 € |

 VETRO SOFFIATO
BLOWN GLASS

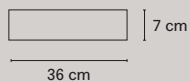

RIGA
PAOLO ZANI
1995



| Codice Code | Materiale Material | Colore Colour | Sorgente luminosa Light source | Dimmerabile Dimmable | Classe energetica Energy label | Prezzo Retail con IVA Retail Price VAT incl. |
|----------------|---------------------------------|---|--------------------------------------|--|--------------------------------|--|
| F521440260AXLE | Vetro, Metallo Glass, Metall |  Acciaio Steel | LED 2x9W (3000K, CRI>80, 2x850Lm) | Si, a taglio di fase Yes, phase cut dimmer | E | 400,00 € |
| F521440250BILE | Vetro, Metallo Glass, Metall |  Bianco White | LED 2x9W (3000K, CRI>80, 2x850Lm) | Si, a taglio di fase Yes, phase cut dimmer | E | 360,00 € |
| F521440260NSLE | Vetro, Metallo Glass, Metall |  Nichel satinato Satin nickel | LED 2x9W (3000K, CRI>80, 2x850Lm) | Si, a taglio di fase Yes, phase cut dimmer | E | 400,00 € |

LED integrato
Integrated LED





| Codice Code | Materiale Material | Colore Colour | Sorgente luminosa Light source | Dimmerabile Dimmable | Classe energetica Energy label | Prezzo Retail con IVA Retail Price VAT incl. |
|------------------------------|------------------------------|------------------------------|-----------------------------------|--|--------------------------------|--|
| F539845260AXLE | Vetro, Metallo Glass, Metall | Acciaio Steel | LED 2x9W (3000K, CRI>80, 2x850Lm) | Si, a taglio di fase Yes, phase cut dimmer | E | 450,00 € |
| F539845250BILE | Vetro, Metallo Glass, Metall | Bianco White | LED 2x9W (3000K, CRI>80, 2x850Lm) | Si, a taglio di fase Yes, phase cut dimmer | E | 410,00 € |
| F539845260NSLE | Vetro, Metallo Glass, Metall | Nichel satinato Satin nickel | LED 2x9W (3000K, CRI>80, 2x850Lm) | Si, a taglio di fase Yes, phase cut dimmer | E | 450,00 € |
| LED integrato Integrated LED | | | | | | |

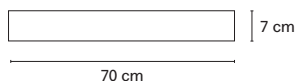

| Codice Code | Materiale Material | Colore Colour | Sorgente luminosa Light source | Dimmerabile Dimmable | Classe energetica Energy label | Prezzo Retail con IVA Retail Price VAT incl. |
|------------------------------|------------------------------|------------------------------|-------------------------------------|--|--------------------------------|--|
| F521450260AXLE | Vetro, Metallo Glass, Metall | Acciaio Steel | LED 2x9,5W (3000K, CRI>80, 2x910Lm) | Si, a taglio di fase Yes, phase cut dimmer | E | 560,00 € |
| F521450250BILE | Vetro, Metallo Glass, Metall | Bianco White | LED 2x9,5W (3000K, CRI>80, 2x910Lm) | Si, a taglio di fase Yes, phase cut dimmer | E | 520,00 € |
| F521450260NSLE | Vetro, Metallo Glass, Metall | Nichel satinato Satin nickel | LED 2x9,5W (3000K, CRI>80, 2x910Lm) | Si, a taglio di fase Yes, phase cut dimmer | E | 560,00 € |
| LED integrato Integrated LED | | | | | | |

SCINTILLA LIVIO E PIERO CASTIGLIONI 1972

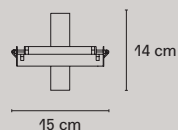

| Codice Code | Materiale Material | Colore Colour | Sorgente luminosa Light source | Dimmerabile Dimmable | Classe energetica Energy label | Prezzo Retail con IVA Retail Price VAT incl. |
|----------------|------------------------------|------------------------------|--------------------------------|----------------------|--------------------------------------|--|
| FP15045250CRNE | Vetro, Metallo Glass, Metall | Cromo Chrome | 1x max 120W R7s/80 | Si Yes | Vedi tabella p. 181 See table p. 181 | 300,00 € |
| FP15045250NSNE | Vetro, Metallo Glass, Metall | Nichel satinato Satin nickel | 1x max 120W R7s/80 | Si Yes | Vedi tabella p. 181 See table p. 181 | 300,00 € |



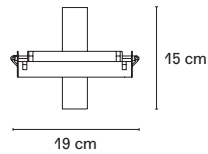

| Codice Code | Materiale Material | Colore Colour | Sorgente luminosa Light source | Dimmerabile Dimmable | Classe energetica Energy label | Prezzo Retail con IVA Retail Price VAT incl. |
|----------------|---------------------------------|---------------------------------|--------------------------------|----------------------|---|--|
| FP30050250CRNE | Vetro, Metallo Glass, Metall | Cromo Chrome | 1x max 230W R7s/115 | Si Yes | Vedi tabella p. 181 See table p. 181 | 350,00 € |
| FP30050250NSNE | Vetro, Metallo Glass, Metall | Nichel satinato Satin nickel | 1x max 230W R7s/115 | Si Yes | Vedi tabella p. 181 See table p. 181 | 350,00 € |



| Codice Code | Materiale Material | Colore Colour | Descrizione Description | Prezzo Retail con IVA Retail Price VAT incl. |
|----------------|--------------------|-----------------------|---|--|
| RS15000M02AL00 | Metallo Metall | Alluminio Aluminum | Riflettore per FP15045250..NE, Reflector for FP15045250..NE | 40,00 € |
| RS30000M02AL00 | Metallo Metall | Alluminio Aluminum | Riflettore per FP30050250..NE, Reflector for FP30050250..NE | 50,00 € |

SILLABA PIERO CASTIGLIONI 1988

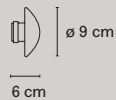

| Codice Code | Materiale Material | Colore Colour | Sorgente luminosa Light source | Dimmerabile Dimmable | Classe energetica Energy label | Prezzo Retail con IVA Retail Price VAT incl. |
|----------------|---------------------------------|-----------------|--------------------------------|----------------------|---|--|
| F277560150BINE | Vetro, Metallo Glass, Metall | Bianco White | 1x max 20W G4 | Si Yes | Vedi tabella p. 181 See table p. 181 | 130,00 € |



Alimentatore non
incluso
Ballast not included

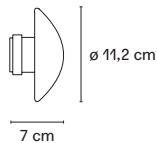

| Codice Code | Materiale Material | Colore Colour | Sorgente luminosa Light source | Dimmerabile Dimmable | Classe energetica Energy label | Prezzo Retail con IVA Retail Price VAT incl. |
|----------------|---------------------------------|-----------------|--------------------------------|----------------------|---|--|
| F277565150BINE | Vetro, Metallo Glass, Metall | Bianco White | 1x max 50W GY6.35 | Si Yes | Vedi tabella p. 181 See table p. 181 | 200,00 € |



Alimentatore non
incluso
Ballast not included

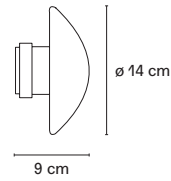

| Codice Code | Materiale Material | Colore Colour | Sorgente luminosa Light source | Dimmerabile Dimmable | Classe energetica Energy label | Prezzo Retail con IVA Retail Price VAT incl. |
|----------------|---------------------------------|-------------------|--------------------------------|----------------------|---|--|
| F277570150BINE | Vetro, Metallo Glass, Metall | ○ Bianco White | 1x max 60W G9 | Si Yes | Vedi tabella p. 181 See table p. 181 | 215,00 € |



| Codice Code | Materiale Material | Colore Colour | Sorgente luminosa Light source | Dimmerabile Dimmable | Classe energetica Energy label | Prezzo Retail con IVA Retail Price VAT incl. |
|----------------|---------------------------------|-------------------|------------------------------------|---|--------------------------------|--|
| F277570150BILE | Vetro, Metallo Glass, Metall | ○ Bianco White | LED 1x8W (3000K, CRI>80, 650Lm) | Si, a taglio di fase Yes, phase cut dimmer | F | 360,00 € |

LED integrato
Integrated LED



SILLABONE PIERO CASTIGLIONI 1988

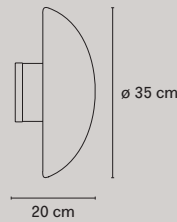

| Codice Code | Materiale Material | Colore Colour | Sorgente luminosa Light source | Dimmerabile Dimmable | Classe energetica Energy label | Prezzo Retail con IVA Retail Price VAT incl. |
|----------------|---------------------------------|-------------------|--------------------------------|----------------------|---|--|
| F279370150BINE | Vetro, Metallo Glass, Metall | ○ Bianco White | 1x max 100W E27 | Si Yes | Vedi tabella p. 181 See table p. 181 | 410,00 € |



SOLE
BERNARDINO AMATO
2011

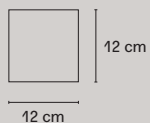

| Codice Code | Materiale Material | Colore Colour | Sorgente luminosa Light source | Dimmerabile Dimmable | Classe energetica Energy label | Prezzo Retail con IVA Retail Price VAT incl. |
|----------------|-------------------------------------|-----------------|-------------------------------------|-------------------------|--------------------------------|--|
| F414040150BILE | Vetro, Polimero Glass, Polymer | Bianco White | LED 49x9W (3000K, CRI>85, 800Lm) | Si, TRIAC Yes, TRIAC | D | 375,00 € |
| | | | LED integrato Integrated LED | | Classe II IP44 | |
| F413940150BILE | Vetro, Polimero Glass, Polymer | Bianco White | LED 49x9W (3000K, CRI>85, 800Lm) | Si, TRIAC Yes, TRIAC | D | 2.050,00 € |
| | Confezione da 6 pz Pack of 6 pcs | | LED integrato Integrated LED | | Classe II IP44 | |

THEA
GABRIELE E OSCAR BURATTI
2022

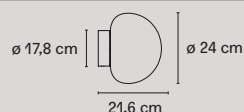

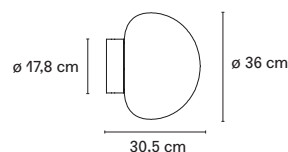

| Codice Code | Materiale Material | Colore Colour | Sorgente luminosa Light source | Dimmerabile Dimmable | Classe energetica Energy label | Prezzo Retail con IVA Retail Price VAT incl. |
|-----------------|--|--|--------------------------------------|-----------------------------------|--------------------------------|--|
| F444965550NFLE | Vetro, Metallo Galvanizzato Glass, Galvanized Metal | Nero lucido, Fumè Glossy black, Grey fumè | LED 3,85W (3000K, CRI>90, 640Lm) | Si, TRIAC Yes, TRIAC | F | 920,00 € |
| F444965575RTLLE | Vetro, Metallo Galvanizzato Glass, Galvanized Metal | Rame lucido, Trasparente Glossy copper, Transparent | LED 3,85W (3000K, CRI>90, 640Lm) | Si, TRIAC Yes, TRIAC | F | 920,00 € |
| | VETRO SOFFIATO BLOWN GLASS | | LED integrato Integrated LED | IP40 | | |
| F444970550NFLE | Vetro, Metallo Galvanizzato Glass, Galvanized Metal | Nero lucido, Fumè Glossy black, Grey fumè | LED 11,6W (3000K, CRI>90, 1596Lm) | Si, 1-10V/PUSH Yes, 1-10V/PUSH | F | 1.540,00 € |
| F444970575RTLLE | Vetro, Metallo Galvanizzato Glass, Galvanized Metal | Rame lucido, Trasparente Glossy copper, Transparent | LED 11,6W (3000K, CRI>90, 1596Lm) | Si, 1-10V/PUSH Yes, 1-10V/PUSH | F | 1.540,00 € |
| | VETRO SOFFIATO BLOWN GLASS | | LED integrato Integrated LED | IP40 | | |



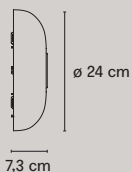

TROPICO
GABRIELE E OSCAR BURATTI
2020

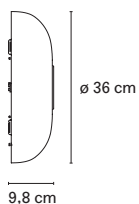

| Codice Code | Materiale Material | Colore Colour | Sorgente luminosa Light source | Dimmerabile Dimmable | Classe energetica Energy label | Prezzo Retail con IVA Retail Price VAT incl. |
|---|---|-------------------------------|--------------------------------------|--|--------------------------------|--|
| F442160550NELE | Vetro, Metallo Galvanizzato Glass, Galvanized Metall | ● Nero lucido Glossy black | LED 20,5W (3000K, CRI>80, 2200Lm) | Si, a taglio di fase Yes, phase cut dimmer | F | 470,00 € |
| F442160550OOLE | Vetro, Metallo Galvanizzato Glass, Galvanized Metal | ● Oro lucido Glossy gold | LED 20,5W (3000K, CRI>80, 2200Lm) | Si, a taglio di fase Yes, phase cut dimmer | F | 470,00 € |
|  VETRO SOFFIATO BLOWN GLASS | | | LED integrato Integrated LED |  IP20 | | |



| Codice Code | Materiale Material | Colore Colour | Sorgente luminosa Light source | Dimmerabile Dimmable | Classe energetica Energy label | Prezzo Retail con IVA Retail Price VAT incl. |
|--|---|-------------------------------|--------------------------------------|---|--------------------------------|--|
| F442165550NELE | Vetro, Metallo Galvanizzato Glass, Galvanized Metall | ● Nero lucido Glossy black | LED 30,5W (3000K, CRI>80, 3000Lm) | Si, a taglio di fase Yes, phase cut dimmer | E | 590,00 € |
| F442165550OOLE | Vetro, Metallo Galvanizzato Glass, Galvanized Metal | ● Oro lucido Glossy gold | LED 30,5W (3000K, CRI>80, 3000Lm) | Si, a taglio di fase Yes, phase cut dimmer | E | 590,00 € |
|  VETRO SOFFIATO BLOWN GLASS | | | LED integrato Integrated LED |  IP20 | | |

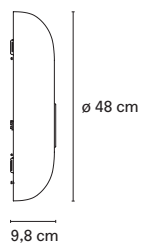

| Codice Code | Materiale Material | Colore Colour | Sorgente luminosa Light source | Dimmerabile Dimmable | Classe energetica Energy label | Prezzo Retail con IVA Retail Price VAT incl. |
|---|---|-------------------------------|---|---|--------------------------------|--|
| F442170550NELE | Vetro, Metallo Galvanizzato Glass, Galvanized Metall | ● Nero lucido Glossy black | LED 42,5W (3000K, CRI>80, 4600Lm) | Si, a taglio di fase F Yes, phase cut dimmer | | 780,00 € |
| F442170550OOLE | Vetro, Metallo Galvanizzato Glass, Galvanized Metal | ● Oro lucido Glossy gold | LED 42,5W (3000K, CRI>80, 4600Lm) | Si, a taglio di fase F Yes, phase cut dimmer | | 780,00 € |
|  | | | LED integrato Integrated LED | CE IP20 | | |
| KIT CASAMBI R442100K05BI00 | Casambi è un dispositivo intelligente, non è necessaria una connessione Internet ma è sufficiente attivare il Bluetooth del telefono o tablet o altri dispositivi di controllo e scaricare la App gratuita grazie alla quale le lampade potranno venire accese, spente e regolate di intensità a seconda dello scenario che si desidera nel proprio ambiente. | | Casambi is an intelligent device, no Internet connection is required, simply activate the Bluetooth on your phone, tablet or other control device and download the free App to turn the lamps on and off and adjust their intensity according to the scenario you want to create in your environment. | | | 156,00 € |

LAMPADE A PLAFONE / CEILING LAMPS

| | |
|--------------|-------|
| BIANCA | p. 85 |
| FONTANELLA | p. 86 |
| FRENESI | p. 87 |
| LUNAIRE | p. 87 |
| OORT SISTEMA | p. 87 |
| PALLINA | p. 88 |
| PANGEN | p. 89 |
| SILLABA | p. 89 |
| SILLABONE | p. 90 |
| SOLE | p. 90 |
| THEA | p. 91 |
| TROPICO | p. 92 |

BIANCA
MATTI KLENELL
2015



ø 16 cm

12 cm



| Codice Code | Materiale Material | Colore Colour | Sorgente luminosa Light source | Dimmerabile Dimmable | Classe energetica Energy label | Prezzo Retail con IVA Retail Price VAT incl. |
|----------------|--------------------------------|-------------------|------------------------------------|--|-----------------------------------|---|
| F432860150BILE | Vetro, Metallo Glass, Metal | ○ Bianco White | LED 4,5W (2700K, CRI>80, 350Lm) | Si, taglio di fase Yes, phase cut dimmer | F | 325,00 € |



LED integrato
Integrated LED



ø 30 cm

20 cm

| Codice Code | Materiale Material | Colore Colour | Sorgente luminosa Light source | Dimmerabile Dimmable | Classe energetica Energy label | Prezzo Retail con IVA Retail Price VAT incl. |
|----------------|--------------------------------|-------------------|--------------------------------------|-------------------------|-----------------------------------|---|
| F432865150BILE | Vetro, Metallo Glass, Metal | ○ Bianco White | LED 17,5W (2700K, CRI>80, 1650Lm) | Si, TRIAC Yes, TRIAC | E | 520,00 € |



LED integrato
Integrated LED



ø 50 cm



35 cm

| Codice Code | Materiale Material | Colore Colour | Sorgente luminosa Light source | Dimmerabile Dimmable | Classe energetica Energy label | Prezzo Retail con IVA Retail Price VAT incl. |
|----------------|--------------------------------|-------------------|-----------------------------------|-------------------------|---|---|
| F432870150BINE | Vetro, Metallo Glass, Metal | ○ Bianco White | 1x max 116W E27 | Si Yes | Vedi tabella p. 181 See table p. 181 | 730,00 € |

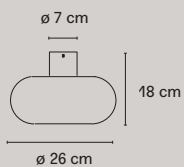

FONTANELLA
FEDERICO PERI
2020





| Codice Code | Materiale Material | Colore Colour | Sorgente luminosa Light source | Dimmerabile Dimmable | Classe energetica Energy label | Prezzo Retail con IVA Retail Price VAT incl. |
|----------------|--|---|--------------------------------|----------------------|---|--|
| F447745550CRNE | Vetro, Metallo Galvanizzato Glass, Galvanized Metal |  Cromo Chrome | 1x max 28W E14 | Si Yes | Vedi tabella p. 181 See table p. 181 | 525,00 € |
| F447745550NENE | Vetro, Metallo Galvanizzato Glass, Galvanized Metal |  Nero lucido Glossy black | 1x max 28W E14 | Si Yes | Vedi tabella p. 181 See table p. 181 | 525,00 € |
| F447745550OTNE | Vetro, Metallo Galvanizzato Glass, Galvanized Metal |  Ottone lucido Glossy Brass | 1x max 28W E14 | Si Yes | Vedi tabella p. 181 See table p. 181 | 545,00 € |

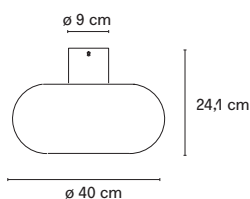

CE IP20





| Codice Code | Materiale Material | Colore Colour | Sorgente luminosa Light source | Dimmerabile Dimmable | Classe energetica Energy label | Prezzo Retail con IVA Retail Price VAT incl. |
|----------------|--|---|--------------------------------|----------------------|---|--|
| F447750550CRNE | Vetro, Metallo Galvanizzato Glass, Galvanized Metal |  Cromo Chrome | 1x max 77W E27 | Si Yes | Vedi tabella p. 181 See table p. 181 | 785,00 € |
| F447750550NENE | Vetro, Metallo Galvanizzato Glass, Galvanized Metal |  Nero lucido Glossy black | 1x max 77W E27 | Si Yes | Vedi tabella p. 181 See table p. 181 | 785,00 € |
| F447750550OTNE | Vetro, Metallo Galvanizzato Glass, Galvanized Metal |  Ottone lucido Glossy Brass | 1x max 77W E27 | Si Yes | Vedi tabella p. 181 See table p. 181 | 805,00 € |



CE IP20

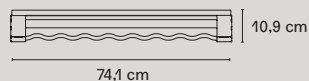

FRENESE STUDIOLUCAGUADAGNINO 2022

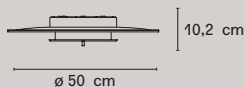

| Codice Code | Materiale Material | Colore Colour | Sorgente luminosa Light source | Dimmerabile Dimmable | Classe energetica Energy label | Prezzo Retail con IVA Retail Price VAT incl. |
|---------------------------------|--------------------------------|---|-------------------------------------|--|--------------------------------|--|
| F446745550TCLE | Vetro, Metallo Glass, Metal |  Trasparente, Cromo Transparent, Chrome | LED 2x7W (2700K, CRI>90, 1550Lm) | Si, a taglio di fase Yes, phase cut dimmer | G | 2.100,00 € |
| LED integrato Integrated LED | | | |  IP40 | | |

LUNAIRE FERRÉOL BABIN 2013





| Codice Code | Materiale Material | Colore Colour | Sorgente luminosa Light source | Dimmerabile Dimmable | Classe energetica Energy label | Prezzo Retail con IVA Retail Price VAT incl. |
|---------------------------------|--|---|------------------------------------|---|--------------------------------|--|
| F424660350BILE | Polimero, Metallo Verniciato Polymer, Painted Metal |  Bianco White | LED 10W (2700K, CRI 80, 1250Lm) | No | E | 650,00 € |
| LED integrato Integrated LED | | | |  ENEC IP20 | | |



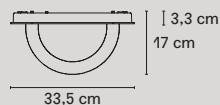

OORT SISTEMA JACOPO RODA 2022

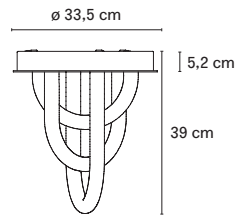

| Codice Code | Materiale Material | Colore Colour | Sorgente luminosa Light source | Dimmerabile Dimmable | Classe energetica Energy label | Prezzo Retail con IVA Retail Price VAT incl. |
|--|--------------------------------|---|----------------------------------|---|--------------------------------|--|
| OORT00030 | Vetro, Metallo Glass, Metal |  Bianco, Specchio White, Mirror | LED 8W (3000K, 760Lm) | Si, 1-10V/PUSH Yes, 1-10V/PUSH | G | 460,00 € |
| OORT00031 | Vetro, Metallo Glass, Metal |  Bianco, Specchio White, Mirror | LED 8W (DTW da 1800K a 4000K) | Si, 1-10V/PUSH Yes, 1-10V/PUSH | G | 490,00 € |
| LED integrato Integrated LED | | | |  IP20* | | |
| Su richiesta 2700K 2700K on request | | | | *su richiesta IP44 dimmerabile Triac dimmmable Triac IP44 on request | | |



| Codice Code | Materiale Material | Colore Colour | Sorgente luminosa Light source | Dimmerabile Dimmable | Classe energetica Energy label | Prezzo Retail con IVA Retail Price VAT incl. |
|----------------|--------------------------------|---|--|--|-----------------------------------|---|
| OORT00040 | Vetro, Metallo Glass, Metal |  Bianco, Specchio White, Mirror | LED 8W + 12W + 16W (3000K, 3400Lm) | Si, 1-10V/PUSH Yes, 1-10V/PUSH | G | 1.240,00 € |
| OORT00041 | Vetro, Metallo Glass, Metal |  Bianco, Specchio White, Mirror | LED 8W + 12W + 16W (DTW da 1800K a 4000K) | Si, 1-10V/PUSH Yes, 1-10V/PUSH | G | 1.330,00 € |
| | | | LED integrato Integrated LED |  IP20 | | |
| | | | Su richiedi 2700K 2700K on request | | | |

PALLINA FONTANAARTE DESIGN LAB 2019

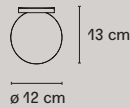

| Codice Code | Materiale Material | Colore Colour | Sorgente luminosa Light source | Dimmerabile Dimmable | Classe energetica Energy label | Prezzo Retail con IVA Retail Price VAT incl. |
|----------------|--|---|-----------------------------------|-------------------------|---|---|
| F443060150NENE | Vetro, Metallo Galvanizzato Glass, Galvanized Metal |  Nero lucido Glossy black | 1x max 6W G9 | Si Yes | Vedi tabella p. 181 See table p. 181 | 275,00 € |
| F443060150NSNE | Vetro, Metallo Galvanizzato Glass, Galvanized Metal |  Nichel lucido Glossy nickel | 1x max 6W G9 | Si Yes | Vedi tabella p. 181 See table p. 181 | 275,00 € |
| F443060150OTNE | Vetro, Metallo Galvanizzato Glass, Galvanized Metal |  Ottone lucido Glossy brass | 1x max 6W G9 | Si Yes | Vedi tabella p. 181 See table p. 181 | 275,00 € |
| F443060150ORNE | Vetro, Metallo Verniciato Glass, Painted Metal |  Oro rosa Rose gold | 1x max 6W G9 | Si Yes | Vedi tabella p. 181 See table p. 181 | 300,00 € |



PANGEN
HISTORICAL ARCHIVE
1969

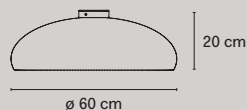

| Codice Code | Materiale Material | Colore Colour | Sorgente luminosa Light source | Dimmerabile Dimmable | Classe energetica Energy label | Prezzo Retail con IVA Retail Price VAT incl. |
|----------------|----------------------------------|---------------|--------------------------------|----------------------|--------------------------------------|--|
| F419766350BINE | Polimero, Metallo Polymer, Metal | Bianco White | 3x max 46W E27 | Si Yes | Vedi tabella p. 181 See table p. 181 | 820,00 € |
| F419766350NENE | Polimero, Metallo Polymer, Metal | Nero Black | 3x max 46W E27 | Si Yes | Vedi tabella p. 181 See table p. 181 | 820,00 € |
| F419766350RONE | Polimero, Metallo Polymer, Metal | Rosso red | 3x max 46W E27 | Si Yes | Vedi tabella p. 181 See table p. 181 | 820,00 € |

CE ENEC IP20

SILLABA
PIERO CASTIGLIONI
1988

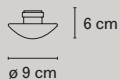

| Codice Code | Materiale Material | Colore Colour | Sorgente luminosa Light source | Dimmerabile Dimmable | Classe energetica Energy label | Prezzo Retail con IVA Retail Price VAT incl. |
|----------------|-----------------------------|---------------|--------------------------------|----------------------|--------------------------------------|--|
| F277560150BINE | Vetro, Metallo Glass, Metal | Bianco White | 1x max 20W G4 | Si Yes | Vedi tabella p. 181 See table p. 181 | 130,00 € |

CE ENEC IP44

Alimentatore non
incluso
Ballast not included

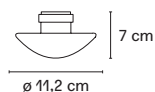

| Codice Code | Materiale Material | Colore Colour | Sorgente luminosa Light source | Dimmerabile Dimmable | Classe energetica Energy label | Prezzo Retail con IVA Retail Price VAT incl. |
|----------------|-----------------------------|---------------|--------------------------------|----------------------|--------------------------------------|--|
| F277565150BINE | Vetro, Metallo Glass, Metal | Bianco White | 1x max 50W GY6.35 | Si Yes | Vedi tabella p. 181 See table p. 181 | 200,00 € |

CE ENEC IP44

Alimentatore non
incluso
Ballast not included

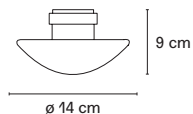

| Codice Code | Materiale Material | Colore Colour | Sorgente luminosa Light source | Dimmerabile Dimmable | Classe energetica Energy label | Prezzo Retail con IVA Retail Price VAT incl. |
|----------------|---------------------------------|-------------------|--------------------------------|----------------------|---|--|
| F277570150BINE | Vetro, Metallo Glass, Metall | ○ Bianco White | 1x max 60W G9 | Si Yes | Vedi tabella p. 181 See table p. 181 | 215,00 € |



| Codice Code | Materiale Material | Colore Colour | Sorgente luminosa Light source | Dimmerabile Dimmable | Classe energetica Energy label | Prezzo Retail con IVA Retail Price VAT incl. |
|----------------|---------------------------------|-------------------|------------------------------------|---|--------------------------------|--|
| F277570150BILE | Vetro, Metallo Glass, Metall | ○ Bianco White | LED 1x8W (3000K, CRI>80, 650Lm) | Si, a taglio di fase Yes, phase cut dimmer | F | 360,00 € |

LED integrato
Integrated LED



SILLABONE PIERO CASTIGLIONI 1988

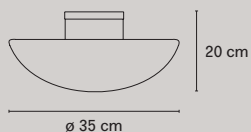

| Codice Code | Materiale Material | Colore Colour | Sorgente luminosa Light source | Dimmerabile Dimmable | Classe energetica Energy label | Prezzo Retail con IVA Retail Price VAT incl. |
|----------------|---------------------------------|-------------------|--------------------------------|----------------------|---|--|
| F279370150BINE | Vetro, Metallo Glass, Metall | ○ Bianco White | 1x max 100W E27 | Si Yes | Vedi tabella p. 181 See table p. 181 | 410,00 € |



SOLE BERNARDINO AMATO 2011

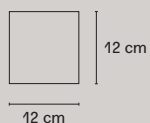

| Codice Code | Materiale Material | Colore Colour | Sorgente luminosa Light source | Dimmerabile Dimmable | Classe energetica Energy label | Prezzo Retail con IVA Retail Price VAT incl. |
|----------------|-----------------------------------|-------------------|-------------------------------------|-------------------------|--------------------------------|--|
| F414040150BILE | Vetro, Polimero Glass, Polymer | ○ Bianco White | LED 49x9W (3000K, CRI>85, 800Lm) | Si, TRIAC Yes, TRIAC | D | 375,00 € |

LED integrato
Integrated LED



| Codice Code | Materiale Material | Colore Colour | Sorgente luminosa Light source | Dimmerabile Dimmable | Classe energetica Energy label | Prezzo Retail con IVA Retail Price VAT incl. |
|-------------------------------------|-----------------------------------|-------------------|-------------------------------------|-------------------------|--------------------------------|--|
| F413940150BILE | Vetro, Polimero Glass, Polymer | ○ Bianco White | LED 49x9W (3000K, CRI>85, 800Lm) | Si, TRIAC Yes, TRIAC | D | 2.050,00 € |
| Confezione da 6 pz Pack of 6 pcs | | | LED integrato Integrated LED | CE ENEC Intertek | Classe # IP44 | |

THEA
GABRIELE E OSCAR BURATTI
2022

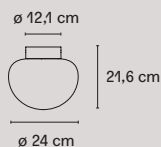

| Codice Code | Materiale Material | Colore Colour | Sorgente luminosa Light source | Dimmerabile Dimmable | Classe energetica Energy label | Prezzo Retail con IVA Retail Price VAT incl. |
|-------------------------------|--|--|-------------------------------------|-------------------------|--------------------------------|--|
| F444965550NFLE | Vetro, Metallo Galvanizzato Glass, Galvanized Metal | ● Nero lucido, Fumè Glossy black, Grey fumè | LED 3,85W (3000K, CRI>90, 640Lm) | Si, TRIAC Yes, TRIAC | F | 920,00 € |
| F444965575RTLE | Vetro, Metallo Galvanizzato Glass, Galvanized Metal | ● Rame lucido, Trasparente Glossy copper, Transparent | LED 3,85W (3000K, CRI>90, 640Lm) | Si, TRIAC Yes, TRIAC | F | 920,00 € |
| VETRO SOFFIATO BLOWN GLASS | | | LED integrato Integrated LED | CE IP40 | | |

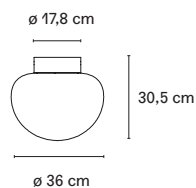

| Codice Code | Materiale Material | Colore Colour | Sorgente luminosa Light source | Dimmerabile Dimmable | Classe energetica Energy label | Prezzo Retail con IVA Retail Price VAT incl. |
|-------------------------------|--|--|--------------------------------------|-----------------------------------|--------------------------------|--|
| F444970550NFLE | Vetro, Metallo Galvanizzato Glass, Galvanized Metal | ● Nero lucido, Fumè Glossy black, Grey fumè | LED 11,6W (3000K, CRI>90, 1596Lm) | Si, 1-10V/PUSH Yes, 1-10V/PUSH | F | 1.540,00 € |
| F444970575RTLE | Vetro, Metallo Galvanizzato Glass, Galvanized Metal | ● Rame lucido, Trasparente Glossy copper, Transparent | LED 11,6W (3000K, CRI>90, 1596Lm) | Si, 1-10V/PUSH Yes, 1-10V/PUSH | F | 1.540,00 € |
| VETRO SOFFIATO BLOWN GLASS | | | LED integrato Integrated LED | CE IP40 | | |

TROPICO
GABRIELE E OSCAR BURATTI
2020

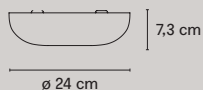

| Codice Code | Materiale Material | Colore Colour | Sorgente luminosa Light source | Dimmerabile Dimmable | Classe energetica Energy label | Prezzo Retail con IVA Retail Price VAT incl. |
|----------------|---|-------------------------------|--------------------------------------|---|--------------------------------|--|
| F442160550NELE | Vetro, Metallo Galvanizzato Glass, Galvanized Metall | ● Nero lucido Glossy black | LED 20,5W (3000K, CRI>80, 2200Lm) | Si, a taglio di fase Yes, phase cut dimmer | F | 470,00 € |
| F442160550OOLE | Vetro, Metallo Galvanizzato Glass, Galvanized Metal | ● Oro lucido Glossy gold | LED 20,5W (3000K, CRI>80, 2200Lm) | Si, a taglio di fase Yes, phase cut dimmer | F | 470,00 € |
| | | | LED integrato Integrated LED | CE | IP20 | |

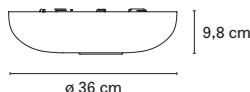

| Codice Code | Materiale Material | Colore Colour | Sorgente luminosa Light source | Dimmerabile Dimmable | Classe energetica Energy label | Prezzo Retail con IVA Retail Price VAT incl. |
|----------------|---|-------------------------------|--------------------------------------|---|--------------------------------|--|
| F442165550NELE | Vetro, Metallo Galvanizzato Glass, Galvanized Metall | ● Nero lucido Glossy black | LED 30,5W (3000K, CRI>80, 3000Lm) | Si, a taglio di fase Yes, phase cut dimmer | E | 590,00 € |
| F442165550OOLE | Vetro, Metallo Galvanizzato Glass, Galvanized Metal | ● Oro lucido Glossy gold | LED 30,5W (3000K, CRI>80, 3000Lm) | Si, a taglio di fase Yes, phase cut dimmer | E | 590,00 € |
| | | | LED integrato Integrated LED | CE | IP20 | |

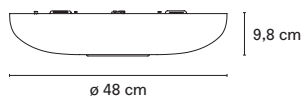

| Codice Code | Materiale Material | Colore Colour | Sorgente luminosa Light source | Dimmerabile Dimmable | Classe energetica Energy label | Prezzo Retail con IVA Retail Price VAT incl. |
|----------------|---|-------------------------------|--------------------------------------|---|--------------------------------|--|
| F442170550NELE | Vetro, Metallo Galvanizzato Glass, Galvanized Metall | ● Nero lucido Glossy black | LED 42,5W (3000K, CRI>80, 4600Lm) | Si, a taglio di fase Yes, phase cut dimmer | F | 780,00 € |
| F442170550OOLE | Vetro, Metallo Galvanizzato Glass, Galvanized Metal | ● Oro lucido Glossy gold | LED 42,5W (3000K, CRI>80, 4600Lm) | Si, a taglio di fase Yes, phase cut dimmer | F | 780,00 € |
| | | | LED integrato Integrated LED | CE | IP20 | |

KIT CASAMBI
R442100K05BI00

Casambi è un dispositivo intelligente, non è necessaria una connessione Internet ma è sufficiente attivare il Bluetooth del telefono o tablet o altri dispositivi di controllo e scaricare la App gratuita grazie alla quale le lampade potranno venire accese, spente e regolate di intensità a seconda dello scenario che si desidera nel proprio ambiente.

Casambi is an intelligent device, no Internet connection is required, simply activate the Bluetooth on your phone, tablet or other control device and download the free App to turn the lamps on and off and adjust their intensity according to the scenario you want to create in your environment.

165,00 €

LAMPADE A SOSPENSIONE / SUSPENSION LAMPS

| | | | |
|---------------|--------|------------|--------|
| 0024 | p. 95 | SERPENTINE | p. 120 |
| AMAX | p. 96 | SETAREH | p. 120 |
| AVICO | p. 98 | THEA | p. 125 |
| BIANCA | p. 99 | TUTTI | p. 126 |
| BOLLA | p. 100 | UOVO | p. 130 |
| CHANDELIER | p. 101 | | |
| CHESHIRE | p. 102 | | |
| EQUATORE | p. 103 | | |
| FONTANELLA | p. 104 | | |
| FLÛTE | p. 105 | | |
| GLOBO DI LUCE | p. 107 | | |
| HUNA | p. 109 | | |
| LAMPARA | p. 109 | | |
| MERIDIANO | p. 110 | | |
| OORT SISTEMA | p. 112 | | |
| PALLINA | p. 116 | | |
| PANGEN | p. 116 | | |
| PAROLA | p. 117 | | |
| PINECONE | p. 117 | | |
| SCINTILLA | p. 119 | | |

0024
GIO PONTI
1933

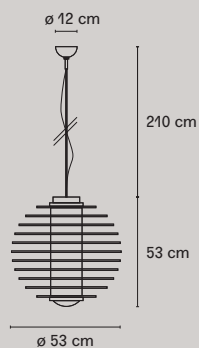

| Codice Code | Materiale Material | Colore Colour | Sorgente luminosa Light source | Dimmerabile Dimmable | Classe energetica Energy label | Prezzo Retail con IVA Retail Price VAT incl. |
|----------------|--------------------------------|----------------------------|--------------------------------|----------------------|---|--|
| F002485150TRNE | Vetro, Metallo Glass, Metal | Trasparente Transparent | 2x max 36W 2G11 | No | Vedi tabella p. 181 See table p. 181 | 2.550,00 € |

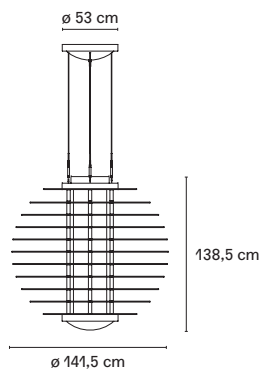

| Codice Code | Materiale Material | Colore Colour | Sorgente luminosa Light source | Dimmerabile Dimmable | Classe energetica Energy label | Prezzo Retail con IVA Retail Price VAT incl. |
|-------------|--------------------------------|----------------------------|--------------------------------|-----------------------|---|--|
| S0024..... | Vetro, Metallo Glass, Metal | Trasparente Transparent | 4x max 54W G5 | Sì, DALI Yes, DALI | Vedi tabella p. 181 See table p. 181 | SU RICHIESTA ON REQUEST |

Rosone e cavi, non
inclusi nel prezzo
Ceiling rose and cables,
not included in the price



AMAX
CHARLES WILLIAMS
2003

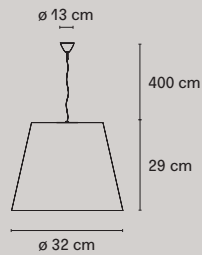

| Codice Code | Materiale Material | Colore Colour | Sorgente luminosa Light source | Dimmerabile Dimmable | Classe energetica Energy label | Prezzo Retail con IVA Retail Price VAT incl. |
|----------------|-------------------------------------|-------------------|--------------------------------|----------------------|---|--|
| F544480350BINE | Polimero, Metallo Polymer, Metal | ○ Bianco White | 1x max 100W E27 | Si Yes | Vedi tabella p. 181 See table p. 181 | 490,00 € |

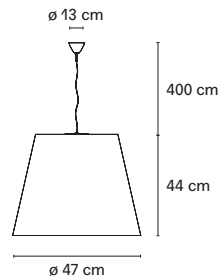

| Codice Code | Materiale Material | Colore Colour | Sorgente luminosa Light source | Dimmerabile Dimmable | Classe energetica Energy label | Prezzo Retail con IVA Retail Price VAT incl. |
|----------------|-------------------------------------|-------------------|--------------------------------|----------------------|---|--|
| F544485350BINE | Polimero, Metallo Polymer, Metal | ○ Bianco White | 1x max 150W E27 | Si Yes | Vedi tabella p. 181 See table p. 181 | 660,00 € |

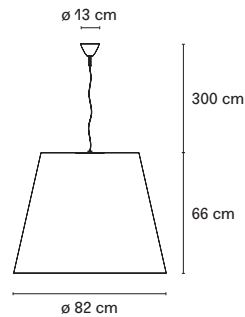

| Codice Code | Materiale Material | Colore Colour | Sorgente luminosa Light source | Dimmerabile Dimmable | Classe energetica Energy label | Prezzo Retail con IVA Retail Price VAT incl. |
|----------------|-------------------------------------|-------------------|--------------------------------|----------------------|---|--|
| F544490350BINE | Polimero, Metallo Polymer, Metal | ○ Bianco White | 3x max 100W E27 | Si Yes | Vedi tabella p. 181 See table p. 181 | 1.100,00 € |



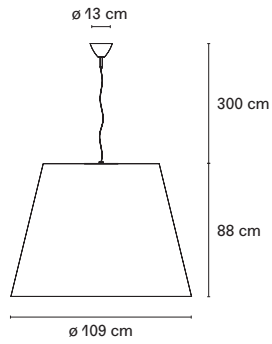

| Codice Code | Materiale Material | Colore Colour | Sorgente luminosa Light source | Dimmerabile Dimmable | Classe energetica Energy label | Prezzo Retail con IVA Retail Price VAT incl. |
|----------------|-------------------------------------|-------------------|--------------------------------|----------------------|---|--|
| F544495350BINE | Polimero, Metallo Polymer, Metal | ○ Bianco White | 3x max 150W E27 | Si Yes | Vedi tabella p. 181 See table p. 181 | 1.600,00 € |

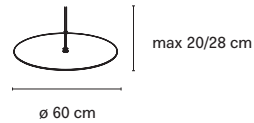

| Codice Code | Materiale Material | Colore Colour | Descrizione Description | Prezzo Retail con IVA Retail Price VAT incl. |
|----------------|--------------------------------------|----------------------------------|---|--|
| R556201K00CB00 | Polimero, Metallo Polymer, Metall | ◐ Cromo, Bianco Chrome, White | Disco di chiusura con tige telescopica per F544490350BINE Closing disk with telescopic stem for F544490350BINE | 445,00 € |

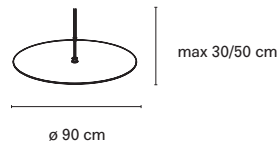

| Codice Code | Materiale Material | Colore Colour | Descrizione Description | Prezzo Retail con IVA Retail Price VAT incl. |
|----------------|--------------------------------------|----------------------------------|---|--|
| R556200K00CB00 | Polimero, Metallo Polymer, Metall | ◐ Cromo, Bianco Chrome, White | Disco di chiusura con tige telescopica per F544495350BINE Closing disk with telescopic stem for F544495350BINE | 545,00 € |

AVICO
CHARLES WILLIAMS
2006

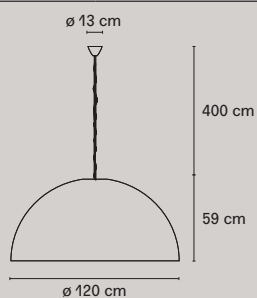

| Codice Code | Materiale Material | Colore Colour | Sorgente luminosa Light source | Dimmerabile Dimmable | Classe energetica Energy label | Prezzo Retail con IVA Retail Price VAT incl. |
|----------------|-------------------------------------|-------------------|--------------------------------|----------------------|---|--|
| F556180350BINE | Polimero, Metallo Polymer, Metal | ○ Bianco White | 3x max 100W E27 | Si Yes | Vedi tabella p. 181 See table p. 181 | 1.460,00 € |
| F556180375NENE | Polimero, Metallo Polymer, Metal | ● Nero Black | 3x max 100W E27 | Si Yes | Vedi tabella p. 181 See table p. 181 | 2.650,00 € |

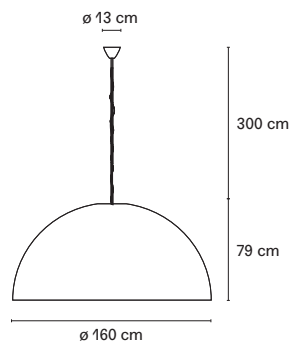

| Codice Code | Materiale Material | Colore Colour | Sorgente luminosa Light source | Dimmerabile Dimmable | Classe energetica Energy label | Prezzo Retail con IVA Retail Price VAT incl. |
|----------------|-------------------------------------|-------------------|--------------------------------|----------------------|---|--|
| F556185350BINE | Polimero, Metallo Polymer, Metal | ○ Bianco White | 3x max 150W E27 | Si Yes | Vedi tabella p. 181 See table p. 181 | 2.150,00 € |
| F556185375NENE | Polimero, Metallo Polymer, Metal | ● Nero Black | 3x max 150W E27 | Si Yes | Vedi tabella p. 181 See table p. 181 | 3.700,00 € |

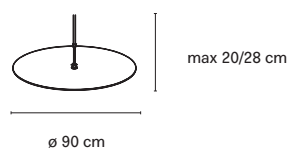

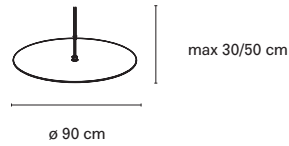

| Codice Code | Materiale Material | Colore Colour | Descrizione Description | Prezzo Retail con IVA Retail Price VAT incl. |
|----------------|--------------------------------------|----------------------------------|---|--|
| R556203K00CB00 | Polimero, Metallo Polymer, Metall | ◐ Cromo, Bianco Chrome, White | Disco di chiusura con tige telescopica per F556185350BINE e F556185375NENE Closing disk with telescopic stem for F556185350BINE and F556185375NENE | 545,00 € |



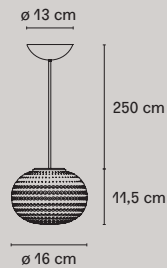

| Codice Code | Materiale Material | Colore Colour | Descrizione Description | Prezzo Retail con IVA Retail Price VAT incl. |
|----------------|--------------------------------------|--|---|--|
| R556200K00CB00 | Polimero, Metallo Polymer, Metall |  Cromo, Bianco Chrome, White | Disco di chiusura con tige telescopica per F556185350BINE e F556185375NENE Closing disk with telescopic stem for F556185350BINE and F556185375NENE | 545,00 € |

BIANCA MATTI KLENELL 2015

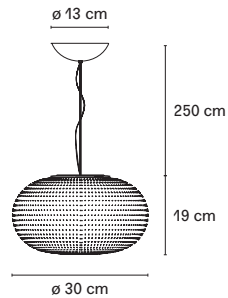

| Codice Code | Materiale Material | Colore Colour | Sorgente luminosa Light source | Dimmerabile Dimmable | Classe energetica Energy label | Prezzo Retail con IVA Retail Price VAT incl. |
|----------------|--------------------------------|---|------------------------------------|---|--------------------------------|--|
| F430680150BILE | Vetro, Metallo Glass, Metal |  Bianco White | LED 4,5W (2700K, CRI>80, 350Lm) | Sì, a taglio di fase Yes, phase cut dimmer | F | 370,00 € |
| | | | LED integrato Integrated LED |  | | |



| Codice Code | Materiale Material | Colore Colour | Sorgente luminosa Light source | Dimmerabile Dimmable | Classe energetica Energy label | Prezzo Retail con IVA Retail Price VAT incl. |
|----------------|--------------------------------|---|--------------------------------------|---|--------------------------------|--|
| F430685150BILE | Vetro, Metallo Glass, Metal |  Bianco White | LED 17,5W (2700K, CRI>80, 1650Lm) | Sì, TRIAC Yes, TRIAC | E | 550,00 € |
| | | | LED integrato Integrated LED |  | | |



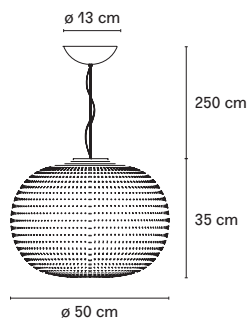

| Codice Code | Materiale Material | Colore Colour | Sorgente luminosa Light source | Dimmerabile Dimmable | Classe energetica Energy label | Prezzo Retail con IVA Retail Price VAT incl. |
|----------------|-----------------------------|----------------|--------------------------------|----------------------|--------------------------------------|--|
| F430690150BINE | Vetro, Metallo Glass, Metal | ○ Bianco White | 1x max 116W E27 | Si Yes | Vedi tabella p. 181 See table p. 181 | 770,00 € |



CE ENEC IP20

BOLLA STUDIO HARRY-PAUL 2003

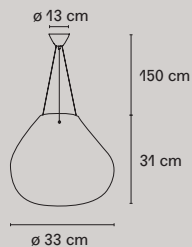

| Codice Code | Materiale Material | Colore Colour | Sorgente luminosa Light source | Dimmerabile Dimmable | Classe energetica Energy label | Prezzo Retail con IVA Retail Price VAT incl. |
|----------------|--------------------|---------------------------|--------------------------------|----------------------|--------------------------------------|--|
| F354085100TRNE | Vetro, Glass | ○ Trasparente Transparent | 1x max 77W E27 | Si Yes | Vedi tabella p. 181 See table p. 181 | 740,00 € |



CE ENEC IP20

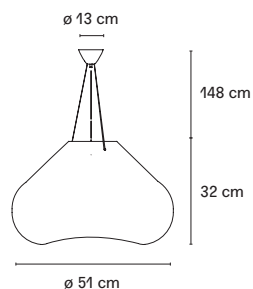

| Codice Code | Materiale Material | Colore Colour | Sorgente luminosa Light source | Dimmerabile Dimmable | Classe energetica Energy label | Prezzo Retail con IVA Retail Price VAT incl. |
|----------------|--------------------|---------------------------|--------------------------------|----------------------|--------------------------------------|--|
| F354090100TRNE | Vetro, Glass | ○ Trasparente Transparent | 1x max 77W E27 | Si Yes | Vedi tabella p. 181 See table p. 181 | 890,00 € |



CE ENEC IP20

CHANDELIER
DAVID CHIPPERFIELD
2004

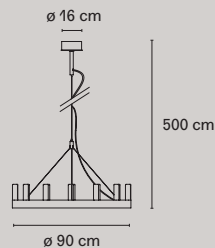

| Codice Code | Materiale Material | Colore Colour | Sorgente luminosa Light source | Dimmerabile Dimmable | Classe energetica Energy label | Prezzo Retail con IVA Retail Price VAT incl. |
|----------------|---|-----------------------------|--------------------------------|----------------------|--------------------------------------|--|
| F549180250NBNE | Metallo Verniciato, Vetro Painted Metal, Glas | ● Nero, Bianco Black, White | 14x max 40W E14 | Si Yes | Vedi tabella p. 181 See table p. 181 | 3.550,00 € |
| F549180260OBNE | Metallo Verniciato, Vetro Painted Metal, Glas | ● Oro, Bianco Glod, White | 14x max 40W E14 | Si Yes | Vedi tabella p. 181 See table p. 181 | 3.750,00 € |

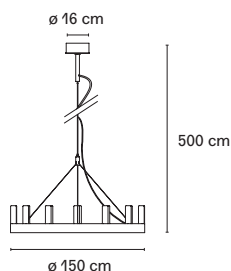

| Codice Code | Materiale Material | Colore Colour | Sorgente luminosa Light source | Dimmerabile Dimmable | Classe energetica Energy label | Prezzo Retail con IVA Retail Price VAT incl. |
|----------------|---|-----------------------------|--------------------------------|----------------------|--------------------------------------|--|
| F549185250NBNE | Metallo Verniciato, Vetro Painted Metal, Glas | ● Nero, Bianco Black, White | 19x max 40W E14 | Si Yes | Vedi tabella p. 181 See table p. 181 | 4.700,00 € |
| F549185260OBNE | Metallo Verniciato, Vetro Painted Metal, Glas | ● Oro, Bianco Glod, White | 19x max 40W E14 | Si Yes | Vedi tabella p. 181 See table p. 181 | 4.850,00 € |

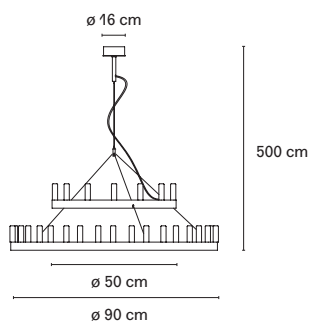

| Codice Code | Materiale Material | Colore Colour | Sorgente luminosa Light source | Dimmerabile Dimmable | Classe energetica Energy label | Prezzo Retail con IVA Retail Price VAT incl. |
|----------------|---|-----------------------------|----------------------------------|----------------------|--------------------------------------|--|
| F549190250NBNE | Metallo Verniciato, Vetro Painted Metal, Glas | ● Nero, Bianco Black, White | 8x max 40W E14 + 14x max 40W E14 | Si Yes | Vedi tabella p. 181 See table p. 181 | 5.700,00 € |
| F549190260OBNE | Metallo Verniciato, Vetro Painted Metal, Glas | ● Oro, Bianco Glod, White | 8x max 40W E14 + 14x max 40W E14 | Si Yes | Vedi tabella p. 181 See table p. 181 | 6.050,00 € |



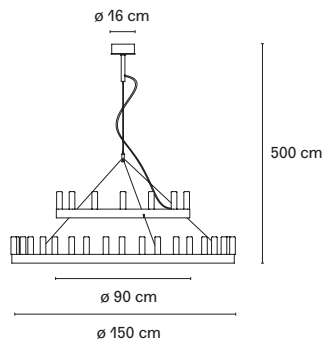

| Codice Code | Materiale Material | Colore Colour | Sorgente luminosa Light source | Dimmerabile Dimmable | Classe energetica Energy label | Prezzo Retail con IVA Retail Price VAT incl. |
|----------------|---|-----------------------------|--------------------------------------|----------------------|---|--|
| F549195250NBNE | Metallo Verniciato, Vetro Painted Metal, Glas | ● Nero, Bianco Black, White | 14x max 40W E14 + 19x max 40W E14 | Si Yes | Vedi tabella p. 181 See table p. 181 | 7.600,00 € |
| F549190260OBNE | Metallo Verniciato, Vetro Painted Metal, Glas | ● Oro, Bianco Glod, White | 14x max 40W E14 + 19x max 40W E14 | Si Yes | Vedi tabella p. 181 See table p. 181 | 8.100,00 € |



CHESHIRE GAMFRATESI 2013

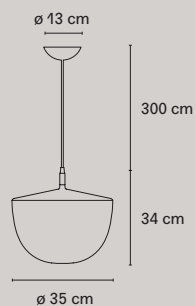





| Codice Code | Materiale Material | Colore Colour | Sorgente luminosa Light source | Dimmerabile Dimmable | Classe energetica Energy label | Prezzo Retail con IVA Retail Price VAT incl. |
|----------------|--------------------|----------------|--------------------------------|----------------------|---|--|
| F425785350BINE | Polimero Polymer | ○ Bianco White | 3x max 23W E27 | Si Yes | Vedi tabella p. 181 See table p. 181 | 520,00 € |
| F425785350NENE | Polimero Polymer | ● Nero Black | 3x max 23W E27 | Si Yes | Vedi tabella p. 181 See table p. 181 | 520,00 € |

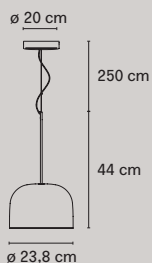

EQUATORE
GABRIELE E OSCAR BURATTI
2017



| Codice Code | Materiale Material | Colore Colour | Sorgente luminosa Light source | Dimmerabile Dimmable | Classe energetica Energy label | Prezzo Retail con IVA Retail Price VAT incl. |
|----------------|---|---|---------------------------------|----------------------|--------------------------------|--|
| F439080550CRLE | Vetro, Metallo Galvanizzato Glass, Galvanized Metal |  Cromo Chrome | LED 25W (2700K, CRI>90, 2900Lm) | Si, 1-10V Yes, 1-10V | F | 1.380,00 € |
| F439080550NELE | Vetro, Metallo Galvanizzato Glass, Galvanized Metal |  Nero lucido Glossy black | LED 25W (2700K, CRI>90, 2900Lm) | Si, 1-10V Yes, 1-10V | F | 1.380,00 € |
| F439080150OOLE | Vetro, Metallo Glass, Metal |  Oro opaco Matt gold | LED 25W (2700K, CRI>90, 2900Lm) | Si, 1-10V Yes, 1-10V | F | 1.180,00 € |
| F439080550RSLE | Vetro, Metallo Galvanizzato Glass, Galvanized Metal |  Rame lucido Glossy copper | LED 25W (2700K, CRI>90, 2900Lm) | Si, 1-10V Yes, 1-10V | F | 1.380,00 € |







LED integrato
Integrated LED

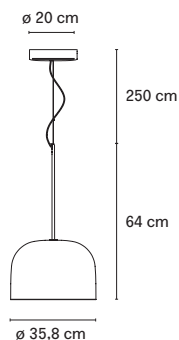

Su richiesta tecnologia
Dali o Casambi
Dali or Casambi
technology on request



| Codice Code | Materiale Material | Colore Colour | Sorgente luminosa Light source | Dimmerabile Dimmable | Classe energetica Energy label | Prezzo Retail con IVA Retail Price VAT incl. |
|----------------|---|---|---------------------------------|----------------------|--------------------------------|--|
| F439085550CRLE | Vetro, Metallo Galvanizzato Glass, Galvanized Metal |  Cromo Chrome | LED 40W (2700K, CRI>90, 4500Lm) | Si, 1-10V Yes, 1-10V | F | 1.860,00 € |
| F439085550NELE | Vetro, Metallo Galvanizzato Glass, Galvanized Metal |  Nero lucido Glossy black | LED 40W (2700K, CRI>90, 4500Lm) | Si, 1-10V Yes, 1-10V | F | 1.860,00 € |
| F439085150OOLE | Vetro, Metallo Glass, Metal |  Oro opaco Matt gold | LED 40W (2700K, CRI>90, 4500Lm) | Si, 1-10V Yes, 1-10V | F | 1.700,00 € |
| F439085550RSLE | Vetro, Metallo Galvanizzato Glass, Galvanized Metal |  Rame lucido Glossy copper | LED 40W (2700K, CRI>90, 4500Lm) | Si, 1-10V Yes, 1-10V | F | 1.860,00 € |







LED integrato
Integrated LED

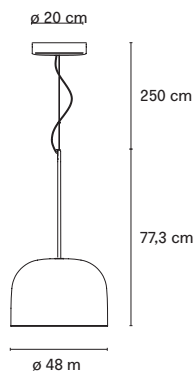

Su richiesta tecnologia
Dali o Casambi
Dali or Casambi
technology on request



| Codice Code | Materiale Material | Colore Colour | Sorgente luminosa Light source | Dimmerabile Dimmable | Classe energetica Energy label | Prezzo Retail con IVA Retail Price VAT incl. |
|----------------|--|--|------------------------------------|-------------------------|--------------------------------|--|
| F439090550CRLE | Vetro, Metallo Galvanizzato Glass, Galvanized Metal |  Cromo Chrome | LED 60W (2700K, CRI>90, 6600Lm) | Si, 1-10V Yes, 1-10V | F | 3.450,00 € |
| F439090550NELE | Vetro, Metallo Galvanizzato Glass, Galvanized Metal |  Nero lucido Glossy black | LED 60W (2700K, CRI>90, 6600Lm) | Si, 1-10V Yes, 1-10V | F | 3.450,00 € |
| F439090150OOLE | Vetro, Metallo Glass, Metal |  Oro opaco Matt gold | LED 60W (2700K, CRI>90, 6600Lm) | Si, 1-10V Yes, 1-10V | F | 3.380,00 € |
| F439090550RSLE | Vetro, Metallo Galvanizzato Glass, Galvanized Metal |  Rame lucido Glossy copper | LED 60W (2700K, CRI>90, 6600Lm) | Si, 1-10V Yes, 1-10V | F | 3.450,00 € |







LED integrato
Integrated LED

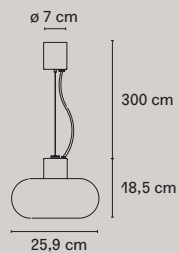

Su richiesta tecnologia
Dali o Casambi
Dali or Casambi
technology on request



FONTANELLA FEDERICO PERI 2020



| Codice Code | Materiale Material | Colore Colour | Sorgente luminosa Light source | Dimmerabile Dimmable | Classe energetica Energy label | Prezzo Retail con IVA Retail Price VAT incl. |
|----------------|--|---|--------------------------------|----------------------|---|--|
| F447890550CRNE | Vetro, Metallo Galvanizzato Glass, Galvanized Metal |  Cromo Chrome | 1x max 28W E14 | Si Yes | Vedi tabella p. 181 See table p. 181 | 650,00 € |
| F447890550NENE | Vetro, Metallo Galvanizzato Glass, Galvanized Metal |  Nero lucido Glossy black | 1x max 28W E14 | Si Yes | Vedi tabella p. 181 See table p. 181 | 650,00 € |
| F447890550OTNE | Vetro, Metallo Galvanizzato Glass, Galvanized Metal |  Ottone lucido Glossy Brass | 1x max 28W E14 | Si Yes | Vedi tabella p. 181 See table p. 181 | 670,00 € |

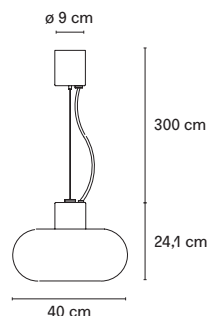







| Codice Code | Materiale Material | Colore Colour | Sorgente luminosa Light source | Dimmerabile Dimmable | Classe energetica Energy label | Prezzo Retail con IVA Retail Price VAT incl. |
|----------------|--|---|-----------------------------------|-------------------------|---|---|
| F447885550CRNE | Vetro, Metallo Galvanizzato Glass, Galvanized Metal |  Cromo Chrome | 1x max 77W E27 | Si Yes | Vedi tabella p. 181 See table p. 181 | 870,00 € |
| F447885550NENE | Vetro, Metallo Galvanizzato Glass, Galvanized Metal |  Nero lucido Glossy black | 1x max 77W E27 | Si Yes | Vedi tabella p. 181 See table p. 181 | 870,00 € |
| F447885550OTNE | Vetro, Metallo Galvanizzato Glass, Galvanized Metal |  Ottone lucido Glossy Brass | 1x max 77W E27 | Si Yes | Vedi tabella p. 181 See table p. 181 | 890,00 € |

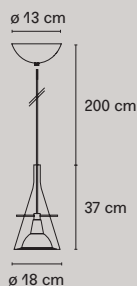



FLÛTE FRANCO RAGGI 1999



| Codice Code | Materiale Material | Colore Colour | Sorgente luminosa Light source | Dimmerabile Dimmable | Classe energetica Energy label | Prezzo Retail con IVA Retail Price VAT incl. |
|----------------|--|---|-----------------------------------|-------------------------|---|---|
| F333780150TCNE | Vetro, Metallo Glass, Metal |  Trasparente, Cromo Transparent, Chrome | 1x max 70W E27 | Si Yes | Vedi tabella p. 181 See table p. 181 | 570,00 € |
| F333780550NENE | Vetro, Metallo Galvanizzato Glass, Galvanized Metal |  Trasparente, Nero lucido Transparent, Glossy black | 1x max 70W E27 | Si Yes | Vedi tabella p. 181 See table p. 181 | 590,00 € |
| F333780550OTNE | Vetro, Metallo Galvanizzato Glass, Galvanized Metal |  Trasparente, Ottone Transparent, Brass | 1x max 70W E27 | Si Yes | Vedi tabella p. 181 See table p. 181 | 590,00 € |

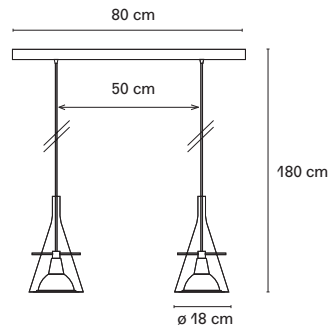





| Codice Code | Materiale Material | Colore Colour | Sorgente luminosa Light source | Dimmerabile Dimmable | Classe energetica Energy label | Prezzo Retail con IVA Retail Price VAT incl. |
|----------------|--------------------------------|---|--------------------------------|----------------------|---|--|
| F333785150TCNE | Vetro, Metallo Glass, Metal |  Trasparente, Cromo Transparent, Chrome | 2x max 70W E27 | Si Yes | Vedi tabella p. 181 See table p. 181 | 1.100,00 € |

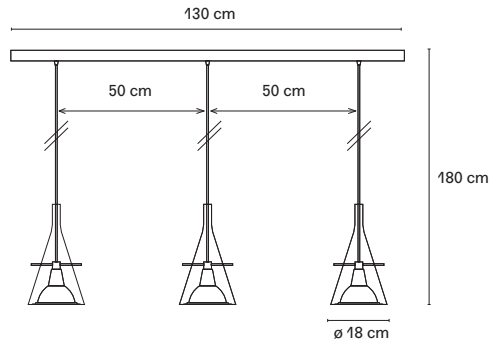

CE ENEC IP20





| Codice Code | Materiale Material | Colore Colour | Sorgente luminosa Light source | Dimmerabile Dimmable | Classe energetica Energy label | Prezzo Retail con IVA Retail Price VAT incl. |
|----------------|--------------------------------|---|--------------------------------|----------------------|---|--|
| F333790150TCNE | Vetro, Metallo Glass, Metal |  Trasparente, Cromo Transparent, Chrome | 3x max 70W E27 | Si Yes | Vedi tabella p. 181 See table p. 181 | 1.700,00 € |

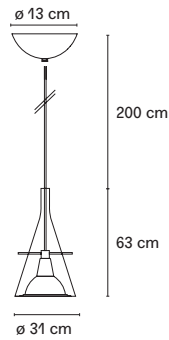

CE ENEC IP20





| Codice Code | Materiale Material | Colore Colour | Sorgente luminosa Light source | Dimmerabile Dimmable | Classe energetica Energy label | Prezzo Retail con IVA Retail Price VAT incl. |
|----------------|--------------------------------|---|-----------------------------------|-------------------------|---|---|
| F333795150TCNE | Vetro, Metallo Glass, Metal |  Trasparente, Cromo Transparent, Chrome | 1x max 230W R7s/115 | Si Yes | Vedi tabella p. 181 See table p. 181 | 1.550,00 € |

 VETRO SOFFIATO
BLOWN GLASS

CE EAC IP20

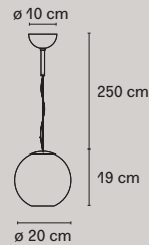
GLOBO DI LUCE
ROBERTO MENGHI
1968





| Codice Code | Materiale Material | Colore Colour | Sorgente luminosa Light source | Dimmerabile Dimmable | Classe energetica Energy label | Prezzo Retail con IVA Retail Price VAT incl. |
|----------------|--------------------------------|---|-----------------------------------|-------------------------|---|---|
| F364480150CRNE | Vetro, Metallo Glass, Metal |  Cromo Chrome | 1x max 40W E14 | Si Yes | Vedi tabella p. 181 See table p. 181 | 540,00 € |
| F364480150RMNE | Vetro, Metallo Glass, Metal |  Rame Copper | 1x max 40W E14 | Si Yes | Vedi tabella p. 181 See table p. 181 | 590,00 € |

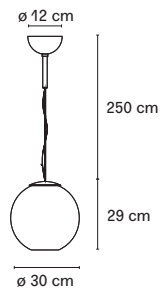

 VETRO SOFFIATO
BLOWN GLASS

CE EAC IP20

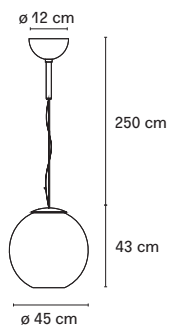

| Codice Code | Materiale Material | Colore Colour | Sorgente luminosa Light source | Dimmerabile Dimmable | Classe energetica Energy label | Prezzo Retail con IVA Retail Price VAT incl. |
|----------------|-----------------------------|---|--------------------------------|----------------------|---|--|
| F364485150CRNE | Vetro, Metallo Glass, Metal |  Cromo Chrome | 1x max 60W G9 | Si Yes | Vedi tabella p. 181 See table p. 181 | 720,00 € |
| F364485150RMNE | Vetro, Metallo Glass, Metal |  Rame Copper | 1x max 60W G9 | Si Yes | Vedi tabella p. 181 See table p. 181 | 820,00 € |





| Codice Code | Materiale Material | Colore Colour | Sorgente luminosa Light source | Dimmerabile Dimmable | Classe energetica Energy label | Prezzo Retail con IVA Retail Price VAT incl. |
|----------------|-----------------------------|---|--------------------------------|----------------------|---|--|
| F364490150CRNE | Vetro, Metallo Glass, Metal |  Cromo Chrome | 1x max 150W E27 | Si Yes | Vedi tabella p. 181 See table p. 181 | 1.050,00 € |
| F364490150RMNE | Vetro, Metallo Glass, Metal |  Rame Copper | 1x max 150W E27 | Si Yes | Vedi tabella p. 181 See table p. 181 | 1.200,00 € |

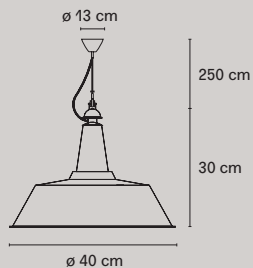

HUNA
HISTORICAL ARCHIVE
1965





| Codice Code | Materiale Material | Colore Colour | Sorgente luminosa Light source | Dimmerabile Dimmable | Classe energetica Energy label | Prezzo Retail con IVA Retail Price VAT incl. |
|----------------|-------------------------------------|---|-----------------------------------|-------------------------|---|---|
| F505985200ALNE | Metallo Verniciato Painted Metal |  Alluminio Aluminum | 1x max 116W E27 | Si Yes | Vedi tabella p. 181 See table p. 181 | 320,00 € |
| F505985200NENE | Metallo Verniciato Painted Metal |  Nero Black | 1x max 116W E27 | Si Yes | Vedi tabella p. 181 See table p. 181 | 320,00 € |

CE ENEC IP20

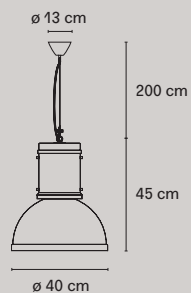
LAMPARA
HISTORICAL ARCHIVE
1965



| Codice Code | Materiale Material | Colore Colour | Sorgente luminosa Light source | Dimmerabile Dimmable | Classe energetica Energy label | Prezzo Retail con IVA Retail Price VAT incl. |
|----------------|-------------------------------------|---|-----------------------------------|-------------------------|---|---|
| F500090200ALNE | Metallo Verniciato Painted Metal |  Alluminio Aluminum | 1x max 116W E27 | Si Yes | Vedi tabella p. 181 See table p. 181 | 450,00 € |
| F500090220BINE | Metallo Verniciato Painted Metal |  Bianca White | 1x max 116W E27 | Si Yes | Vedi tabella p. 181 See table p. 181 | 595,00 € |

CE ENEC IP20

MERIDIANO



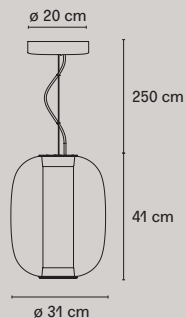

GABRIELE E OSCAR BURATTI

2020

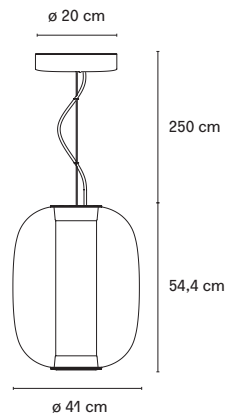

| Codice Code | Materiale Material | Colore Colour | Sorgente luminosa Light source | Dimmerabile Dimmable | Classe energetica Energy label | Prezzo Retail con IVA Retail Price VAT incl. |
|---|--|---|---|--|---|--|
| F441785550NFLE | Vetro, Metallo Galvanizzato Glass, Galvanized Metal |  Nero, Fumè Black, Grey fumè | LED 25W* (2700K, CRI>90, 2900Lm) + LED 8W ** (2700K, 1180Lm) | *Si, 1-10V Yes, 1-10V ** No | F | 1.830,00 € |
| F441785550NRLE | Vetro, Metallo Galvanizzato Glass, Galvanized Metal |  Nero, Rosa Black, Pink | LED 25W* (2700K, CRI>90, 2900Lm) + LED 8W ** (2700K, 1180Lm) | *Si, 1-10V Yes, 1-10V ** No | F | 1.830,00 € |
| F441785550NTLE | Vetro, Metallo Galvanizzato Glass, Galvanized Metal |  Nero, Trasparente Black, Transparent | LED 25W* (2700K, CRI>90, 2900Lm) + LED 8W ** (2700K, 1180Lm) | *Si, 1-10V Yes, 1-10V ** No | F | 1.830,00 € |
|  VETRO SOFFIATO BLOWN GLASS | | | LED integrato Integrated LED |  IP20 | Su richiesta tecnologia Dali o Casambi Dali or Casambi technology on request | |



| Codice Code | Materiale Material | Colore Colour | Sorgente luminosa Light source | Dimmerabile Dimmable | Classe energetica Energy label | Prezzo Retail con IVA Retail Price VAT incl. |
|---|--|---|---|--|--------------------------------|--|
| F441790550NFLE | Vetro, Metallo Galvanizzato Glass, Galvanized Metal |  Nero, Fumè Black, Grey fumè | LED 35W* (2700K, CRI>90, 4000Lm) + LED 8W** (2700K, 1180Lm) | *Si, 1-10V Yes, 1-10V ** No | F | 2.350,00 € |
| F441790550NRLE | Vetro, Metallo Galvanizzato Glass, Galvanized Metal |  Nero, Rosa Black, Pink | LED 35W* (2700K, CRI>90, 4000Lm) + LED 8W** (2700K, 1180Lm) | *Si, 1-10V Yes, 1-10V ** No | F | 2.350,00 € |
| F441790550NTLE | Vetro, Metallo Galvanizzato Glass, Galvanized Metal |  Nero, Trasparente Black, Transparent | LED 35W* (2700K, CRI>90, 4000Lm) + LED 8W** (2700K, 1180Lm) | *Si, 1-10V Yes, 1-10V ** No | F | 2.350,00 € |
|  VETRO SOFFIATO BLOWN GLASS | | | LED integrato Integrated LED |  IP20 | | |
| | | | Su richiesta tecnologia Dali o Casambi Dali or Casambi technology on request | | | |

OORT SISTEMA
JACOPO RODA
2022

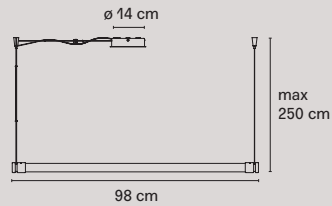

| Codice Code | Materiale Material | Colore Colour | Sorgente luminosa Light source | Dimmerabile Dimmable | Classe energetica Energy label | Prezzo Retail con IVA Retail Price VAT incl. |
|-------------|--|-------------------------------|-----------------------------------|-----------------------------------|--------------------------------|--|
| OORT00003 | Vetro, Metallo Galvanizzato Glass, Galvanized Metal | ● Nichel nero Nickel black | LED 18W (3000K, 1700Lm) | Si, 1-10V/PUSH Yes, 1-10V/PUSH | G | 700,00 € |
| OORT00012 | Vetro, Metallo Galvanizzato Glass, Galvanized Metal | ● Nichel nero Nickel black | LED 18W (DTW da 1800K a 4000K) | Si, 1-10V/PUSH Yes, 1-10V/PUSH | G | 760,00 € |

LED integrato
Integrated LED



Su richiesta tecnologia DALI
e 2700K
DALI technology and 2700K
on request

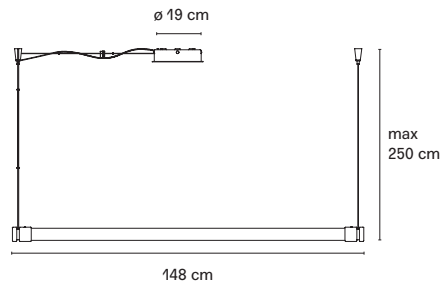

| Codice Code | Materiale Material | Colore Colour | Sorgente luminosa Light source | Dimmerabile Dimmable | Classe energetica Energy label | Prezzo Retail con IVA Retail Price VAT incl. |
|-------------|--|-------------------------------|-----------------------------------|-----------------------------------|--------------------------------|--|
| OORT00004 | Vetro, Metallo Galvanizzato Glass, Galvanized Metal | ● Nichel nero Nickel black | LED 28W (3000K, 2660Lm) | Si, 1-10V/PUSH Yes, 1-10V/PUSH | G | 830,00 € |
| OORT00013 | Vetro, Metallo Galvanizzato Glass, Galvanized Metal | ● Nichel nero Nickel black | LED 28W (DTW da 1800K a 4000K) | Si, 1-10V/PUSH Yes, 1-10V/PUSH | G | 910,00 € |

LED integrato
Integrated LED



Su richiesta tecnologia DALI
e 2700K
DALI technology and 2700K
on request

OORT SISTEMA
JACOPO RODA
2022

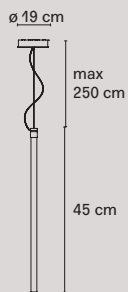

| Codice Code | Materiale Material | Colore Colour | Sorgente luminosa Light source | Dimmerabile Dimmable | Classe energetica Energy label | Prezzo Retail con IVA Retail Price VAT incl. |
|-------------|--|-------------------------------|----------------------------------|-----------------------------------|--------------------------------|--|
| OORT00005 | Vetro, Metallo Galvanizzato Glass, Galvanized Metal | ● Nichel nero Nickel black | LED 8W (3000K, 760Lm) | Si, 1-10V/PUSH Yes, 1-10V/PUSH | G | 530,00 € |
| OORT00014 | Vetro, Metallo Galvanizzato Glass, Galvanized Metal | ● Nichel nero Nickel black | LED 8W (DTW da 1800K a 4000K) | Si, 1-10V/PUSH Yes, 1-10V/PUSH | G | 580,00 € |

LED integrato
Integrated LED



Su richiesta tecnologia DALI
e 2700K
DALI technology and 2700K
on request

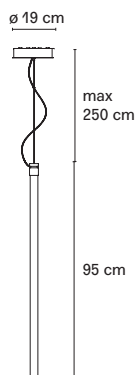

| Codice Code | Materiale Material | Colore Colour | Sorgente luminosa Light source | Dimmerabile Dimmable | Classe energetica Energy label | Prezzo Retail con IVA Retail Price VAT incl. |
|-------------|--|-------------------------------|-----------------------------------|-----------------------------------|--------------------------------|--|
| OORT00006 | Vetro, Metallo Galvanizzato Glass, Galvanized Metal | ● Nichel nero Nickel black | LED 18W (3000K, 1700Lm) | Si, 1-10V/PUSH Yes, 1-10V/PUSH | G | 620,00 € |
| OORT00015 | Vetro, Metallo Galvanizzato Glass, Galvanized Metal | ● Nichel nero Nickel black | LED 18W (DTW da 1800K a 4000K) | Si, 1-10V/PUSH Yes, 1-10V/PUSH | G | 680,00 € |

LED integrato
Integrated LED



Su richiesta tecnologia DALI
e 2700K
DALI technology and 2700K
on request

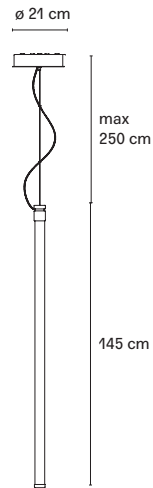

| Codice Code | Materiale Material | Colore Colour | Sorgente luminosa Light source | Dimmerabile Dimmable | Classe energetica Energy label | Prezzo Retail con IVA Retail Price VAT incl. |
|-------------|--|-------------------------------|-----------------------------------|---------------------------------|--------------------------------|--|
| OORT00007 | Vetro, Metallo Galvanizzato Glass, Galvanized Metal | ● Nichel nero Nickel black | LED 28W (3000K, 2660Lm) | Si, DALI/PUSH Yes, DALI/PUSH | G | 720,00 € |
| OORT00016 | Vetro, Metallo Galvanizzato Glass, Galvanized Metal | ● Nichel nero Nickel black | LED 28W (DTW da 1800K a 4000K) | Si, DALI/PUSH Yes, DALI/PUSH | G | 790,00 € |

LED integrato
Integrated LED

CE IP20

Su richiesta 2700K
2700K on request

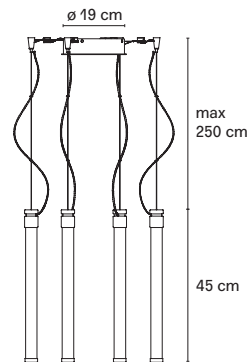

| Codice Code | Materiale Material | Colore Colour | Sorgente luminosa Light source | Dimmerabile Dimmable | Classe energetica Energy label | Prezzo Retail con IVA Retail Price VAT incl. |
|-------------|--|-------------------------------|------------------------------------|-----------------------------------|--------------------------------|--|
| OORT00008 | Vetro, Metallo Galvanizzato Glass, Galvanized Metal | ● Nichel nero Nickel black | LED 4x8W (3000K, 3040Lm) | Si, 1-10V/PUSH Yes, 1-10V/PUSH | G | 1.620,00 € |
| OORT00017 | Vetro, Metallo Galvanizzato Glass, Galvanized Metal | ● Nichel nero Nickel black | LED 4x8W (DTW da 1800K a 4000K) | Si, 1-10V/PUSH Yes, 1-10V/PUSH | G | 1.770,00 € |

LED integrato
Integrated LED

CE IP20

Su richiesta tecnologia DALI
e 2700K
DALI technology and 2700K
on request

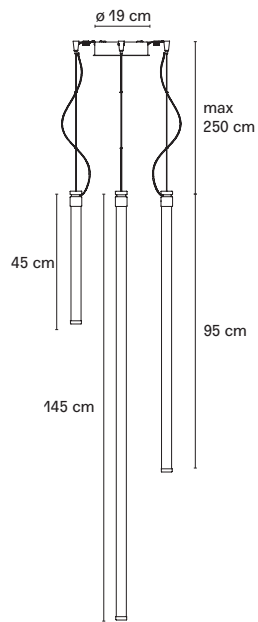

| Codice Code | Materiale Material | Colore Colour | Sorgente luminosa Light source | Dimmerabile Dimmable | Classe energetica Energy label | Prezzo Retail con IVA Retail Price VAT incl. |
|-------------|--|-------------------------------|--|-----------------------------------|--------------------------------|--|
| OORT00009 | Vetro, Metallo Galvanizzato Glass, Galvanized Metal | ● Nichel nero Nickel black | LED 8W + 18W + 28W (3000K, 5130Lm) | Si, 1-10V/PUSH Yes, 1-10V/PUSH | G | 1.540,00 € |
| OORT00018 | Vetro, Metallo Galvanizzato Glass, Galvanized Metal | ● Nichel nero Nickel black | LED 8W + 18W + 28W (DTW da 1800K a 4000K) | Si, 1-10V/PUSH Yes, 1-10V/PUSH | G | 1.680,00 € |

LED integrato
Integrated LED



Su richiesta tecnologia DALI
e 2700K
DALI technology and 2700K
on request



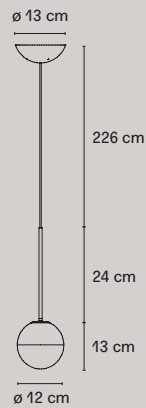

PALLINA
FONTANAARTE DESIGN LAB
2019



| Codice Code | Materiale Material | Colore Colour | Sorgente luminosa Light source | Dimmerabile Dimmable | Classe energetica Energy label | Prezzo Retail con IVA Retail Price VAT incl. |
|----------------|--|----------------------------------|--------------------------------|----------------------|---|--|
| F443080150NENE | Vetro, Metallo Galvanizzato Glass, Galvanized Metal | ● Nero lucido Glossy black | 1x max 6W G9 | Si Yes | Vedi tabella p. 181 See table p. 181 | 375,00 € |
| F443080150NSNE | Vetro, Metallo Galvanizzato Glass, Galvanized Metal | ● Nichel lucido Glossy nickel | 1x max 6W G9 | Si Yes | Vedi tabella p. 181 See table p. 181 | 375,00 € |
| F443080150OTNE | Vetro, Metallo Galvanizzato Glass, Galvanized Metal | ● Ottone lucido Glossy brass | 1x max 6W G9 | Si Yes | Vedi tabella p. 181 See table p. 181 | 375,00 € |
| F443080150ORNE | Vetro, Metallo Verniciato Glass, Painted Metal | ● Oro rosa Rose gold | 1x max 6W G9 | Si Yes | Vedi tabella p. 181 See table p. 181 | 385,00 € |

 VETRO SOFFIATO
 BLOWN GLASS

Con tige di 2 differenti misure
 Shaft 2 different sizes

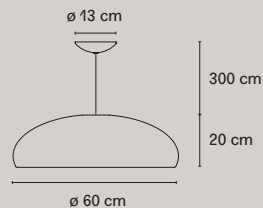

 Classe II
 IP20

PANGEN
HISTORICAL ARCHIVE
1969





| Codice Code | Materiale Material | Colore Colour | Sorgente luminosa Light source | Dimmerabile Dimmable | Classe energetica Energy label | Prezzo Retail con IVA Retail Price VAT incl. |
|----------------|-------------------------------------|-------------------|--------------------------------|----------------------|---|--|
| F419685350BINE | Polimero, Metallo Polymer, Metal | ○ Bianco White | 3x max 46W E27 | Si Yes | Vedi tabella p. 181 See table p. 181 | 835,00 € |
| F419685350NENE | Polimero, Metallo Polymer, Metal | ● Nero Black | 3x max 46W E27 | Si Yes | Vedi tabella p. 181 See table p. 181 | 835,00 € |
| F419685350RONE | Polimero, Metallo Polymer, Metal | ● Rosso Red | 3x max 46W E27 | Si Yes | Vedi tabella p. 181 See table p. 181 | 835,00 € |

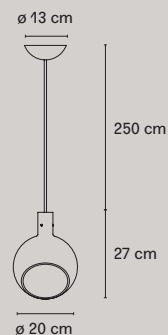

PAROLA
GAE AULENTI
E PIERO CASTIGLIONI
1980







| Codice Code | Materiale Material | Colore Colour | Sorgente luminosa Light source | Dimmerabile Dimmable | Classe energetica Energy label | Prezzo Retail con IVA Retail Price VAT incl. |
|----------------|--------------------|---|--------------------------------|----------------------|---|--|
| F428485100AMNE | Vetro Glass |  Ambra Amber | 1x max 3,5W G9 | Si Yes | Vedi tabella p. 181 See table p. 181 | 500,00 € |
| F428485100BINE | Vetro Glass |  Bianco White | 1x max 3,5W G9 | Si Yes | Vedi tabella p. 181 See table p. 181 | 500,00 € |

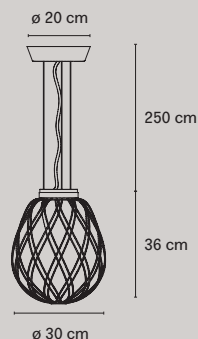

PINECONE
PAOLA NAVONE
2016



| Codice Code | Materiale Material | Colore Colour | Sorgente luminosa Light source | Dimmerabile Dimmable | Classe energetica Energy label | Prezzo Retail con IVA Retail Price VAT incl. |
|----------------|---|---|--------------------------------|----------------------|---|--|
| F436385550TCNE | Vetro, Metallo Galvanizzato Glass, Galvanized Metal |  Trasparente, Cromo Transparent, Chrome | 1x max 116W E27 | Si Yes | Vedi tabella p. 181 See table p. 181 | 1.790,00 € |
| F436385550CBNE | Vetro, Metallo Galvanizzato Glass, Galvanized Metal |  Bianco, Cromo White, Chrome | 1x max 116W E27 | Si Yes | Vedi tabella p. 181 See table p. 181 | 1.790,00 € |
| F436385575TONE | Vetro, Metallo Galvanizzato Glass, Galvanized Metal |  Trasparente, Oro Transparent, Gold | 1x max 116W E27 | Si Yes | Vedi tabella p. 181 See table p. 181 | 1.890,00 € |
| F436385575OBNE | Vetro, Metallo Galvanizzato Glass, Galvanized Metal |  Bianco, Oro White, Gold | 1x max 116W E27 | Si Yes | Vedi tabella p. 181 See table p. 181 | 1.890,00 € |



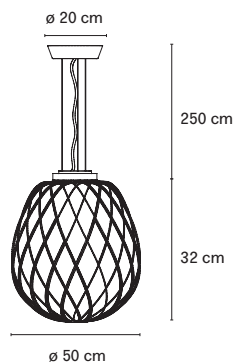

| Codice Code | Materiale Material | Colore Colour | Sorgente luminosa Light source | Dimmerabile Dimmable | Classe energetica Energy label | Prezzo Retail con IVA Retail Price VAT incl. |
|----------------|---|---|--------------------------------|----------------------|---|--|
| F433990550TCNE | Vetro, Metallo Galvanizzato Glass, Galvanized Metal | Trasparente, Cromo Transparent, Chrome | 1x max 116W E27 | Si Yes | Vedi tabella p. 181 See table p. 181 | 2.230,00 € |
| F433990550CBNE | Vetro, Metallo Galvanizzato Glass, Galvanized Metal | Bianco, Cromo White, Chrome | 1x max 116W E27 | Si Yes | Vedi tabella p. 181 See table p. 181 | 2.230,00 € |
| F433990575TONE | Vetro, Metallo Galvanizzato Glass, Galvanized Metal | Trasparente, Oro Transparent, Gold | 1x max 116W E27 | Si Yes | Vedi tabella p. 181 See table p. 181 | 2.600,00 € |
| F433990575OBNE | Vetro, Metallo Galvanizzato Glass, Galvanized Metal | Bianco, Oro White, Gold | 1x max 116W E27 | Si Yes | Vedi tabella p. 181 See table p. 181 | 2.600,00 € |

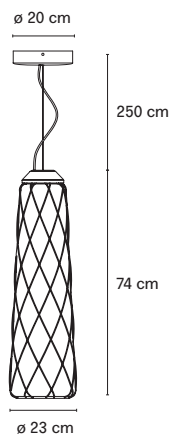

| Codice Code | Materiale Material | Colore Colour | Sorgente luminosa Light source | Dimmerabile Dimmable | Classe energetica Energy label | Prezzo Retail con IVA Retail Price VAT incl. |
|----------------|---|---|------------------------------------|---------------------------------------|--------------------------------|--|
| F446690550TCLE | Vetro, Metallo Galvanizzato Glass, Galvanized Metal | Trasparente, Cromo Transparent, Chrome | LED 17W (2700K, CRI>90, 2430Lm) | Si, 1-10V / PUSH Yes, 1-10V / PUSH | E | 2.800,00 € |
| F446690575TOLE | Vetro, Metallo Galvanizzato Glass, Galvanized Metal | Trasparente, Oro Transparent, Gold | LED 17W (2700K, CRI>90, 2430Lm) | Si, 1-10V / PUSH Yes, 1-10V / PUSH | E | 2.930,00 € |





LED integrato
Integrated LED



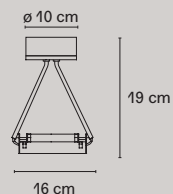

Su richiesta tecnologia DALI
DALI technology a on
request

SCINTILLA
LIVIO E PIERO CASTIGLIONI
1972

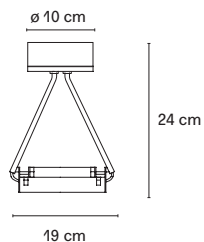

| Codice Code | Materiale Material | Colore Colour | Sorgente luminosa Light source | Dimmerabile Dimmable | Classe energetica Energy label | Prezzo Retail con IVA Retail Price VAT incl. |
|--|---------------------------------|---|-----------------------------------|-------------------------|---|---|
| FS15085250CRNE | Metallo, Vetro Metall, Glass |  Cromo Chrome | 1x max 120W R7s/80 | Si Yes | Vedi tabella p. 181 See table p. 181 | 310,00 € |
| FS15085250NSNE | Metallo, Vetro Metall, Glass |  Nichel satinato Satin nickel | 1x max 120W R7s/80 | Si Yes | Vedi tabella p. 181 See table p. 181 | 310,00 € |
| Compreso distanziatore Including spacer | | | | CE EAC IP20 | | |



| Codice Code | Materiale Material | Colore Colour | Sorgente luminosa Light source | Dimmerabile Dimmable | Classe energetica Energy label | Prezzo Retail con IVA Retail Price VAT incl. |
|--|---------------------------------|---|-----------------------------------|-------------------------|---|---|
| FS30090250CRNE | Metallo, Vetro Metall, Glass |  Cromo Chrome | 1x max 230W R7s/80 | Si Yes | Vedi tabella p. 181 See table p. 181 | 325,00 € |
| FS30090250NSNE | Metallo, Vetro Metall, Glass |  Nichel satinato Satin nickel | 1x max 230W R7s/80 | Si Yes | Vedi tabella p. 181 See table p. 181 | 325,00 € |
| Compreso distanziatore Including spacer | | | | CE EAC IP20 | | |

| Codice Code | Materiale Material | Colore Colour | Descrizione Description | Prezzo Retail con IVA Retail Price VAT incl. |
|----------------|-----------------------|---|---|---|
| RS15000M02AL00 | Metallo Metall |  Alluminio Aluminum | Riflettore per FS15085250..NE, Reflector for FS15085250..NE | 40,00 € |
| RS30000M02AL00 | Metallo Metall |  Alluminio Aluminum | Riflettore per FS30090250..NE, Reflector for FS30090250..NE | 50,00 € |

SERPENTINE
GABI PERETTO
2011

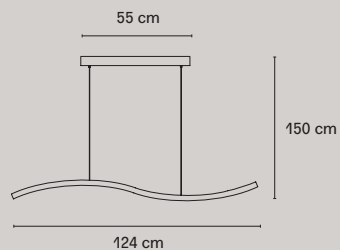

| Codice Code | Materiale Material | Colore Colour | Sorgente luminosa Light source | Dimmerabile Dimmable | Classe energetica Energy label | Prezzo Retail con IVA Retail Price VAT incl. |
|----------------|-------------------------------------|-------------------|--|-----------------------|--------------------------------|--|
| F417585350BILE | Polimero, Metallo Polymer, Metal | ○ Bianco White | LED 364x23W (3500K, CRI>80, 2090Lm) | Si, DALI Yes, DALI | F | 880,00 € |
| | | | LED integrato Integrated LED | CE ENEC Intertek | IP20 | |

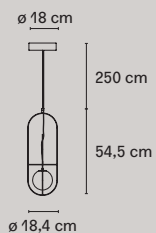

SETAREH
FRANCESCO LIBRIZZI
2017



| Codice Code | Materiale Material | Colore Colour | Sorgente luminosa Light source | Dimmerabile Dimmable | Classe energetica Energy label | Prezzo Retail con IVA Retail Price VAT incl. |
|----------------|--|--|---|---------------------------------------|--------------------------------|--|
| F438080550NBLE | Vetro, Metallo Galvanizzato Glass, Galvanized Metal | ● Nero lucido, Bianco Glossy black, White | LED 12W (2700K, CRI>80, 1550Lm) | Si, 1-10V / PUSH Yes, 1-10V / PUSH | E | 940,00 € |
| F438080550OBLE | Vetro, Metallo Galvanizzato Glass, Galvanized Metal | ● Oro lucido, Bianco Glossy gold, White | LED 12W (2700K, CRI>80, 1550Lm) | Si, 1-10V / PUSH Yes, 1-10V / PUSH | E | 940,00 € |
| | | | LED integrato Integrated LED | CE ENEC Intertek | IP20 | |
| | | | Possibilità di acquisto con tecnologia Dali o Casambi su richiesta Dali or Casambi technology on request | | | |

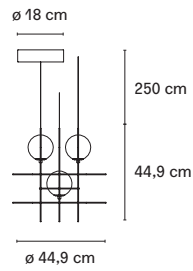



| Codice Code | Materiale Material | Colore Colour | Sorgente luminosa Light source | Dimmerabile Dimmable | Classe energetica Energy label | Prezzo Retail con IVA Retail Price VAT incl. |
|----------------|---|---|----------------------------------|------------------------------------|--------------------------------|--|
| F438380550NBLE | Vetro, Metallo Galvanizzato Glass, Galvanized Metal |  Nero lucido, Bianco Glossy black, White | LED 3x6W (2700K, CRI>80, 2500Lm) | Si, 1-10V / PUSH Yes, 1-10V / PUSH | E | 1.800,00 € |
| F438380550OBLE | Vetro, Metallo Galvanizzato Glass, Galvanized Metal |  Oro lucido, Bianco Glossy gold, White | LED 3x6W (2700K, CRI>80, 2500Lm) | Si, 1-10V / PUSH Yes, 1-10V / PUSH | E | 1.800,00 € |





LED integrato
Integrated LED

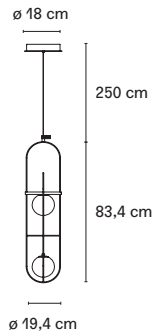

Su richiesta tecnologia
Dali o Casambi
Dali or Casambi
technology on request



| Codice Code | Materiale Material | Colore Colour | Sorgente luminosa Light source | Dimmerabile Dimmable | Classe energetica Energy label | Prezzo Retail con IVA Retail Price VAT incl. |
|----------------|---|---|----------------------------------|------------------------------------|--------------------------------|--|
| F440485550NBLE | Vetro, Metallo Galvanizzato Glass, Galvanized Metal |  Nero lucido, Bianco Glossy black, White | LED 2x6W (2700K, CRI>80, 1660Lm) | Si, 1-10V / PUSH Yes, 1-10V / PUSH | E | 1.300,00 € |
| F440485550OBLE | Vetro, Metallo Galvanizzato Glass, Galvanized Metal |  Oro lucido, Bianco Glossy gold, White | LED 2x6W (2700K, CRI>80, 1660Lm) | Si, 1-10V / PUSH Yes, 1-10V / PUSH | E | 1.300,00 € |







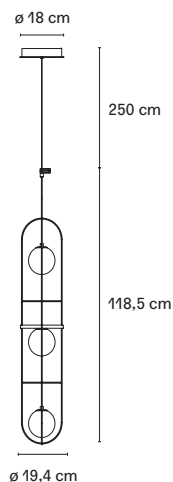

LED integrato
Integrated LED









Su richiesta tecnologia
Dali o Casambi
Dali or Casambi
technology on request

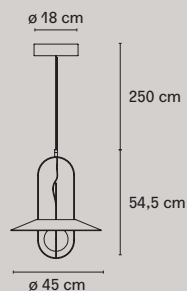

| Codice Code | Materiale Material | Colore Colour | Sorgente luminosa Light source | Dimmerabile Dimmable | Classe energetica Energy label | Prezzo Retail con IVA Retail Price VAT incl. |
|--|---|---|--|--|--------------------------------|--|
| F440590550NBLE | Vetro, Metallo Galvanizzato Glass, Galvanized Metal |  Nero lucido, Bianco Glossy black, White | LED 3x6W (2700K, CRI>80, 2500Lm) | Si, 1-10V / PUSH Yes, 1-10V / PUSH | E | 1.750,00 € |
| F440590550OBLE | Vetro, Metallo Galvanizzato Glass, Galvanized Metal |  Oro lucido, Bianco Glossy gold, White | LED 3x6W (2700K, CRI>80, 2500Lm) | Si, 1-10V / PUSH Yes, 1-10V / PUSH | E | 1.750,00 € |
|  VETRO SOFFIATO BLOWN GLASS | | | LED integrato Integrated LED |    IP20 | | |
| | | | Su richiesta tecnologia Dali o Casambi Dali or Casambi technology on request | | | |

SETAREH FRANCESCO LIBRIZZI 2017



| Codice Code | Materiale Material | Colore Colour | Sorgente luminosa Light source | Dimmerabile Dimmable | Classe energetica Energy label | Prezzo Retail con IVA Retail Price VAT incl. |
|--|---|---|--|--|--------------------------------|--|
| F438G80550NBLE | Vetro, Metallo Galvanizzato Glass, Galvanized Metal |  Nero lucido, Bianco Glossy black, White | LED 12W (2700K, CRI>80, 1550Lm) | Si, 1-10V / PUSH Yes, 1-10V / PUSH | E | 1.100,00 € |
| F438G80550OBLE | Vetro, Metallo Galvanizzato Glass, Galvanized Metal |  Oro lucido, Bianco Glossy gold, White | LED 12W (2700K, CRI>80, 1550Lm) | Si, 1-10V / PUSH Yes, 1-10V / PUSH | E | 1.100,00 € |
|  VETRO SOFFIATO BLOWN GLASS | | | LED integrato Integrated LED |    IP20 | | |
| Con diffusore in vetro With glass diffuser | | | Su richiesta tecnologia Dali o Casambi Dali or Casambi technology on request | | | |

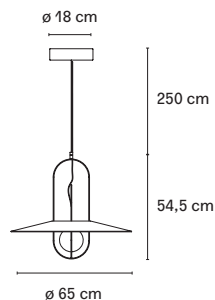

| Codice Code | Materiale Material | Colore Colour | Sorgente luminosa Light source | Dimmerabile Dimmable | Classe energetica Energy label | Prezzo Retail con IVA Retail Price VAT incl. |
|----------------|--|--|------------------------------------|---------------------------------------|--------------------------------|--|
| F438G85550NBLE | Vetro, Metallo Galvanizzato Glass, Galvanized Metal | ● Nero lucido, Bianco Glossy black, White | LED 12W (2700K, CRI>80, 1550Lm) | Si, 1-10V / PUSH Yes, 1-10V / PUSH | E | 1.200,00 € |
| F438G85550OBLE | Vetro, Metallo Galvanizzato Glass, Galvanized Metal | ● Oro lucido, Bianco Glossy gold, White | LED 12W (2700K, CRI>80, 1550Lm) | Si, 1-10V / PUSH Yes, 1-10V / PUSH | E | 1.200,00 € |



Con diffusore in vetro
With glass diffuser

LED integrato
Integrated LED



Su richiesta tecnologia
Dali o Casambi
Dali or Casambi
technology on request

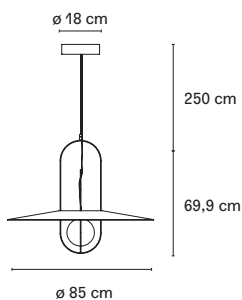

| Codice Code | Materiale Material | Colore Colour | Sorgente luminosa Light source | Dimmerabile Dimmable | Classe energetica Energy label | Prezzo Retail con IVA Retail Price VAT incl. |
|----------------|--|--|------------------------------------|---------------------------------------|--------------------------------|--|
| F438G90550NBLE | Vetro, Metallo Galvanizzato Glass, Galvanized Metal | ● Nero lucido, Bianco Glossy black, White | LED 17W (2700K, CRI>80, 2100Lm) | Si, 1-10V / PUSH Yes, 1-10V / PUSH | E | 1.450,00 € |
| F438G90550OBLE | Vetro, Metallo Galvanizzato Glass, Galvanized Metal | ● Oro lucido, Bianco Glossy gold, White | LED 17W (2700K, CRI>80, 2100Lm) | Si, 1-10V / PUSH Yes, 1-10V / PUSH | E | 1.450,00 € |



Con diffusore in vetro
With glass diffuser

LED integrato
Integrated LED



Su richiesta tecnologia
Dali o Casambi
Dali or Casambi
technology on request

SETAREH
FRANCESCO LIBRIZZI
2017

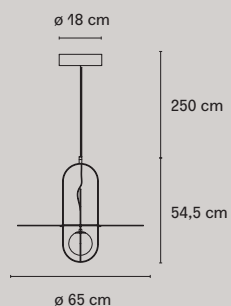

| Codice Code | Materiale Material | Colore Colour | Sorgente luminosa Light source | Dimmerabile Dimmable | Classe energetica Energy label | Prezzo Retail con IVA Retail Price VAT incl. |
|----------------|--|--|------------------------------------|---------------------------------------|--------------------------------|--|
| F438M85550NBLE | Vetro, Metallo Galvanizzato Glass, Galvanized Metal | ● Nero lucido, Bianco Glossy black, White | LED 12W (2700K, CRI>80, 1550Lm) | Si, 1-10V / PUSH Yes, 1-10V / PUSH | E | 1.450,00 € |
| F438M85550OBLE | Vetro, Metallo Galvanizzato Glass, Galvanized Metal | ● Oro lucido, Bianco Glossy gold, White | LED 12W (2700K, CRI>80, 1550Lm) | Si, 1-10V / PUSH Yes, 1-10V / PUSH | E | 1.450,00 € |



Con diffusore in metallo
With metal diffuser

LED integrato
Integrated LED



Su richiesta tecnologia
Dali o Casambi
Dali or Casambi
technology on request

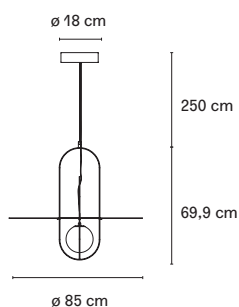

| Codice Code | Materiale Material | Colore Colour | Sorgente luminosa Light source | Dimmerabile Dimmable | Classe energetica Energy label | Prezzo Retail con IVA Retail Price VAT incl. |
|----------------|--|--|------------------------------------|---------------------------------------|--------------------------------|--|
| F438M90550NBLE | Vetro, Metallo Galvanizzato Glass, Galvanized Metal | ● Nero lucido, Bianco Glossy black, White | LED 17W (2700K, CRI>80, 2100Lm) | Si, 1-10V / PUSH Yes, 1-10V / PUSH | E | 1.600,00 € |
| F438M90550OBLE | Vetro, Metallo Galvanizzato Glass, Galvanized Metal | ● Oro lucido, Bianco Glossy gold, White | LED 17W (2700K, CRI>80, 2100Lm) | Si, 1-10V / PUSH Yes, 1-10V / PUSH | E | 1.600,00 € |



Con diffusore in metallo
With metal diffuser

LED integrato
Integrated LED





Su richiesta tecnologia
Dali o Casambi
Dali or Casambi
technology on request

THEA

GABRIELE E OSCAR BURATTI

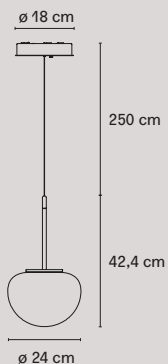
2022





| Codice Code | Materiale Material | Colore Colour | Sorgente luminosa Light source | Dimmerabile Dimmable | Classe energetica Energy label | Prezzo Retail con IVA Retail Price VAT incl. |
|----------------|---|--|-------------------------------------|-------------------------|--------------------------------|--|
| F444985550NFLE | Vetro, Metallo Galvanizzato Glass, Galvanized Metal |  Nero lucido, Fumè Glossy black, Grey fumè | LED 3,85W (3000K, CRI>90, 640Lm) | Si, TRIAC Yes, TRIAC | F | 1.090,00 € |
| F444985575RTLE | Vetro, Metallo Galvanizzato Glass, Galvanized Metal |  Rame lucido, Trasparente Glossy copper, Transparent | LED 3,85W (3000K, CRI>90, 640Lm) | Si, TRIAC Yes, TRIAC | F | 1.090,00 € |

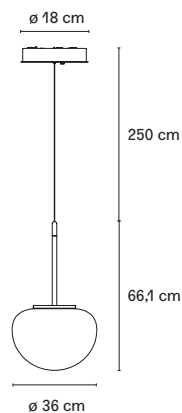

LED integrato
Integrated LED

CE IP40



| Codice Code | Materiale Material | Colore Colour | Sorgente luminosa Light source | Dimmerabile Dimmable | Classe energetica Energy label | Prezzo Retail con IVA Retail Price VAT incl. |
|----------------|---|--|--------------------------------------|-----------------------------------|--------------------------------|--|
| F444990550NFLE | Vetro, Metallo Galvanizzato Glass, Galvanized Metal |  Nero lucido, Fumè Glossy black, Grey fumè | LED 11,6W (3000K, CRI>90, 1596Lm) | Si, 1-10V/PUSH Yes, 1-10V/PUSH | F | 1.500,00 € |
| F444990575RTLE | Vetro, Metallo Galvanizzato Glass, Galvanized Metal |  Rame lucido, Trasparente Glossy copper, Transparent | LED 11,6W (3000K, CRI>90, 1596Lm) | Si, 1-10V/PUSH Yes, 1-10V/PUSH | F | 1.500,00 € |





LED integrato
Integrated LED

CE IP40

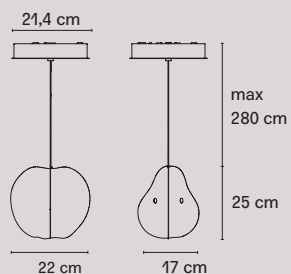

TUTTI
MELA/PERA - APPLE/PEAR
MATILDE CASSANI
2022



| Codice Code | Materiale Material | Colore Colour | Sorgente luminosa Light source | Dimmerabile Dimmable | Classe energetica Energy label | Prezzo Retail con IVA Retail Price VAT incl. |
|----------------|-----------------------|---|------------------------------------|--|-----------------------------------|---|
| F446880240CRLE | Metallo Metal |  Cromo Chrome | 12W LED (3000K, CRI>90, 1470Lm) | Si, TRIAC Yes, TRIAC | F | 570,00 € |
| F446880240OOLE | Metallo Metal |  Oro Gold | 12W LED (3000K, CRI>90, 1470Lm) | Si, TRIAC Yes, TRIAC | F | 600,00 € |
| | | | LED integrato Integrated LED |  IP20 | | |

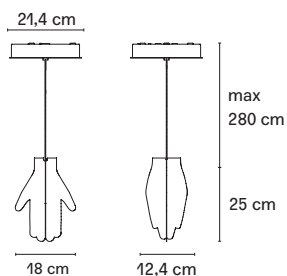

MANO APERTA/MANO CHIUSA -
HAND OPEN/HAND CLOSE



| Codice Code | Materiale Material | Colore Colour | Sorgente luminosa Light source | Dimmerabile Dimmable | Classe energetica Energy label | Prezzo Retail con IVA Retail Price VAT incl. |
|----------------|-----------------------|---|------------------------------------|--|-----------------------------------|---|
| F446980240CRLE | Metallo Metal |  Cromo Chrome | 12W LED (3000K, CRI>90, 1470Lm) | Si, TRIAC Yes, TRIAC | F | 560,00 € |
| F446980240OOLE | Metallo Metal |  Oro Gold | 12W LED (3000K, CRI>90, 1470Lm) | Si, TRIAC Yes, TRIAC | F | 590,00 € |
| | | | LED integrato Integrated LED |  IP20 | | |

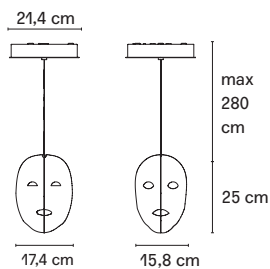

UOMO/DONNA -
MAN/WOMAN



| Codice Code | Materiale Material | Colore Colour | Sorgente luminosa Light source | Dimmerabile Dimmable | Classe energetica Energy label | Prezzo Retail con IVA Retail Price VAT incl. |
|------------------------------|--------------------|--|---------------------------------|---|--------------------------------|--|
| F447080240CRLE | Metallo Metal |  Cromo Chrome | 12W LED (3000K, CRI>90, 1470Lm) | Si, TRIAC Yes, TRIAC | F | 610,00 € |
| F447080240OOLE | Metallo Metal |  Oro Gold | 12W LED (3000K, CRI>90, 1470Lm) | Si, TRIAC Yes, TRIAC | F | 640,00 € |
| LED integrato Integrated LED | | | |  | | |

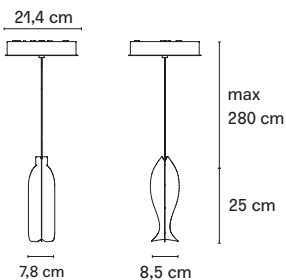

BOTTIGLIA/PESCE -
BOTTLE/FISH



| Codice Code | Materiale Material | Colore Colour | Sorgente luminosa Light source | Dimmerabile Dimmable | Classe energetica Energy label | Prezzo Retail con IVA Retail Price VAT incl. |
|------------------------------|--------------------|--|---------------------------------|---|--------------------------------|--|
| F447180240CRLE | Metallo Metal |  Cromo Chrome | 12W LED (3000K, CRI>90, 1470Lm) | Si, TRIAC Yes, TRIAC | F | 440,00 € |
| F447180240OOLE | Metallo Metal |  Oro Gold | 12W LED (3000K, CRI>90, 1470Lm) | Si, TRIAC Yes, TRIAC | F | 460,00 € |
| LED integrato Integrated LED | | | |  | | |

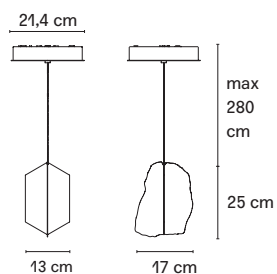

SASSO/DIAMANTE - STONE/DIAMOND



| Codice Code | Materiale Material | Colore Colour | Sorgente luminosa Light source | Dimmerabile Dimmable | Classe energetica Energy label | Prezzo Retail con IVA Retail Price VAT incl. |
|---------------------------------|-----------------------|---|------------------------------------|--|-----------------------------------|---|
| F447380240CRLE | Metallo Metal |  Cromo Chrome | 12W LED (3000K, CRI>90, 1470Lm) | Si, TRIAC Yes, TRIAC | F | 530,00 € |
| F447380240OOLE | Metallo Metal |  Oro Gold | 12W LED (3000K, CRI>90, 1470Lm) | Si, TRIAC Yes, TRIAC | F | 560,00 € |
| LED integrato Integrated LED | | | |  IP20 | | |

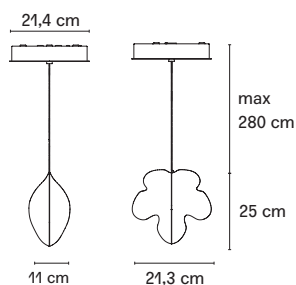

FOGLIE - LEAVES



| Codice Code | Materiale Material | Colore Colour | Sorgente luminosa Light source | Dimmerabile Dimmable | Classe energetica Energy label | Prezzo Retail con IVA Retail Price VAT incl. |
|---------------------------------|-----------------------|---|------------------------------------|--|-----------------------------------|---|
| F447280240CRLE | Metallo Metal |  Cromo Chrome | 12W LED (3000K, CRI>90, 1470Lm) | Si, TRIAC Yes, TRIAC | F | 500,00 € |
| F447280240OOLE | Metallo Metal |  Oro Gold | 12W LED (3000K, CRI>90, 1470Lm) | Si, TRIAC Yes, TRIAC | F | 530,00 € |
| LED integrato Integrated LED | | | |  IP20 | | |

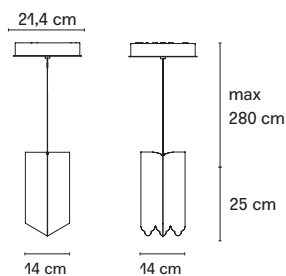

DRAPPO/SCUDETTO -
DRAPE/BADGE



| Codice Code | Materiale Material | Colore Colour | Sorgente luminosa Light source | Dimmerabile Dimmable | Classe energetica Energy label | Prezzo Retail con IVA Retail Price VAT incl. |
|------------------------------|--------------------|--|---------------------------------|---|--------------------------------|--|
| F447480240CRLE | Metallo Metal |  Cromo Chrome | 12W LED (3000K, CRI>90, 1470Lm) | Si, TRIAC Yes, TRIAC | F | 590,00 € |
| F447480240OOLE | Metallo Metal |  Oro Gold | 12W LED (3000K, CRI>90, 1470Lm) | Si, TRIAC Yes, TRIAC | F | 620,00 € |
| LED integrato Integrated LED | | | |  | | |

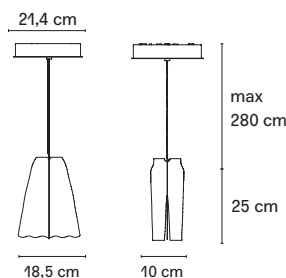

GONNA / PANTALONI -
SKIRT / TROUSERS



| Codice Code | Materiale Material | Colore Colour | Sorgente luminosa Light source | Dimmerabile Dimmable | Classe energetica Energy label | Prezzo Retail con IVA Retail Price VAT incl. |
|------------------------------|--------------------|--|---------------------------------|---|--------------------------------|--|
| F447580240CRLE | Metallo Metal |  Cromo Chrome | 12W LED (3000K, CRI>90, 1470Lm) | Si, TRIAC Yes, TRIAC | F | 520,00 € |
| F447580240OOLE | Metallo Metal |  Oro Gold | 12W LED (3000K, CRI>90, 1470Lm) | Si, TRIAC Yes, TRIAC | F | 550,00 € |
| LED integrato Integrated LED | | | |  | | |

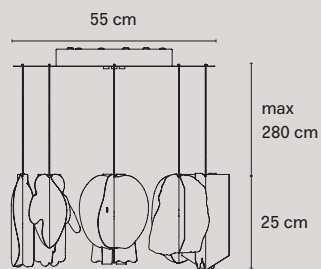

TUTTI
MATILDE CASSANI
2022

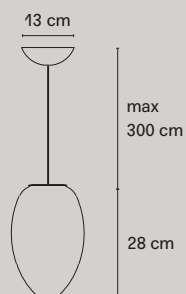

| Codice Code | Materiale Material | Colore Colour | Sorgente luminosa Light source | Dimmerabile Dimmable | Classe energetica Energy label | Prezzo Retail con IVA Retail Price VAT incl. |
|---------------------------------|-----------------------|---|--------------------------------------|--|-----------------------------------|---|
| F446890240CRLE | Metallo Metal |  Cromo Chrome | 3x12W LED (3000K, CRI>90, 4410Lm) | Si, TRIAC Yes, TRIAC | F | 3.000,00 € |
| F446890240OOLE | Metallo Metal |  Oro Gold | 3x12W LED (3000K, CRI>90, 4410Lm) | Si, TRIAC Yes, TRIAC | F | 3.300,00 € |
| LED integrato Integrated LED | | | |  IP20 | | |

UOVO
BEN SWILDENS
1972



| Codice Code | Materiale Material | Colore Colour | Sorgente luminosa Light source | Dimmerabile Dimmable | Classe energetica Energy label | Prezzo Retail con IVA Retail Price VAT incl. |
|----------------|-----------------------|---|-----------------------------------|--|---|---|
| F264680100BINE | Vetro Glass |  Bianco White | 1x max 30W E27 | Si Yes | Vedi tabella p. 181 See table p. 181 | 300,00 € |
| | | | |  IP20 | | |



OUTDOOR

NASKA XL p. 133

OORT SISTEMA p. 133

UOVO RIC. / REC. p. 136

UOVO p. 136

NASKA XL
HISTORICAL ARCHIVE
1933

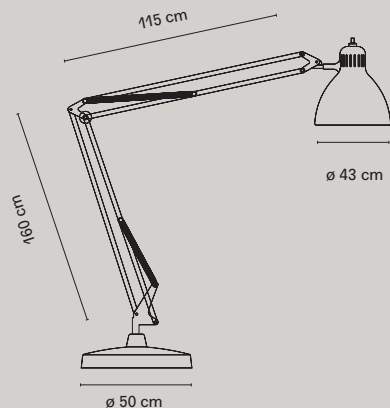

| Codice Code | Materiale Material | Colore Colour | Sorgente luminosa Light source | Dimmerabile Dimmable | Classe energetica Energy label | Prezzo Retail con IVA Retail Price VAT incl. |
|----------------|-------------------------------------|-------------------|--------------------------------|----------------------|---|--|
| F810528200BINE | Metallo Verniciato Painted Metal | ○ Bianco White | 1x max 42W E27 | No | Vedi tabella p. 181 See table p. 181 | 3.600,00 € |
| F810528200NENE | Metallo Verniciato Painted Metal | ● Nero Black | 1x max 42W E27 | No | Vedi tabella p. 181 See table p. 181 | 3.600,00 € |

CE IP54

OORT SISTEMA
JACOPO RODA
2023

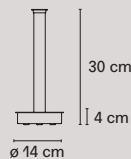

| Codice Code | Materiale Material | Colore Colour | Sorgente luminosa Light source | Dimmerabile Dimmable | Classe energetica Energy label | Prezzo Retail con IVA Retail Price VAT incl. |
|-------------|--------------------------------|-----------------------------------|----------------------------------|----------------------|--------------------------------|--|
| OORT05001 | Vetro, Metallo Glass, Metal | ● Nero micaceo Micaceous black | LED 6W (3000K, 570Lm) | Sì, Yes | G | 415,00 € |
| OORT05011 | Vetro, Metallo Glass, Metal | ● Nero micaceo Micaceous black | LED 6W (DTW da 1800K a 4000K) | Sì, Yes | G | 445,00 € |

LED integrato
Integrated LED

CE Classe III
IP65

Su richiesta a 2700K.
Alimentatore non incluso.
2700K on request. Power
supply not included.

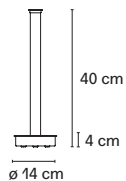

| Codice Code | Materiale Material | Colore Colour | Sorgente luminosa Light source | Dimmerabile Dimmable | Classe energetica Energy label | Prezzo Retail con IVA Retail Price VAT incl. |
|-------------|--------------------------------|-----------------------------------|----------------------------------|----------------------|--------------------------------|--|
| OORT05003 | Vetro, Metallo Glass, Metal | ● Nero micaceo Micaceous black | LED 8W (3000K, 760Lm) | Si, Yes | G | 440,00 € |
| OORT05013 | Vetro, Metallo Glass, Metal | ● Nero micaceo Micaceous black | LED 8W (DTW da 1800K a 4000K) | Si, Yes | G | 470,00 € |

LED integrato
Integrated LED



Su richiesta a 2700K.
Alimentatore non incluso.
2700K on request. Power
supply not included.

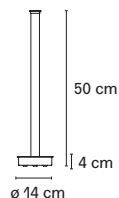

| Codice Code | Materiale Material | Colore Colour | Sorgente luminosa Light source | Dimmerabile Dimmable | Classe energetica Energy label | Prezzo Retail con IVA Retail Price VAT incl. |
|-------------|--------------------------------|-----------------------------------|-----------------------------------|----------------------|--------------------------------|--|
| OORT05005 | Vetro, Metallo Glass, Metal | ● Nero micaceo Micaceous black | LED 10W (3000K, 950Lm) | Si, Yes | G | 460,00 € |
| OORT05015 | Vetro, Metallo Glass, Metal | ● Nero micaceo Micaceous black | LED 10W (DTW da 1800K a 4000K) | Si, Yes | G | 490,00 € |

LED integrato
Integrated LED



Su richiesta a 2700K.
Alimentatore non incluso.
2700K on request. Power
supply not included.

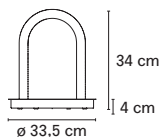

| Codice Code | Materiale Material | Colore Colour | Sorgente luminosa Light source | Dimmerabile Dimmable | Classe energetica Energy label | Prezzo Retail con IVA Retail Price VAT incl. |
|-------------|--------------------------------|-----------------------------------|-----------------------------------|----------------------|--------------------------------|--|
| OORT05031 | Vetro, Metallo Glass, Metal | ● Nero micaceo Micaceous black | LED 16W (3000K, 1520Lm) | Si, Yes | G | 625,00 € |
| OORT05041 | Vetro, Metallo Glass, Metal | ● Nero micaceo Micaceous black | LED 16W (DTW da 1800K a 4000K) | Si, Yes | G | 660,00 € |

LED integrato
Integrated LED



Su richiesta a 2700K.
Alimentatore non incluso.
2700K on request. Power
supply not included.

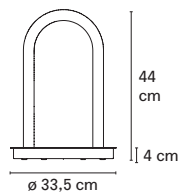

| Codice Code | Materiale Material | Colore Colour | Sorgente luminosa Light source | Dimmerabile Dimmable | Classe energetica Energy label | Prezzo Retail con IVA Retail Price VAT incl. |
|-------------|--------------------------------|-----------------------------------|-----------------------------------|----------------------|--------------------------------|--|
| OORT05033 | Vetro, Metallo Glass, Metal | ● Nero micaceo Micaceous black | LED 20W (3000K, 1900Lm) | Si, Yes | G | 650,00 € |
| OORT05043 | Vetro, Metallo Glass, Metal | ● Nero micaceo Micaceous black | LED 20W (DTW da 1800K a 4000K) | Si, Yes | G | 690,00 € |

LED integrato
Integrated LED



Su richiesta a 2700K.
Alimentatore non incluso.
2700K on request. Power
supply not included.

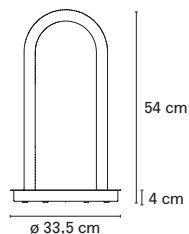

| Codice Code | Materiale Material | Colore Colour | Sorgente luminosa Light source | Dimmerabile Dimmable | Classe energetica Energy label | Prezzo Retail con IVA Retail Price VAT incl. |
|-------------|--------------------------------|-----------------------------------|-----------------------------------|----------------------|--------------------------------|--|
| OORT05035 | Vetro, Metallo Glass, Metal | ● Nero micaceo Micaceous black | LED 24W (3000K, 2280Lm) | Si, Yes | G | 690,00 € |
| OORT05045 | Vetro, Metallo Glass, Metal | ● Nero micaceo Micaceous black | LED 24W (DTW da 1800K a 4000K) | Si, Yes | G | 730,00 € |

LED integrato
Integrated LED



Su richiesta a 2700K.
Alimentatore non incluso.
2700K on request. Power
supply not included.

ALIMENTATORE / POWER SUPPLY



| Codice Code | Descrizione Description | Dimmerabile Dimmable | Prezzo Retail con IVA Retail Price VAT incl. |
|----------------|---------------------------|----------------------------------|--|
| RAL24020WL67ND | 24V 20W / 100-240V - IP67 | No | 53,00 € |
| RAL24017EU65DT | 24V 17W / 230-240V - IP65 | Si, TRIAC Yes, TRIAC | 53,00 € |
| RAL24060WL67VW | 24V 60W / 110-230V - IP67 | Si, 1-10V/PWM Yes, 1-10V/ PWM | 105,00 € |
| RAL24060WL67DA | 24V 60W / 110-230V - IP67 | Si, DALI Yes, DALI | 105,00 € |

ACCESSORI / ACCESSORY

| Codice Code | Descrizione Description | Prezzo Retail con IVA Retail Price VAT incl. |
|----------------|----------------------------|---|
| OORTPIC | Picchetto Spike | 32,00 € |

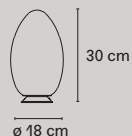
UOVO RICARICABILE / RECHARGEABLE BEN SWILDENS 1972



| Codice Code | Materiale Material | Colore Colour | Sorgente luminosa Light source | Dimmer incluso Dimmer included | Classe energetica Energy label | Prezzo Retail con IVA Retail Price VAT incl. |
|----------------|---|-------------------|--|--|-----------------------------------|---|
| F264600150BIBW | Vetro, Metallo Glass, Metal | ○ Bianco White | LED 2,2W (250Lm) | Si Yes | F | 395,00 € |
| |  | | LED integrato Integrated LED |  IP54 | | |
| | | | durata 8 ore alla massima potenza 8 hours duration at maximum power | | | |

UOVO BEN SWILDENS 1972

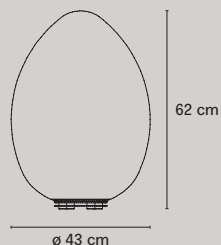

| Codice Code | Materiale Material | Colore Colour | Sorgente luminosa Light source | Dimmer incluso Dimmer included | Classe energetica Energy label | Prezzo Retail con IVA Retail Price VAT incl. |
|----------------|-------------------------------------|-------------------|-----------------------------------|-----------------------------------|---|---|
| F264613370BINE | Polimero, Metallo Polymer, Metal | ○ Bianco White | 1x max 30W E27 | No | Vedi tabella p. 181 See table p. 181 | 825,00 € |

  Classe II IPX4

ARREDO E VASI / FURNITURE AND VASES

FONTANA p. 139

TAVOLINO 1932 p. 140

TAVOLO CON RUOTE p. 140

TOUR p. 142

TESO p. 143

CARTOCCIO p. 144

CARTOCCIO Q p. 144

FONTANA
PIETRO CHIESA
1932

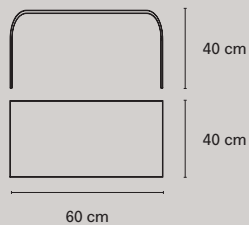

| Codice Code | Materiale Material | Colore Colour | Prezzo Retail con IVA Retail Price VAT incl. |
|----------------|-----------------------|--|---|
| F2600TB100TR00 | Vetro Glass |  Trasparente Transparent | 1.300,00 € |

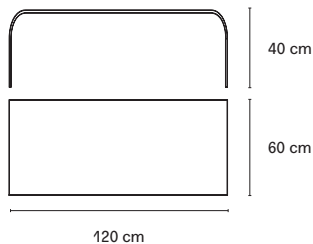

| Codice Code | Materiale Material | Colore Colour | Prezzo Retail con IVA Retail Price VAT incl. |
|----------------|-----------------------|--|---|
| F2610TB100TR10 | Vetro Glass |  Trasparente Transparent | 1.850,00 € |

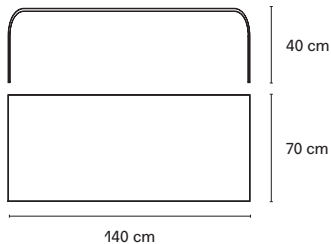

| Codice Code | Materiale Material | Colore Colour | Prezzo Retail con IVA Retail Price VAT incl. |
|----------------|-----------------------|--|---|
| F2620TB100TR20 | Vetro Glass |  Trasparente Transparent | 2.250,00 € |

TAVOLINO 1932
GIO PONTI
1932

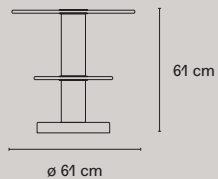

| Codice Code | Materiale Material | Colore Colour | Prezzo Retail con IVA Retail Price VAT incl. |
|----------------|--------------------------------|--|---|
| F2710TB150TR10 | Vetro, Metallo Glass, Metal | Trasparente, Nichel Transparent, Nickel | 2.400,00 € |

TAVOLO CON RUOTE
GAE AULENTI
1980

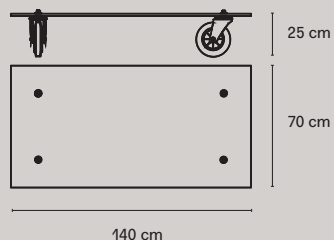

| Codice Code | Materiale Material | Colore Colour | Prezzo Retail con IVA Retail Price VAT incl. |
|----------------|--------------------------------|---|---|
| F1000TB150TR00 | Vetro, Metallo Glass, Metal | Trasparente, Nero Transparent, Black | 1.380,00 € |

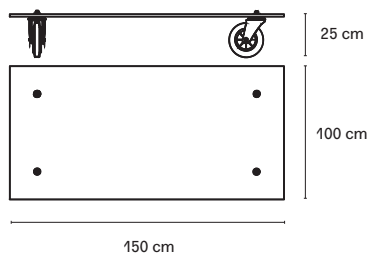

| Codice Code | Materiale Material | Colore Colour | Prezzo Retail con IVA Retail Price VAT incl. |
|----------------|--------------------------------|---|---|
| F1010TB150TR10 | Vetro, Metallo Glass, Metal | Trasparente, Nero Transparent, Black | 1.590,00 € |

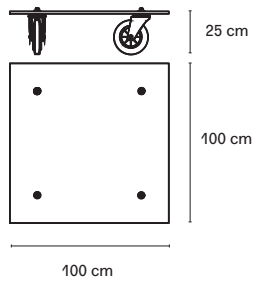

| Codice Code | Materiale Material | Colore Colour | Prezzo Retail con IVA Retail Price VAT incl. |
|----------------|--------------------------------|---|---|
| F1110TB150TR00 | Vetro, Metallo Glass, Metal |  Trasparente, Nero Transparent, Black | 1.380,00 € |

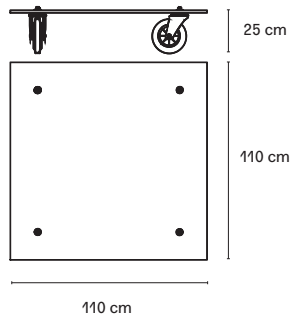

| Codice Code | Materiale Material | Colore Colour | Prezzo Retail con IVA Retail Price VAT incl. |
|----------------|--------------------------------|---|---|
| F1120TB150TR20 | Vetro, Metallo Glass, Metal |  Trasparente, Nero Transparent, Black | 1.560,00 € |

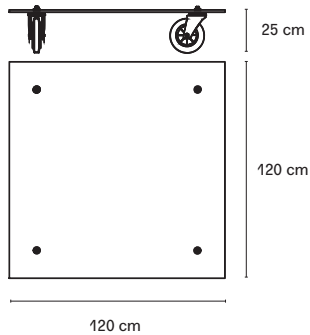

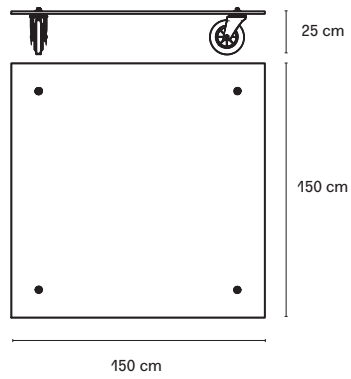

| Codice Code | Materiale Material | Colore Colour | Prezzo Retail con IVA Retail Price VAT incl. |
|----------------|--------------------------------|---|---|
| F1130TB150TR30 | Vetro, Metallo Glass, Metal |  Trasparente, Nero Transparent, Black | 1.590,00 € |

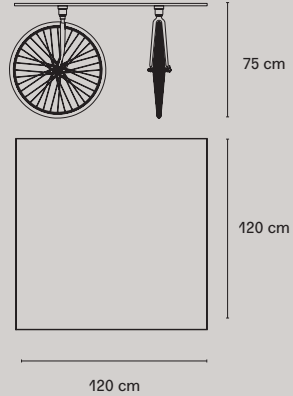

| Codice Code | Materiale Material | Colore Colour | Prezzo Retail con IVA Retail Price VAT incl. |
|----------------|--------------------------------|---|---|
| F1140TB150TR40 | Vetro, Metallo Glass, Metal |  Trasparente, Nero Transparent, Black | 2.050,00 € |

TOUR
GAE AULENTI
1993



| Codice Code | Materiale Material | Colore Colour | Prezzo Retail con IVA Retail Price VAT incl. |
|----------------|--------------------------------|---|---|
| F3010TA150TR10 | Vetro, Metallo Glass, Metal |  Trasparente, Cromo Transparent, Chrome | 5.950,00 € |

TESO
RENZO PIANO
 1985

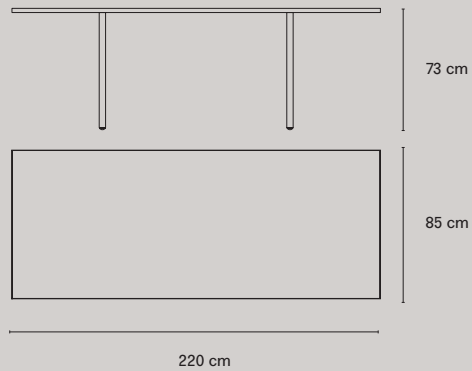

| Codice Code | Materiale Material | Colore Colour | Prezzo Retail con IVA Retail Price VAT incl. |
|----------------|--------------------------------|--|---|
| F2720TA150TR20 | Vetro, Metallo Glass, Metal |  Trasparente Transparent | 5.550,00 € |

TESO
RENZO PIANO
 1991

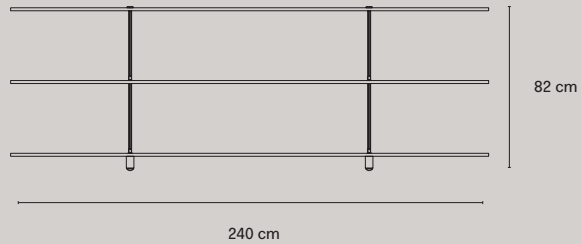

| Codice Code | Materiale Material | Colore Colour | Prezzo Retail con IVA Retail Price VAT incl. |
|----------------|--------------------------------|--|---|
| F2720CO150TR20 | Vetro, Metallo Glass, Metal |  Trasparente Transparent | 4.950,00 € |

TESO
RENZO PIANO
1989

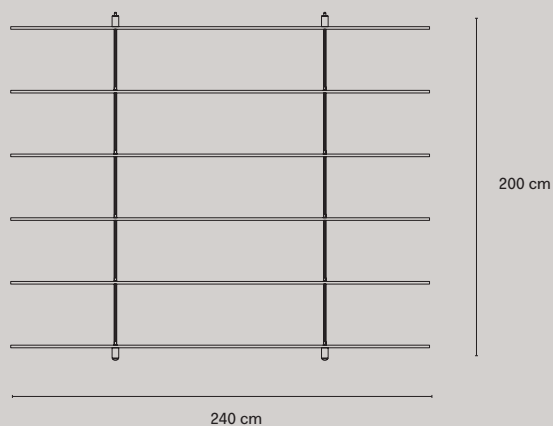

| Codice Code | Materiale Material | Colore Colour | Prezzo Retail con IVA Retail Price VAT incl. |
|----------------|--------------------------------|--|---|
| F2720LI150TR20 | Vetro, Metallo Glass, Metal |  Trasparente Transparent | 9.550,00 € |

CARTOCCIO
PIETRO CHIESA
1932



| Codice Code | Materiale Material | Colore Colour | Prezzo Retail con IVA Retail Price VAT incl. |
|----------------|-----------------------|---|---|
| F2910VA100OP10 | Vetro Glass |  Naturale Sabbciato Natural Sandblasted | 680,00 € |



| Codice Code | Materiale Material | Colore Colour | Prezzo Retail con IVA Retail Price VAT incl. |
|----------------|-----------------------|---|---|
| F2920VA100TR20 | Vetro Glass |  Naturale Sabbciato Natural Sandblasted | 760,00 € |

CARTOCCIO Q
PIETRO CHIESA
1932







| Codice Code | Materiale Material | Colore Colour | Prezzo Retail con IVA Retail Price VAT incl. |
|----------------|-----------------------|--|---|
| F3010VA100TR10 | Vetro Glass |  Trasparente Transparent | 550,00 € |







INFORMAZIONI TECNICHE / TECHNICAL NOTES





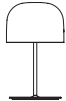

| | |
|--|--------|
| RICAMBI / SPARE PARTS | p. 147 |
| MISURE E PESI DELL'IMBALLO / PACKAGING MEASUREMENTS AND WEIGHT | p. 165 |
| TABELLA SORGENTI LUMINOSE / TABLE FOR LIGHTING SOURCE | p. 181 |
| LEGENDA / LEGEND | p. 187 |
| CONDIZIONI DI VENDITA / SALES CONDITION | p. 189 |

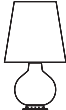

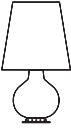

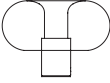

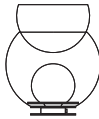
RICAMBI / SPARE PARTS



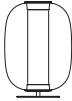

LAMPADE DA TAVOLO TABLE LAMPS









| Famiglia Family | | Codice prodotto finito Product code | Codice ricambio Spare part code | Descrizione Description | Prezzo Retail con IVA Retail Price VAT incl. |
|--------------------|---|--|------------------------------------|---|---|
| 3247TA |  | F324700150KBNE | R185300V01BI00 | Diffusore Superiore Top Diffuser | 230,00 € |
| | | | R324703M00NS00 | Montatura Mounting | 420,00 € |
| |  | F324710150KBNE | R185301V01BI00 | Diffusore Superiore Top Diffuser | 525,00 € |
| | | | R324702M00NS00 | Montatura Mounting | 580,00 € |
| BILIA MINI |  | F247400150BINE | R440400V00BI00 | Diffusore in vetro con ghiera Diffuser with metal ring | 130,00 € |
| | | F247400150BLNE | R440400V00BI00 | Diffusore in vetro con ghiera Diffuser with metal ring | 130,00 € |
| | | F247400150GINE | R440400V00BI00 | Diffusore in vetro con ghiera Diffuser with metal ring | 130,00 € |
| | | F247400150KBNE | R440400V00BI00 | Diffusore in vetro con ghiera Diffuser with metal ring | 130,00 € |
| | | F247400150NENE | R440400V00BI00 | Diffusore in vetro con ghiera Diffuser with metal ring | 130,00 € |
| | | F247400150RONE | R440400V00BI00 | Diffusore in vetro con ghiera Diffuser with metal ring | 130,00 € |
| | | F247400150TBNE | R440400V00BI00 | Diffusore in vetro con ghiera Diffuser with metal ring | 130,00 € |
| | | F247400150VENE | R440400V00BI00 | Diffusore in vetro con ghiera Diffuser with metal ring | 130,00 € |
| | | F247400550NENE | R440400V00BI00 | Diffusore in vetro con ghiera Diffuser with metal ring | 130,00 € |
| | | F247400550RSNE | R440400V00BI00 | Diffusore in vetro con ghiera Diffuser with metal ring | 130,00 € |
| BILIA MEDIA |  | F247405150KBNE | R247400V00BI00 | Diffusore bianco White diffuser | 170,00 € |
| | | F247405150TBNE | R247400V00BI00 | Diffusore bianco White diffuser | 170,00 € |
| | | F247405550NENE | R247400V00BI00 | Diffusore bianco White diffuser | 170,00 € |
| | | F247405550RSNE | R247400V00BI00 | Diffusore bianco White diffuser | 170,00 € |
| BIS - TRIS |  | F228005150TNNE | R228000V01NE00 | Diffusore superiore Top diffuser | 665,00 € |
| | | | R228000V02OP00 | Diffusore inferiore Bottom diffuser | 160,00 € |
| | | F228005150CBNE | R228000V01BI00 | Diffusore superiore Top diffuser | 570,00 € |
| | | | R228000V02OP00 | Diffusore inferiore Bottom diffuser | 160,00 € |

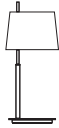

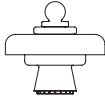
| Famiglia Family | | Codice prodotto finito Product code | Codice ricambio Spare part code | Descrizione Description | Prezzo Retail con IVA Retail Price VAT incl. | |
|---|---|---|------------------------------------|---|---|----------|
| DARUMA |  | F502800100BINE | R502800V01BI00 | Diffusore superiore Top diffuser | 175,00 € | |
| | | | R502800V02BI00 | Diffusore inferiore Bottom diffuser | 195,00 € | |
| |  | F502805100BINE | R502801V01BI00 | Diffusore superiore Top diffuser | 195,00 € | |
| | | | R502801V02BI00 | Diffusore superiore Top diffuser | 345,00 € | |
| |  | F502810100BINE | R502802V01BI00 | Diffusore superiore Top diffuser | 330,00 € | |
| | | | R502802V02BI00 | Diffusore inferiore Bottom diffuser | 705,00 € | |
| EQUATORE |  | F438900150OOWL | R438900V00BR00 | Diffusore Diffuser | 460,00 € | |
| | | F438900550NEWL | R438900V00NE00 | Diffusore Diffuser | 460,00 € | |
| | | F438900550RSWL | R438900V00RS00 | Diffusore Diffuser | 460,00 € | |
| | | F438900550CRWL | R438900V00TR00 | Diffusore Diffuser | 460,00 € | |
| |  | F438905150OOWL | R438901V00BR00 | Diffusore Diffuser | 570,00 € | |
| | | F438905550NEWL | R438901V00NE00 | Diffusore Diffuser | 570,00 € | |
| | | F438905550RSWL | R438901V00RS00 | Diffusore Diffuser | 570,00 € | |
| | | F438905550CRWL | R438901V00TR00 | Diffusore Diffuser | 570,00 € | |
| | FALENA |  | F301705150CRNE | R301600M08CR00 | Corpo Body | 390,00 € |
| | | | | R301700B00TR00 | Base Base | 350,00 € |
| | FONTANA |  | F185300100BINE | R185300V01BI00 | Diffusore superiore Top diffuser | 230,00 € |
| | | | | R185301V02BI00 | Globo Globe | 160,00 € |
| | | | R185301M00BI00 | Montatura completa Complete mounting | 555,00 € | |
| | | | R185301M01BI00 | Crociera reggivetrol Glassholder cross | 85,00 € | |
| | | | R185300T00NE00 | Tastiera Switch | 30,00 € | |
|  | | F185305100BINE | R185301V01BI00 | Diffusore superiore Top diffuser | 525,00 € | |
| | | | R185300V02BI00 | Globo Globe | 285,00 € | |
| | | | R185300M00BI00 | Montatura completa Complete mounting | 720,00 € | |
| | | | R185300M01BI00 | Crociera reggivetrol Glassholder cross | 115,00 € | |
| | | | R185300T00NE00 | Tastiera Switch | 30,00 € | |

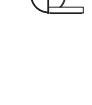
| Famiglia Family | | Codice prodotto finito Product code | Codice ricambio Spare part code | Descrizione Description | Prezzo Retail con IVA Retail Price VAT incl. |
|--------------------|---|--|------------------------------------|--|---|
| |  | F185310100BINE | R185302V01BI00 | Diffusore superiore Top diffuser | 1.075,00 € |
| | | | R185302V02BI00 | Globo Globe | 500,00 € |
| | | | R185302M00BI00 | Montatura completa Complete mounting | 1.185,00 € |
| | | | R248202M01BI00 | Crociera reggivetrol Glassholder cross | 120,00 € |
| | | | R185301T00NE00 | Tastiera Switch | 45,00 € |
| | | | R185300M02BI00 | Riflettore Top reflector | 65,00 € |
| FONTANELLA |  | F442305550CRNE | R442300V00TR00 | Diffusore Diffuser | 425,00 € |
| | | F442305550NENE | R442300V00TR00 | Diffusore Diffuser | 425,00 € |
| | | F442305550OTNE | R442300V00TR00 | Diffusore Diffuser | 425,00 € |
| |  | F442310550CRNE | R442301V00TR00 | Diffusore Diffuser | 645,00 € |
| | | F442310550NENE | R442301V00TR00 | Diffusore Diffuser | 645,00 € |
| | | F442310550OTNE | R442301V00TR00 | Diffusore Diffuser | 645,00 € |
| GIOVA |  | F268405150CRNE | R264800V02TR00 | Diffusore trasparente Transparent diffuser | 390,00 € |
| | | | R264800V03BI00 | Diffusore bianco White diffuser | 155,00 € |
| | | | R264800V01RS00 | Diffusore rosa Pink diffuser | 280,00 € |
| | | F268405575OONE | R264800V02TR00 | Diffusore trasparente Transparent diffuser | 390,00 € |
| | | | R264801V03BI00 | Diffusore bianco White diffuser | 185,00 € |
| | | | R264800V01GC00 | Diffusore grigio chiaro Light grey diffuser | 440,00 € |
| |  | F268410150CRNE | R264801V02TR00 | Diffusore trasparente Transparent diffuser | 880,00 € |
| | | | R264801V03BI00 | Diffusore bianco White diffuser | 185,00 € |
| | | | R264801V01RS00 | Diffusore rosa Pink diffuser | 455,00 € |
| | | F268410575OONE | R264801V02TR00 | Diffusore trasparente Transparent diffuser | 880,00 € |
| | | | R264801V03BI00 | Diffusore bianco White diffuser | 185,00 € |
| | | | R264801V01GC00 | Diffusore grigio chiaro Light grey diffuser | 500,00 € |
| MANO |  | F420805400NENE | R420800M00NE00 | Montatura Mounting | 530,00 € |
| | | | R420800V00NE00 | Diffusore Diffuser | 210,00 € |





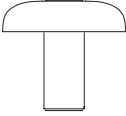

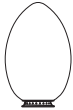
| Famiglia Family | | Codice prodotto finito Product code | Codice ricambio Spare part code | Descrizione Description | Prezzo Retail con IVA Retail Price VAT incl. |
|---|---|--|------------------------------------|----------------------------|---|
| MERIDIANO |  | F441705550NFWL | R441700V00NE00 | Diffusore Diffuser | 735,00 € |
| | | F441705550NRWL | R441700V00RS00 | Diffusore Diffuser | 735,00 € |
| | | F441705550NTWL | R441700V00TR00 | Diffusore Diffuser | 735,00 € |
| METAFORA |  | F265405150BTNE | R265400V00OP00 | Diffusore Diffuser | 520,00 € |
| NASKA |  | F810700200BINE | R800400M08BI00 | Corpo Body | 280,00 € |
| | | | R810700B00BI00 | Base Base | 95,00 € |
| | | F810700200NENE | R800400M08NE00 | Corpo Body | 370,00 € |
| | | | R810700B00NE00 | Base Base | 95,00 € |
| | | F810700240CRNE | R800400M08CR00 | Corpo Body | 415,00 € |
| | | | R810700B00CR00 | Base Base | 145,00 € |
| |  | F810100200BINE | R800400M08BI00 | Corpo Body | 280,00 € |
| | | | R810100B01BI00 | Morsetto Clamp | 40,00 € |
| | | F810100200NENE | R800400M08NE00 | Corpo Body | 370,00 € |
| | | | R810100B01NE00 | Morsetto Clamp | 40,00 € |
| | | F810100240CRNE | R800400M08CR00 | Corpo Body | 415,00 € |
| | | | R810100B01CR00 | Morsetto Clamp | 40,00 € |
|  | F810010200BINE | R800000M08BI00 | Corpo Body | 305,00 € | |
| | | R810000B00BI00 | Base Base | 175,00 € | |
| | F810010200NENE | R800000M08BI00 | Corpo Body | 305,00 € | |
| | | R810000B00NE00 | Base Base | 175,00 € | |
| | F810010240CRNE | R800000M08BI00 | Corpo Body | 305,00 € | |
| | | R810000B00CR00 | Base Base | 195,00 € | |
|  | F810010200BIWL | R802000M08BI00 | Corpo Body | 605,00 € | |
| | | R810000B00BI00 | Base Base | 175,00 € | |





| Famiglia Family | Codice prodotto finito Product code | Codice ricambio Spare part code | Descrizione Description | Prezzo Retail con IVA Retail Price VAT incl. | |
|---|---|------------------------------------|----------------------------|---|----------|
|  | F810010200NEWL | R802000M08NE00 | Corpo Body | 625,00 € | |
| | | R810000B00NE00 | Base Base | 175,00 € | |
| | F810010240CRWL | R802000M08CR00 | Corpo Body | 635,00 € | |
| | | R810000B00CR00 | Base Base | 195,00 € | |
| | F810010240OOWL | R802000M08OO00 | Corpo Body | 770,00 € | |
| | | R810000B00OO00 | Base Base | 230,00 € | |
| | F81010200BINE | R800000M08BI00 | Corpo Body | 305,00 € | |
| | | R810100B01BI00 | Morsetto Clamp | 40,00 € | |
| | F81010200NENE | R800000M08NE00 | Corpo Body | 410,00 € | |
| | | R810100B01NE00 | Morsetto Clamp | 40,00 € | |
| | F81010240CRNE | R800000M08CR00 | Corpo Body | 440,00 € | |
| | | R810100B01CR00 | Morsetto Clamp | 40,00 € | |
| PALLINA |  | F443000150NENE | R440400V00BI00 | Diffusore Diffuser | 130,00 € |
| | | F443000150NSNE | R440400V00BI00 | Diffusore Diffuser | 130,00 € |
| | | F443000150OTNE | R440400V00BI00 | Diffusore Diffuser | 130,00 € |
| | | F443000150ORNE | R440400V00BI00 | Diffusore Diffuser | 130,00 € |
| PAROLA |  | F265805100AMNE | R265800B00TR00 | Montatura Mounting | 355,00 € |
| | | | R265800V00AM00 | Diffusore Diffuser | 340,00 € |
| | | F265805100BINE | R265800B00TR00 | Montatura Mounting | 355,00 € |
| | | | R265800V00BI00 | Diffusore Diffuser | 340,00 € |
| PASSION |  | F361000150CRNE | R361000M00CR00 | Montatura Mounting | 545,00 € |
| | | | R361000V00BI00 | Diffusore bianco White diffuser | 170,00 € |
| | | | R361000M01CR00 | Crociera reggivetro Glassholder cross | 65,00 € |
| | | F361000150NCNE | R361000M00NS00 | Montatura Mounting | 545,00 € |
| | | | R361000V00BI00 | Diffusore bianco White diffuser | 170,00 € |
| | | | R361000M01NS00 | Crociera reggivetro Glassholder cross | 65,00 € |





| Famiglia Family | | Codice prodotto finito Product code | Codice ricambio Spare part code | Descrizione Description | Prezzo Retail con IVA Retail Price VAT incl. |
|--------------------|---|--|---|---|---|
| |  | F361005150CRNE | R361001M00CR00 | Montatura Mounting | 880,00 € |
| | | | R361001V00BI00 | Diffusore Diffuser | 315,00 € |
| | | | R361001M01CR00 | Crociera reggivetro Glassholder cross | 90,00 € |
| | | F361005150NCNE | R361001M00NS00 | Montatura Mounting | 880,00 € |
| | | | R361001V00BI00 | Diffusore Diffuser | 315,00 € |
| | | | R361001M01NS00 | Crociera reggivetro Glassholder cross | 90,00 € |
| PIRELLINA |  | F278205150KBNE | R278200V00BI00 | Diffusori Diffusers | 285,00 € |
| RE |  | F443810100BIWL | R443800V00BI00 | Diffusore superiore Top diffuser | 465,00 € |
| | | | R443800V02BI00 | Diffusore inferiore Bottom diffuser | 445,00 € |
| | | | R443800V03BI00 | Diffusore centrale Central diffuser | 850,00 € |
| REGINA |  | F443710100BIWL | R443700V00BI01 | Diffusore superiore Top diffuser | 455,00 € |
| | | | R443700V00BI00 | Diffusore centrale Central diffuser | 925,00 € |
| SETAREH |  | F440105500NBWL | R440400V00BI00 | Diffusore in vetro con ghiera / Diffuser with metal ring | 130,00 € |
| | | | R440400V00BI00 | Diffusore in vetro con ghiera / Diffuser with metal ring | 130,00 € |
| |  | F438405500NBWL | R438G00V00BI00 | Diffusore Diffuser | 160,00 € |
| | | | R440400V00BI00 | Diffusore in vetro con ghiera / Diffuser with metal ring | 130,00 € |
| |  | F438405500OBWL | R438G00V00BI00 | Diffusore Diffuser | 160,00 € |
| | | | R440400V00BI00 | Diffusore in vetro con ghiera / Diffuser with metal ring | 130,00 € |
| THEA |  | F444905550NFWL | R444905V00FU00 | Diffusore Diffuser | 300,00 € |
| | | | R444905575RTWL | Diffusore Diffuser | 300,00 € |
| |  | F444910550NFWL | R444910V00FU00 | Diffusore Diffuser | 490,00 € |
| | | | F444910575RTWL | Diffusore Diffuser | 490,00 € |
| THOR |  | F329500100BINE | R329501V00BI00 | Diffusore Diffuser | 320,00 € |
| | | |  | F329505100BINE | R329500V00BI00 |

| Famiglia Family | | Codice prodotto finito Product code | Codice ricambio Spare part code | Descrizione Description | Prezzo Retail con IVA Retail Price VAT incl. |
|--------------------|---|--|------------------------------------|----------------------------|---|
| TROPICO |  | F442105585BIWL | R443101V00BI00 | Diffusore Diffuser | 355,00 € |
| | | F442105585GCWL | R443101V00BI00 | Diffusore Diffuser | 355,00 € |
| | | F442105585NEWL | R443101V00BI00 | Diffusore Diffuser | 355,00 € |
| |  | F442110585BIWL | R443102V00BI00 | Diffusore Diffuser | 475,00 € |
| | | F442110585GCWL | R443102V00BI00 | Diffusore Diffuser | 475,00 € |
| | | F442110585NEWL | R443102V00BI00 | Diffusore Diffuser | 475,00 € |
| UOVO |  | F264600100BINE | R264601V00BI00 | Diffusore Diffuser | 220,00 € |
| | | | R264601M00BI00 | Montatura Mounting | 205,00 € |
| |  | F264605100BINE | R264602V00BI00 | Diffusore Diffuser | 295,00 € |
| | | | R264602M00BI00 | Montatura Mounting | 230,00 € |
| |  | F264610100BINE | R264600V00BI00 | Diffusore Diffuser | 545,00 € |
| | | | R264600M00BI00 | Montatura Mounting | 285,00 € |







LAMPADE DA TERRA FLOOR LAMPS



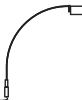



| Famiglia Family | | Codice prodotto finito Product code | Codice ricambio Spare part code | Descrizione Description | Prezzo Retail con IVA Retail Price VAT incl. | |
|--------------------|---|--|------------------------------------|--|---|----------|
| 0024 |  | F002430150TRNE | R002401V00TR00 | Diffusori Diffusers | 725,00 € | |
| | | | R002401M00CR00 | Montatura Mounting | 1.770,00 € | |
| 3247 |  | F324725150KBNE | R185301V01BI00 | Diffusore Diffuser | 525,00 € | |
| | | | R324701M00NS00 | Montatura Mounting | 850,00 € | |
| |  | F324730150KBNE | R185302V01BI00 | Diffusore Diffuser | 1.075,00 € | |
| | | | R324700M00NS00 | Montatura Mounting | 1.350,00 € | |
| EQUATORE |  | F439220150OOWL | R438900V00BR00 | Diffusore Diffuser | 460,00 € | |
| | | | F439220550NEWL | R438900V00NE00 | Diffusore Diffuser | 460,00 € |
| | | | F439220550RSWL | R438900V00RS00 | Diffusore Diffuser | 460,00 € |
| | | | F439220550CRWL | R438900V00TR00 | Diffusore Diffuser | 460,00 € |
| |  | F439225550NEWL | R438901V00NE00 | Diffusore Diffuser | 570,00 € | |
| | | | F439225150OOWL | R438901V00BR00 | Diffusore Diffuser | 570,00 € |
| | | | F439225550RSWL | R438901V00RS00 | Diffusore Diffuser | 570,00 € |
| | | | 439225550CRWL | R438901V00TR00 | Diffusore Diffuser | 570,00 € |
| FALENA |  | F301825150CRNE | R301600M08CR00 | Corpo Body | 390,00 € | |
| | | | R301800B00TR00 | Base Base | 655,00 € | |
| FLÛTE |  | F330025150TCNE | R330000V04TC00 | Diffusore per attacco E27 Diffuser for E27 socket | 775,00 € | |









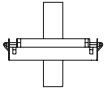

| Famiglia Family | | Codice prodotto finito Product code | Codice ricambio Spare part code | Descrizione Description | Prezzo Retail con IVA Retail Price VAT incl. |
|--------------------|---|--|------------------------------------|------------------------------|---|
| |  | F330030150TCNE | R330000M00TC00 | Montatura Mounting | 2.100,00 € |
| | | | R330000B00CR00 | Base Base | 445,00 € |
| | | | R330001V04TC00 | Stelo in vetro Glass stem | 1.220,00 € |
| GALERIE |  | F440025500QZWL | R440000V00QZ00 | Diffusore Diffuser | 200,00 € |
| | | | F447630500QZWL | R440000V00QZ00 | Diffusore Diffuser |
| LUMEN |  | F248225150BINE | R185302V01BI00 | Diffusore Diffuser | 1.075,00 € |
| | | | | R248200M00BI00 | Montatura Mounting |
| MERIDIANO |  | F441725550NFWL | R441700V00NE00 | Diffusore Diffuser | 735,00 € |
| | | F441725550NRWL | R441700V00RS00 | Diffusore Diffuser | 735,00 € |
| | | F441725550NTWL | R441700V00TR00 | Diffusore Diffuser | 735,00 € |
| PAROLA |  | F268945150AMNE | R265800V00AM00 | Diffusore Diffuser | 340,00 € |
| | | F268945150BINE | R265800V00BI00 | Diffusore Diffuser | 340,00 € |

| Famiglia Family | | Codice prodotto finito Product code | Codice ricambio Spare part code | Descrizione Description | Prezzo Retail con IVA Retail Price VAT incl. |
|----------------------|--|--|------------------------------------|---------------------------------------|---|
| PAROLONA |  | F275130150BINE | R275100V00BI00 | Diffusore Diffuser | 415,00 € |
| PIRELLONE |  | F275930150KBNE | R275900V00BI00 | Diffusore Singolo Single Diffuser | 915,00 € |
| | | | R275901V00BI00 | Diffusore Doppio Double Diffuser | 1.520,00 € |
| | | | R275800M00NS00 | Montatura Mounting | 1.805,00 € |
| PRIMA SIGNORA |  | F289130150CBNE | R289100V00BI00 | Diffusore Diffuser | 570,00 € |
| THEA |  | F444930550NFWL | R444910V00FU00 | Diffusore Diffuser | 490,00 € |
| | | F444930575RTWL | R444910V00TR00 | Diffusore Diffuser | 490,00 € |
| SCINTILLA |  | F272930250CRNE | RP15000V05TR00 | Schermo superiore Upper protection | 23,00 € |
| | | | RP15000V06TR00 | Schermo inferiore Lower protection | 23,00 € |
| | | | RS15000M02AL00 | Riflettore Reflector | 40,00 € |
| | | F272930250NSNE | RP15000V05TR00 | Schermo Superiore Upper Protection | 23,00 € |
| | | | RP15000V06TR00 | Schermo Inferiore Lower Protection | 23,00 € |
| | | | RS15000M02AL00 | Riflettore Reflector | 40,00 € |





LAMPADE A PARETE E A PLAFONE WALL AND CEILING LAMPS





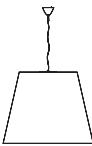
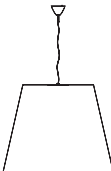
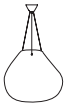
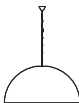
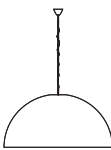

| Famiglia Family | | Codice prodotto finito Product code | Codice ricambio Spare part code | Descrizione Description | Prezzo Retail con IVA Retail Price VAT incl. |
|--------------------|---|--|------------------------------------|--|---|
| BRUCO |  | F353845100BINE | R353800V01BI00 | Diffusore superiore Top diffuser | 90,00 € |
| | | F353845100BINE | R353800V02BI00 | Diffusore inferiore Bottom diffuser | 145,00 € |
| FALENA |  | F301945150CRNE | R301600M08CR00 | Corpo Body | 390,00 € |
| | | | R301900B02CR00 | Montatura Mounting | 190,00 € |
| FRENESI |  | F446745550TCLE | R446745V00TR00 | Diffusore Diffuser | 1.450,00 € |
| NASKA |  | F810340200BINE | R800400M08BI00 | Corpo Body | 280,00 € |
| | | | R810300B02BI00 | Attacco a parete Wall support | 40,00 € |
| | | F810340200NENE | R800400M08NE00 | Corpo Body | 370,00 € |
| | | | R810300B02NE00 | Attacco a parete Wall support | 40,00 € |
| |  | F810340240CRNE | R800400M08CR00 | Corpo Body | 415,00 € |
| | | | R810300B02CR00 | Attacco a parete Wall support | 40,00 € |
| | | F810350200BINE | R800000M08BI00 | Corpo Body | 305,00 € |
| | | | R810300B02BI00 | Attacco a parete Wall support | 40,00 € |
| |  | F810350200NENE | R800000M08NE00 | Corpo Body | 410,00 € |
| | | | R810300B02NE00 | Attacco a parete Wall support | 40,00 € |
| | | F810350240CRNE | R800000M08CR00 | Corpo Body | 440,00 € |
| | | | R810300B02CR00 | Attacco a parete Wall support | 40,00 € |
| |  | F810350200BIWL | R802000M08BI00 | Corpo Body | 605,00 € |
| | | | R810300B02BI00 | Attacco a parete Wall support | 40,00 € |
| F8103450200NEWL | | R802000M08NE00 | Corpo Body | 625,00 € | |
| | | R810300B02NE00 | Attacco a parete Wall support | 40,00 € | |
| | F810350240CRWL | R802000M08CR00 | Corpo Body | 635,00 € | |
| | | R810300B02CR00 | Attacco a parete Wall support | 40,00 € | |



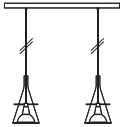
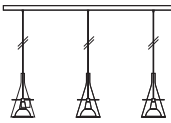

| Famiglia Family | | Codice prodotto finito Product code | Codice ricambio Spare part code | Descrizione Description | Prezzo Retail con IVA Retail Price VAT incl. |
|--------------------|---|--|------------------------------------|---------------------------------------|---|
| | | F810350240OOWL | R802000M08OO00 | Corpo Body | 770,00 € |
| | | | R810300B02NE00 | Attacco a parete Wall support | 40,00 € |
| NOBI |  | F302345150BINE | R308600V00OP00 | Diffusore Diffuser | 70,00 € |
| | | | R308600M02AL00 | Riflettore Reflector | 85,00 € |
| | | F302345150CRLE | R308600V00OP00 | Diffusore Diffuser | 70,00 € |
| | | | R308600M02AL00 | Riflettore Reflector | 85,00 € |
| | | F302345150NSLE | R308600V00OP00 | Diffusore Diffuser | 70,00 € |
| | | | R308600M02AL00 | Riflettore Reflector | 85,00 € |
| PALLINA |  | F443060150NENE | R440400V00BI00 | Diffusore Diffuser | 130,00 € |
| | | F443060150NSNE | R440400V00BI00 | Diffusore Diffuser | 130,00 € |
| | | F443060150OTNE | R440400V00BI00 | Diffusore Diffuser | 130,00 € |
| | | F443060150NSNE | R440400V00BI00 | Diffusore Diffuser | 130,00 € |
| PAROLA |  | F268945150AMNE | R265800V00AM00 | Diffusore Diffuser | 340,00 € |
| | | F268945150BINE | R265800V00BI00 | Diffusore Diffuser | 340,00 € |
| RIGA |  | F521440260AXLE | R521401V00OP00 | Diffusore Diffuser | 30,00 € |
| | | F521440260BILE | R521401V00OP00 | Diffusore Diffuser | 30,00 € |
| | | F521440260NSLE | R521401V00OP00 | Diffusore Diffuser | 30,00 € |
| |  | F539845260AXLE | R539800V00OP00 | Diffusore Diffuser | 30,00 € |
| | | F539845260NSLE | R539800V00OP00 | Diffusore Diffuser | 30,00 € |
| | | F539845250BILE | R539800V00OP00 | Diffusore Diffuser | 30,00 € |
| |  | F521450260AXLE | R521400V00OP00 | Diffusore Diffuser | 45,00 € |
| | | F521450260NSLE | R521400V00OP00 | Diffusore Diffuser | 45,00 € |
| | | F521450250BILE | R521400V00OP00 | Diffusore Diffuser | 45,00 € |
| SCINTILLA |  | FP15045250CRNE | RP15000V05TR00 | Schermo superiore Upper protection | 23,00 € |
| | | | RP15000V06TR00 | Schermo inferiore Lower protection | 23,00 € |
| | | | RS15000M02AL00 | Riflettore Reflector | 40,00 € |



| Famiglia Family | | Codice prodotto finito Product code | Codice ricambio Spare part code | Descrizione Description | Prezzo Retail con IVA Retail Price VAT incl. |
|--------------------|---|--|------------------------------------|---------------------------------------|---|
| | | FP15045250NSNE | RP15000V05TR00 | Schermo superiore Upper protection | 23,00 € |
| | | | RP15000V06TR00 | Schermo inferiore Lower protection | 23,00 € |
| | | | RS15000M02AL00 | Riflettore Reflector | 40,00 € |
| |  | FP30050250CRNE | RP30000V05TR00 | Schermo Superiore Upper Protection | 30,00 € |
| | | | RP30000V06TR00 | Schermo inferiore Lower protection | 30,00 € |
| | | | RS30000M02AL00 | Riflettore Reflector | 50,00 € |
| | | FP30050250NSNE | RP30000V05TR00 | Schermo superiore Upper protection | 30,00 € |
| | | | RP30000V06TR00 | Schermo inferiore Lower protection | 30,00 € |
| | | | RS30000M02AL00 | Riflettore Reflector | 50,00 € |
| SILLABA |  | F277560150BINE | R277500V00OP00 | Diffusore Diffuser | 90,00 € |
| |  | F277565150BINE | R277501V00OP00 | Diffusore Diffuser | 165,00 € |
| |  | F277570150BINE | R277502V00OP00 | Diffusore Diffuser | 165,00 € |
| | | F277570150BILE | R277502V00OP00 | Diffusore Diffuser | 165,00 € |
| SILLABONE |  | F279370150BINE | R279300V00OP00 | Diffusore Diffuser | 280,00 € |
| THEA |  | F444965550NFLE | R444985V00FU00 | Diffusore Diffuser | 500,00 € |
| | | F444965575RTLE | R444985V00TR00 | Diffusore Diffuser | 500,00 € |
| |  | F444970550NFLE | R444990V00FU00 | Diffusore Diffuser | 800,00 € |
| | | F444970575RTLE | R444990V00TR00 | Diffusore Diffuser | 800,00 € |
| TROPICO |  | F442160550NELE | R443100V00BI00 | Diffusore Diffuser | 265,00 € |
| | | F442160550OOLE | R443100V00BI00 | Diffusore Diffuser | 265,00 € |
| |  | F442165550NELE | R443101V00BI00 | Diffusore Diffuser | 355,00 € |
| | | F442165550OOLE | R443101V00BI00 | Diffusore Diffuser | 355,00 € |
| |  | F442170550NELE | R443102V00BI00 | Diffusore Diffuser | 475,00 € |
| | | F442170550OOLE | R443102V00BI00 | Diffusore Diffuser | 475,00 € |



LAMPADE A SOSPENSIONE SUSPENSION LAMPS

| Famiglia Family | | Codice prodotto finito Product code | Codice ricambio Spare part code | Descrizione Description | Prezzo Retail con IVA Retail Price VAT incl. |
|---|---|---|---|---|---|
| 0024 |  | F002485150TRNE | R002400V00TR00 | Set dischi diffusori Set glass disks | 1.325,00 € |
| AMAX |  | F544480350BINE | R544400V00BI00 | Diffusore Diffuser | 255,00 € |
| |  | F544485350BINE | R544401V00BI00 | Diffusore Diffuser | 320,00 € |
| |  | F544490350BINE | R544402V00BI00 | Diffusore Diffuser | 655,00 € |
| | | R556201K00CB00 | Kit disco chiusura Clousing disk kit | 445,00 € | |
|  | F544495350BINE | R544403V00BI00 | Diffusore Diffuser | 965,00 € | |
| | R556200K00CB00 | Kit disco chiusura Clousing disk kit | 545,00 € | | |
| BOLLA |  | | R356700V00TR00 | Diffusore Diffuser | 465,00 € |
| | | | R356701V00TR00 | Diffusore Diffuser | 620,00 € |
| AVICO |  | F556180350BINE | R556100V00BI00 | Diffusore bianco White diffuser | 900,00 € |
| | | | R556203K00CB00 | Kit disco chiusura Clousing disk kit | 545,00 € |
| |  | F556185350BINE | R556101V00BI00 | Diffusore bianco White diffuser | 1.105,00 € |
| | | | R556200K00CB00 | Kit disco chiusura Clousing disk kit | 545,00 € |
| EQUATORE |  | F439080150OOLE | R439000V00BR00 | Diffusore Diffuser | 450,00 € |
| | | F439080550NELE | R439000V00NE00 | Diffusore Diffuser | 450,00 € |
| | | F439080550RSLE | R439000V00RS00 | Diffusore Diffuser | 450,00 € |
| | | F439080550CRLE | R439000V00TR00 | Diffusore Diffuser | 450,00 € |

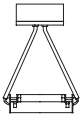
| Famiglia Family | | Codice prodotto finito Product code | Codice ricambio Spare part code | Descrizione Description | Prezzo Retail con IVA Retail Price VAT incl. |
|----------------------|---|--|------------------------------------|----------------------------|---|
| |  | F439085150OLE | R439001V00BR00 | Diffusore Diffuser | 580,00 € |
| | | F439085550NELE | R439001V00NE00 | Diffusore Diffuser | 580,00 € |
| | | F439085550RSLE | R439001V00RS00 | Diffusore Diffuser | 580,00 € |
| | | F439085550CRLE | R439001V00TR00 | Diffusore Diffuser | 580,00 € |
| |  | F439090150OLE | R439002V00BR00 | Diffusore Diffuser | 950,00 € |
| | | F439090550NELE | R439002V00NE00 | Diffusore Diffuser | 950,00 € |
| | | F439090550RSLE | R439002V00RS00 | Diffusore Diffuser | 950,00 € |
| | | F439090550CRLE | R439002V00TR00 | Diffusore Diffuser | 950,00 € |
| FLÛTE |  | F333780150TCNE | R333700V00TR00 | Diffusore Diffuser | 350,00 € |
| | | F333780550NENE | R333700V00TR00 | Diffusore Diffuser | 350,00 € |
| | | F333780550OTNE | R333700V00TR00 | Diffusore Diffuser | 350,00 € |
| |  | F333785150TCNE | R333700V00TR00 | Diffusore Diffuser | 350,00 € |
| | |  | F333790150TCNE | R333700V00TR00 | Diffusore Diffuser |
| GLOBO DI LUCE |  | | F364480150CRNE | R364400V00CR00 | Diffusore Diffuser |
| | | F364480150RMNE | R364400V00RM00 | Diffusore Diffuser | 345,00 € |
| |  | F364485150CRNEW | R364402V00CR00 | Diffusore Diffuser | 475,00 € |
| | | F364485150RMNE | R364402V00RM00 | Diffusore Diffuser | 505,00 € |
| |  | F364490150CRNE | R364401V00CR00 | Diffusore Diffuser | 755,00 € |
| | | F364490150RMNE | R364401V00RM00 | Diffusore Diffuser | 780,00 € |
| MERIDIANO |  | F441785550NFLE | R441700V00NE00 | Diffusore Diffuser | 735,00 € |
| | | F441785550NRLE | R441700V00RS00 | Diffusore Diffuser | 735,00 € |
| | | F441785550NTLE | R441700V00TR00 | Diffusore Diffuser | 735,00 € |

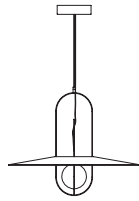
| Famiglia Family | Codice prodotto finito Product code | Codice ricambio Spare part code | Descrizione Description | Prezzo Retail con IVA Retail Price VAT incl. | |
|---|---|------------------------------------|----------------------------|--|----------|
|  | F441790550NFLE | R441701V00NE00 | Diffusore Diffuser | 1.175,00 € | |
| | F441790550NRLE | R441701V00RS00 | Diffusore Diffuser | 1.175,00 € | |
| | F441790550NTLE | R441701V00TR00 | Diffusore Diffuser | 1.175,00 € | |
| PALLINA |  | F443080150NENE | R440400V00BI00 | Diffusore in vetro con ghiera Diffuser with metal ring | 130,00 € |
| | | F443080150NSNE | R440400V00BI00 | Diffusore in vetro con ghiera Diffuser with metal ring | 130,00 € |
| | | F443080150OTNE | R440400V00BI00 | Diffusore in vetro con ghiera Diffuser with metal ring | 130,00 € |
| | | F443080150ORNE | R440400V00BI00 | Diffusore in vetro con ghiera Diffuser with metal ring | 130,00 € |
| PAROLA |  | F428485100AMNE | R428400V00AM00 | Diffusore Diffuser | 345,00 € |
| | | F428485100BINE | R428400V00BI00 | Diffusore Diffuser | 345,00 € |
| SCINTILLA |  | FS15085250CRNE | RP15000V05TR00 | Vetro protezione superiore trasparente Upper transparent protection glass | 23,00 € |
| | | | RP15000V06TR00 | Vetro protezione inferiore trasparente Lower transparent protection glass | 23,00 € |
| | | | RP15000V05OP00 | Vetro protezione superiore sabbiato Upper sandblasted protection glass | 23,00 € |
| | | | RP30001V06OP00 | Vetro protezione inferiore sabbiato Lower sandblasted protection glass | 23,00 € |
| | | | RP30000M03AX00 | Molla fissaggio vetro inferiore Lower protection glass spring holder | 7,00 € |
| | | | RP15000M03AX00 | Molla fissaggio vetro superiore Upper protection glass spring holder | 7,00 € |
| | | | RS15000M02AL00 | Riflettore Reflector | 40,00 € |
| | | FS15085250NSNE | RP15000V05TR00 | Vetro protezione superiore trasparente Upper transparent protection glass | 23,00 € |
| | | | RP15000V06TR00 | Vetro protezione inferiore trasparente Lower transparent protection glass | 23,00 € |
| | | | RP15000V05OP00 | Vetro protezione superiore sabbiato Upper sandblasted protection glass | 23,00 € |
| | | | RP30001V06OP00 | Vetro protezione inferiore sabbiato Lower sandblasted protection glass | 23,00 € |
| | | | RP30000M03AX00 | Molla fissaggio vetro inferiore Lower protection glass spring holder | 7,00 € |
| | | | RP15000M03AX00 | Molla fissaggio vetro superiore Upper protection glass spring holder | 7,00 € |
| | | | RS15000M02AL00 | Riflettore Reflector | 40,00 € |

| Famiglia Family | Codice prodotto finito Product code | Codice ricambio Spare part code | Descrizione Description | Prezzo Retail con IVA Retail Price VAT incl. | |
|---|---|------------------------------------|--|---|----------|
|  | FS30090250CRNE | RP30000V05TR00 | Vetro protezione superiore trasparente Upper transparent protection glass | 30,00 € | |
| | | RP30000V06TR00 | Vetro protezione inferiore trasparente Lower transparent protection glass | 30,00 € | |
| | | R279100V05OP00 | Vetro protezione superiore sabbiato Upper sandblasted protection glass | 35,00 € | |
| | | RP30000V06OP00 | Vetro protezione inferiore sabbiato Lower sandblasted protection glass | 35,00 € | |
| | | RP30000M03AX00 | Molla fissaggio vetro inferiore Lower protection glass spring holder | 7,00 € | |
| | | RP15000M03AX00 | Molla fissaggio vetro superiore Upper protection glass spring holder | 7,00 € | |
| | | RS30000M02AL00 | Riflettore Reflector | 50,00 € | |
| | FS30090250NSNE | RP30000V05TR00 | Vetro protezione superiore trasparente Upper transparent protection glass | 30,00 € | |
| | | RP30000V06TR00 | Vetro protezione inferiore trasparente Lower transparent protection glass | 30,00 € | |
| | | R279100V05OP00 | Vetro protezione superiore sabbiato Upper sandblasted protection glass | 35,00 € | |
| | | RP30000V06OP00 | Vetro protezione inferiore sabbiato Lower sandblasted protection glass | 35,00 € | |
| | | RP30000M03AX00 | Molla fissaggio vetro inferiore Lower protection glass spring holder | 7,00 € | |
| | | RP15000M03AX00 | Molla fissaggio vetro superiore Upper protection glass spring holder | 7,00 € | |
| | | RS30000M02AL00 | Riflettore Reflector | 50,00 € | |
| SETAREH |  | F438G80550NBLE | R438G00V00BI00 | Diffusore Diffuser | 160,00 € |
| | | | R440400V00BI00 | Diffusore in vetro con ghiera Diffuser with metal ring | 130,00 € |
| | | F438G80550OBLE | R438G00V00BI00 | Diffusore Diffuser | 160,00 € |
| | | | R440400V00BI00 | Diffusore in vetro con ghiera Diffuser with metal ring | 130,00 € |
| |  | F438G85550NBLE | R438G01V00BI00 | Diffusore Diffuser | 240,00 € |
| | | | R440400V00BI00 | Diffusore in vetro con ghiera Diffuser with metal ring | 130,00 € |
| | | F438G85550OBLE | R438G01V00BI00 | Diffusore Diffuser | 240,00 € |
| | | | R440400V00BI00 | Diffusore in vetro con ghiera Diffuser with metal ring | 130,00 € |
| |  | F438G90550NBLE | R438G02V00BI00 | Diffusore Diffuser | 325,00 € |
| | | | R440400V00BI00 | Diffusore in vetro con ghiera Diffuser with metal ring | 130,00 € |
| | | F438G90550OBLE | R438G02V00BI00 | Diffusore Diffuser | 325,00 € |
| | | | R440400V00BI00 | Diffusore in vetro con ghiera Diffuser with metal ring | 130,00 € |

| Famiglia Family | | Codice prodotto finito Product code | Codice ricambio Spare part code | Descrizione Description | Prezzo Retail con IVA Retail Price VAT incl. |
|--------------------|---|--|------------------------------------|----------------------------|---|
| THEA |  | F444985550NFLE | R444985V00FU00 | Diffusore Diffuser | 500,00 € |
| | | F444985575RTLE | R444985V00TR00 | Diffusore Diffuser | 500,00 € |
| |  | F444990550NFLE | R444990V00FU00 | Diffusore Diffuser | 800,00 € |
| | | F444990575RTLE | R444990V00TR00 | Diffusore Diffuser | 800,00 € |

ARREDO FURNITURE

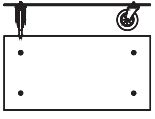
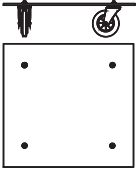
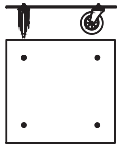
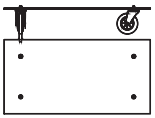
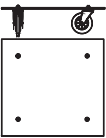
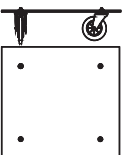
| TAVOLO CON RUOTE | | | | | |
|---|----------------|----------------|--|------------|--|
|  | F1000TB150TR00 | R265200V07TR00 | Piano vetro 140x70 Glass top 140x70 | 770,00 € | |
| | | R265200M10NE00 | Set ruote Set of wheels | 890,00 € | |
|  | F1140TB150TR40 | R265300V07TR00 | Piano vetro 150x150 Glass top 150x150 | 1.475,00 € | |
| | | R265200M10NE00 | Set ruote Set of wheels | 890,00 € | |
|  | F1130TB150TR30 | R274400V07TR00 | Piano vetro 120x120 Glass top 120x120 | 1.075,00 € | |
| | | R265200M10NE00 | Set ruote Set of wheels | 890,00 € | |
|  | F1010TB150TR10 | R274600V07TR00 | Piano vetro 100x150 Glass top 100x150 | 1.085,00 € | |
| | | R265200M10NE00 | Set ruote Set of wheels | 890,00 € | |
|  | F1110TB150TR00 | R274401V07TR00 | Piano vetro 100x100 Glass top 100x100 | 770,00 € | |
| | | R265200M10NE00 | Set ruote Set of wheels | 890,00 € | |
|  | F1120TB150TR20 | R274402V07TR00 | Piano vetro 110x110 Glass top 110x110 | 1.065,00 € | |
| | | R265200M10NE00 | Set ruote Set of wheels | 890,00 € | |

MISURE E PESI DELL'IMBALLO / PACKAGING MEASUREMENTS AND WEIGHT

LAMPADE DA TAVOLO TABLE LAMPS



| Famiglia Family | Codice Code | Descrizione Description | Dimensione Size cm A x B x H | Kg netto Kg net | Kg lordo Kg gross | |
|--------------------|----------------|--|--|----------------------|----------------------|------------|
| 3247 | F324700150KBNE | DIFFUSORE / DIFFUSER MONTATURA / MOUNTING | 27x27x27 28x43x28 | 1 1,4 | 2 3 | |
| | F324710150KBNE | DIFFUSORE / DIFFUSER MONTATURA / MOUNTING | 42x37x42 44x54x44 | 0,7 4 | 1,2 6 | |
| ASHANGAI | F418805150CBNE | LAMPADA COMPLETA / COMPLETE LAMP | 60x90x60 | 6 | 14 | |
| BIANCA | F430800150BILE | LAMPADA COMPLETA / COMPLETE LAMP | 21x16x21 | 1 | 1,2 | |
| | F430805150BILE | LAMPADA COMPLETA / COMPLETE LAMP | 40x27,5x40 | 3 | 3,3 | |
| | F430810150BINE | LAMPADA COMPLETA / COMPLETE LAMP | 61x57x61 | 6 | 8,5 | |
| BILIA MINI | F247400150BINE | LAMPADA COMPLETA / COMPLETE LAMP | 19,5x31x19,5 | 0,6 | 0,9 | |
| | F247400150BLNE | LAMPADA COMPLETA / COMPLETE LAMP | 19,5x31x19,5 | 0,6 | 0,9 | |
| | F247400150GINE | LAMPADA COMPLETA / COMPLETE LAMP | 19,5x31x19,5 | 0,6 | 0,9 | |
| | F247400150KBNE | LAMPADA COMPLETA / COMPLETE LAMP | 19,5x31x19,5 | 0,6 | 0,9 | |
| | F247400150NENE | LAMPADA COMPLETA / COMPLETE LAMP | 19,5x31x19,5 | 0,6 | 0,9 | |
| | F247400150RONE | LAMPADA COMPLETA / COMPLETE LAMP | 19,5x31x19,5 | 0,6 | 0,9 | |
| | F247400150TBNE | LAMPADA COMPLETA / COMPLETE LAMP | 19,5x31x19,5 | 0,6 | 0,9 | |
| | F247400150VENE | LAMPADA COMPLETA / COMPLETE LAMP | 19,5x31x19,5 | 0,6 | 0,9 | |
| | F247400550NENE | LAMPADA COMPLETA / COMPLETE LAMP | 19,5x31x19,5 | 0,6 | 0,9 | |
| | F247400550RSNE | LAMPADA COMPLETA / COMPLETE LAMP | 19,5x31x19,5 | 0,6 | 0,9 | |
| | BILIA | F247405150KBNE | DIFFUSORE / DIFFUSER MONTATURA / MOUNTING | 28x30x28 18x37x18 | 1 0,8 | 1,5 1,6 |
| | | F247405150TBNE | DIFFUSORE / DIFFUSER MONTATURA / MOUNTING | 28x30x28 18x37x18 | 1 0,8 | 1,5 1,6 |
| | | F247405550NENE | DIFFUSORE / DIFFUSER MONTATURA / MOUNTING | 28x30x28 18x37x18 | 1 0,8 | 1,5 1,6 |
| F247405550RSNE | | DIFFUSORE / DIFFUSER MONTATURA / MOUNTING | 28x30x28 18x37x18 | 1 0,8 | 1,5 1,6 | |
| BIS - TRIS | | F228005150CBNE | LAMPADA COMPLETA / COMPLETE LAMP | 46x54x46 | 6,6 | 9,4 |
| | F228005150TNNE | LAMPADA COMPLETA / COMPLETE LAMP | 46x54x46 | 6,6 | 9,4 | |
| BLOM | F425305350BINE | LAMPADA COMPLETA / COMPLETE LAMP | 29x37x29 | 1 | 2 | |
| | F425305350BLNE | LAMPADA COMPLETA / COMPLETE LAMP | 29x37x29 | 1 | 2 | |
| | F425305350GINE | LAMPADA COMPLETA / COMPLETE LAMP | 29x37x29 | 1 | 2 | |
| | F425305350GSNE | LAMPADA COMPLETA / COMPLETE LAMP | 29x37x29 | 1 | 2 | |
| | F425305350RSNE | LAMPADA COMPLETA / COMPLETE LAMP | 29x37x29 | 1 | 2 | |
| | F425305350VENE | LAMPADA COMPLETA / COMPLETE LAMP | 29x37x29 | 1 | 2 | |
| | F425305350VINE | LAMPADA COMPLETA / COMPLETE LAMP | 29x37x29 | 1 | 2 | |
| CHESHIRE | F425105350BINE | LAMPADA COMPLETA / COMPLETE LAMP | 45,5x74x45,5 | 6,3 | 9,8 | |
| | F425105350NENE | LAMPADA COMPLETA / COMPLETE LAMP | 45,5x74x45,5 | 6,3 | 9,3 | |

| Famiglia Family | Codice Code | Descrizione Description | Dimensione Size cm A x B x H | Kg netto Kg net | Kg lordo Kg gross |
|--------------------|----------------|--|--|----------------------|----------------------|
| DARUMA | F502800100BINE | LAMPADA COMPLETA / COMPLETE LAMP | 19x26x19 | 1 | 1,5 |
| | F502805100BINE | LAMPADA COMPLETA / COMPLETE LAMP | 31x41x31 | 2,2 | 3 |
| | F502810100BINE | LAMPADA COMPLETA / COMPLETE LAMP | 44x55x44 | 5,8 | 7,8 |
| EQUATORE | F438900150OOWL | DIFFUSORE / DIFFUSER MONTATURA / MOUNTING | 32x22,5x32 32x41x32 | 1,7 5,2 | 2,5 6,2 |
| | F438900550CRWL | DIFFUSORE / DIFFUSER MONTATURA / MOUNTING | 32x22,5x32 32x41x32 | 1,7 5,2 | 2,5 6,2 |
| | F438900550NEWL | DIFFUSORE / DIFFUSER MONTATURA / MOUNTING | 32x22,5x32 32x41x32 | 1,7 5,2 | 2,5 6,2 |
| | F438900550RSWL | DIFFUSORE / DIFFUSER MONTATURA / MOUNTING | 32x22,5x32 32x41x32 | 1,7 5,2 | 2,5 6,2 |
| | F438905150OOWL | DIFFUSORE / DIFFUSER MONTATURA / MOUNTING | 43x33,5x43 43x50x43 | 3,4 13 | 5,3 15 |
| | F438905550CRWL | DIFFUSORE / DIFFUSER MONTATURA / MOUNTING | 43x33,5x43 43x50x43 | 3,4 13 | 5,3 15 |
| | F438905550NEWL | DIFFUSORE / DIFFUSER MONTATURA / MOUNTING | 43x33,5x43 43x50x43 | 3,4 13 | 5,3 15 |
| | F438905550RSWL | DIFFUSORE / DIFFUSER MONTATURA / MOUNTING | 43x33,5x43 43x50x43 | 3,4 13 | 5,3 15 |
| | FALENA | F301705150CRNE | CORPO / BODY BASE / BASE | 70x10x30 27x17x27 | 0,2 1,3 |
| FONTANA | | F185300100BINE | DIFFUSORE / DIFFUSER MONTATURA / MOUNTING | 27x27x27 25x25x30 | 0,7 1 |
| | F185300200OTNE | DIFFUSORE / DIFFUSER MONTATURA / MOUNTING | 27x27x27 25x25x30 | 0,7 2 | 1,2 2 |
| | F185305100BINE | DIFFUSORE / DIFFUSER MONTATURA / MOUNTING | 42x37x42 35x45x40 | 1 3 | 2 4 |
| | F185305200OTNE | DIFFUSORE / DIFFUSER MONTATURA / MOUNTING | 42x37x42 55x55x85 | 1 2 | 2 2 |
| | F185310100BINE | DIFFUSORE / DIFFUSER MONTATURA / MOUNTING | 54x52x54 55x55x85 | 4,8 7 | 7 8 |
| FONTANELLA | F442305550CRNE | DIFFUSORE / DIFFUSER MONTATURA / MOUNTING | 32,5x32,5x37,5 15x15x11 | 0,5 1,5 | 1 2 |
| | F442305550NENE | DIFFUSORE / DIFFUSER MONTATURA / MOUNTING | 32,5x32,5x37,5 15x15x11 | 0,5 1,5 | 1 2 |
| | F442305550OTNE | DIFFUSORE / DIFFUSER MONTATURA / MOUNTING | 32,5x32,5x37,5 15x15x11 | 0,5 1,5 | 1 2 |
| | F442310550CRNE | DIFFUSORE / DIFFUSER MONTATURA / MOUNTING | 32,5x32,5x37,5 15x15x11 | 0,5 1,5 | 1 2 |
| | F442310550NENE | DIFFUSORE / DIFFUSER MONTATURA / MOUNTING | 32,5x32,5x37,5 15x15x11 | 0,5 1,5 | 1 2 |
| | F442310550OTNE | DIFFUSORE / DIFFUSER MONTATURA / MOUNTING | 32,5x32,5x37,5 15x15x11 | 0,5 1,5 | 1 2 |
| GIOVA | F268405150CRNE | LAMPADA COMPLETA / COMPLETE LAMP | 41x78x41 | 5 | 7 |
| | F268405575OONE | LAMPADA COMPLETA / COMPLETE LAMP | 41x78x41 | 5 | 7 |
| | F268410150CRNE | LAMPADA COMPLETA / COMPLETE LAMP | 56x83x56 | 14 | 17,5 |
| | F268410575OONE | LAMPADA COMPLETA / COMPLETE LAMP | 56x83x56 | 14 | 17,5 |
| KINX | F431205200NEWL | LAMPADA COMPLETA / COMPLETE LAMP | 22x47,5x77,5 | 2,5 | 4 |
| LASOSPESA | F443105150TRWL | LAMPADA COMPLETA / COMPLETE LAMP | 20x45x20 | 0,5 | 2,5 |
| LOOP | F542910200AXLE | LAMPADA COMPLETA / COMPLETE LAMP | 55x26x55 | 8,5 | 10 |
| MANO | F420805400NELE | MONTATURA / MOUNTING DIFFUSORE / DIFFUSER | 28x48x26 42x41x42 | 3 0,3 | 4 1,5 |

| Famiglia Family | Codice Code | Descrizione Description | Dimensione Size cm A x B x H | Kg netto Kg net | Kg lordo Kg gross |
|--------------------------------|------------------|--------------------------------|---------------------------------|--------------------|----------------------|
| MATRIX | F444305250BIWL | GABBIA INFERIORE / LOWER CAGE | 32x32x23,5 | 2,8 | 3,7 |
| | | GABBIA SUPERIORE / UPPER CAGE | 32x32x23,5 | 2,8 | 3,7 |
| | | DIFFUSORE / DIFFUSER | 30x30x32 | 1,6 | 2,5 |
| | F444305250OBWL | GABBIA INFERIORE / LOWER CAGE | 32x32x23,5 | 2,8 | 3,7 |
| | | GABBIA SUPERIORE / UPPER CAGE | 32x32x23,5 | 2,8 | 3,7 |
| | | DIFFUSORE / DIFFUSER | 30x30x32 | 1,6 | 2,5 |
| | F444310250OBWL | GABBIA INFERIORE / LOWER CAGE | 32x32x23,5 | 2,8 | 3,7 |
| | | GABBIA CENTRALE / CENTRAL CAGE | 32x32x23,5 | 2,8 | 3,7 |
| | | GABBIA CENTRALE / CENTRAL CAGE | 32x32x23,5 | 2,8 | 3,7 |
| | | GABBIA SUPERIORE / UPPER CAGE | 32x32x23,5 | 2,8 | 3,7 |
| | | DIFFUSORE / DIFFUSER | 30x30x32 | 1,6 | 2,5 |
| | F444310250OBWL | GABBIA INFERIORE / LOWER CAGE | 32x32x23,5 | 2,8 | 3,7 |
| GABBIA CENTRALE / CENTRAL CAGE | | 32x32x23,5 | 2,8 | 3,7 | |
| GABBIA CENTRALE / CENTRAL CAGE | | 32x32x23,5 | 2,8 | 3,7 | |
| GABBIA SUPERIORE / UPPER CAGE | | 32x32x23,5 | 2,8 | 3,7 | |
| DIFFUSORE / DIFFUSER | | 30x30x32 | 1,6 | 2,5 | |
| MERIDIANO | F441705550NFWL | DIFFUSORE / DIFFUSER | 39x39x49 | 2,8 | 4,8 |
| | | MONTATURA / MOUNTING | 28x29,5x52,5 | 2,7 | 4,2 |
| | F441705550NRWL | DIFFUSORE / DIFFUSER | 39x39x49 | 2,8 | 4,8 |
| | | MONTATURA / MOUNTING | 28x29,5x52,5 | 2,7 | 4,2 |
| | F441705550NTWL | DIFFUSORE / DIFFUSER | 39x39x49 | 2,8 | 4,8 |
| | | MONTATURA / MOUNTING | 28x29,5x52,5 | 2,7 | 4,2 |
| METAFORA | F265405150BTNE | MONTATURA / MOUNTING | 52x46x52 | 5,5 | 6,5 |
| | | DIFFUSORE / DIFFUSER | 52x32x52 | 5 | 6 |
| NASKA | F810010200BINE | CORPO / BODY | 18x67x28 | 2,8 | 3,5 |
| | | BASE / BASE | 29x21x29 | 6,6 | 7,2 |
| | F810010200BIWL | CORPO / BODY | 18x67x28 | 2,8 | 3,5 |
| | | BASE / BASE | 29x21x29 | 6,6 | 7,2 |
| | F810010200NENE | CORPO / BODY | 18x67x28 | 2,8 | 3,5 |
| | | BASE / BASE | 29x21x29 | 6,6 | 7,2 |
| | F810010200NEWL | CORPO / BODY | 18x67x28 | 2,8 | 3,5 |
| | | BASE / BASE | 29x21x29 | 6,6 | 7,2 |
| | F810010240CRNE | CORPO / BODY | 18x67x28 | 2,8 | 3,5 |
| | | BASE / BASE | 29x21x29 | 6,6 | 7,2 |
| | F810010240CRWL | CORPO / BODY | 18x67x28 | 2,8 | 3,5 |
| | | BASE / BASE | 29x21x29 | 6,6 | 7,2 |
| | F810010240OOWL | CORPO / BODY | 18x67x28 | 2,8 | 3,5 |
| | | BASE / BASE | 29x21x29 | 6,6 | 7,2 |
| | F810100200BINE | CORPO / BODY | 23x38x20 | 1,9 | 2,5 |
| | | MORSETTO / CLAMP | 15x9x13 | 0,1 | 0,2 |
| | F810100200NENE | CORPO / BODY | 23x38x20 | 1,9 | 2,5 |
| | | MORSETTO / CLAMP | 15x9x13 | 0,1 | 0,2 |
| | F810100240CRNE | CORPO / BODY | 23x38x20 | 1,9 | 2,5 |
| | | MORSETTO / CLAMP | 15x9x13 | 0,1 | 0,2 |
| | F810110200BINE | CORPO / BODY | 18x67x28 | 2,8 | 3,5 |
| | | MORSETTO / CLAMP | 15x9x13 | 0,1 | 0,2 |
| | F810110200BIWL | CORPO / BODY | 18x67x28 | 2,8 | 3,5 |
| | | MORSETTO / CLAMP | 15x9x13 | 0,1 | 0,2 |
| F810110200NENE | CORPO / BODY | 18x67x28 | 2,8 | 3,5 | |
| | MORSETTO / CLAMP | 15x9x13 | 0,1 | 0,2 | |
| F810110200NEWL | CORPO / BODY | 18x67x28 | 2,8 | 3,5 | |
| | MORSETTO / CLAMP | 15x9x13 | 0,1 | 0,2 | |
| F810110240CRNE | CORPO / BODY | 18x67x28 | 2,8 | 3,5 | |
| | MORSETTO / CLAMP | 15x9x13 | 0,1 | 0,2 | |
| F810110240CRWL | CORPO / BODY | 18x67x28 | 2,8 | 3,5 | |
| | MORSETTO / CLAMP | 15x9x13 | 0,1 | 0,2 | |

| Famiglia Family | Codice Code | Descrizione Description | Dimensione Size cm A x B x H | Kg netto Kg net | Kg lordo Kg gross |
|--------------------|----------------|--|--|--------------------|----------------------|
| | F810110240OOWL | CORPO / BODY MORSETTO / CLAMP | 18x67x28 15x9x13 | 2,8 0,1 | 3,5 0,2 |
| | F810700200BINE | CORPO / BODY BASE / BASE | 23x38x20 26x21x26 | 1,9 3 | 2,5 3,5 |
| | F810700200NENE | CORPO / BODY BASE / BASE | 23x38x20 26x21x26 | 1,9 3 | 2,5 3,5 |
| | F810700240CRNE | CORPO / BODY BASE / BASE | 23x38x20 26x21x26 | 1,9 3 | 2,5 3,5 |
| OORT | OORT00020 | LAMPADA COMPLETA / COMPLETE LAMP | 41x41x46 | 5,5 | 7,5 |
| | OORT00021 | LAMPADA COMPLETA / COMPLETE LAMP | 41x41x46 | 5,5 | 7,5 |
| PALLINA | F443000150NENE | LAMPADA COMPLETA / COMPLETE LAMP | 19x19x19 | 1 | 1,5 |
| | F443000150NSNE | LAMPADA COMPLETA / COMPLETE LAMP | 19x19x19 | 1 | 1,5 |
| | F443000150ORNE | LAMPADA COMPLETA / COMPLETE LAMP | 19x19x19 | 1 | 1,5 |
| | F443000150OTNE | LAMPADA COMPLETA / COMPLETE LAMP | 19x19x19 | 1 | 1,5 |
| PAROLA | F265805100AMNE | MONTATURA / MOUNTING DIFFUSORE / DIFFUSER | 54x29x27 34,5x27x34,5 | 1 0,6 | 2,2 1,4 |
| | F265805100BINE | MONTATURA / MOUNTING DIFFUSORE / DIFFUSER | 54x29x27 34,5x27x34,5 | 1 0,6 | 2,2 1,4 |
| PASSION | F361000150CRNE | MONTATURA / MOUNTING DIFFUSORE / DIFFUSER | 25x43x25 25x19,5x25 | 2 0,6 | 2,6 1,2 |
| | F361000150NCNE | MONTATURA / MOUNTING DIFFUSORE / DIFFUSER | 25x43x25 25x19,5x25 | 2 0,6 | 2,6 1,2 |
| | F361005150CRNE | MONTATURA / MOUNTING DIFFUSORE / DIFFUSER | 33,1x64,1x33,1 37x26x37 | 4,5 1,5 | 5,51 2,2 |
| | F361005150NCNE | MONTATURA / MOUNTING DIFFUSORE / DIFFUSER | 33,1x64,1x33,1 37x26x37 | 4,5 1,5 | 5,51 2,2 |
| PINECONE | F436405550CBNE | LAMPADA COMPLETA / COMPLETE LAMP | 40x40x40 | 5,5 | 6,5 |
| | F436405550TCNE | LAMPADA COMPLETA / COMPLETE LAMP | 40x40x40 | 5,5 | 6,5 |
| | F436405575OBNE | LAMPADA COMPLETA / COMPLETE LAMP | 40x40x40 | 5,5 | 6,5 |
| | F436405575TONE | LAMPADA COMPLETA / COMPLETE LAMP | 40x40x40 | 5,5 | 6,5 |
| | F434010550CBNE | LAMPADA COMPLETA / COMPLETE LAMP | 64x58x64 | 11 | 14 |
| | F434010550TCNE | LAMPADA COMPLETA / COMPLETE LAMP | 64x58x64 | 11 | 14 |
| | F434010575OBNE | LAMPADA COMPLETA / COMPLETE LAMP | 64x58x64 | 11 | 14 |
| | F434010575TONE | LAMPADA COMPLETA / COMPLETE LAMP | 64x58x64 | 11 | 14 |
| PIRELLINA | F278205150KBNE | MONTATURA / MOUNTING DIFFUSORI / DIFFUSERS | 21x10x43 32x16x34 | 1 1 | 1,4 1,4 |
| RE | F443810100BIWL | MONTATURA / MOUNTING DIFFUSORE / DIFFUSER | 41,5x41,5x72 35,5x38,5x35,5 | 8 2 | 9,5 3 |
| REGINA | F443710100BIWL | MONTATURA / MOUNTING DIFFUSORI / DIFFUSERS DIFFUSORE CENTRALE/CENTRAL DIFFUSER | 37,5x37,5x46 29x29x24,5 57x57x18,5 | 5,5 1 2,5 | 6,5 2 4,5 |
| SETAREH | F440105500NBWL | LAMPADA COMPLETA / COMPLETE LAMP | 50,5x52x55 | 3 | 4,5 |
| | F440105500OBWL | LAMPADA COMPLETA / COMPLETE LAMP | 50,5x52x55 | 3 | 4,5 |
| | F438405500NBWL | MONTATURA / MOUNTING DIFFUSORE / DIFFUSER | 27,5x80x36,5 50,5x8,5x50,5 | 3 0,9 | 4,5 2 |
| | F438405500OBWL | MONTATURA / MOUNTING DIFFUSORE / DIFFUSER | 27,5x80x36,5 50,5x8,5x50,5 | 3 0,9 | 4,5 2 |
| THEA | F444905550NFWL | MONTATURA / MOUNTING DIFFUSORE / DIFFUSER | 22x22x44,5 28,7,5x28,7x24 | 3,1 1,1 | 4 1,8 |
| | F444905575RTWL | MONTATURA / MOUNTING DIFFUSORE / DIFFUSER | 22x22x44,5 28,7,5x28,7x24 | 3,1 1,1 | 4 1,8 |

| Famiglia Family | Codice Code | Descrizione Description | Dimensione Size cm A x B x H | Kg netto Kg net | Kg lordo Kg gross |
|-------------------------|----------------|--|----------------------------------|--------------------|----------------------|
| | F444910550NFWL | MONTATURA / MOUNTING DIFFUSORE / DIFFUSER | 37,5x37,5x58,8 42,5x42,5x33,5 | 8,7 2,5 | 10,5 ,2 |
| | F444910575RTWL | MONTATURA / MOUNTING DIFFUSORE / DIFFUSER | 37,5x37,5x58,8 42,5x42,5x33,5 | 8,7 2,5 | 10,5 4,2 |
| THOR | F329500100BINE | LAMPADA COMPLETA / COMPLETE LAMP | 40x21x29 | 1,5 | 2 |
| | F329505100BINE | LAMPADA COMPLETA / COMPLETE LAMP | 47x23x32 | 2 | 2,8 |
| TROPICO | F442105585BIWL | MONTATURA / MOUNTING DIFFUSORE / DIFFUSER | 35x35x42 44x44x21 | 8,7 2 | 10,5 3,2 |
| | F442105585GCWL | MONTATURA / MOUNTING DIFFUSORE / DIFFUSER | 35x35x42 44x44x21 | 8,7 2 | 10,5 3,2 |
| | F442105585NEWL | MONTATURA / MOUNTING DIFFUSORE / DIFFUSER | 35x35x42 44x44x21 | 8,7 2 | 10,5 3,2 |
| | F442110585BIWL | MONTATURA / MOUNTING DIFFUSORE / DIFFUSER | 47x47x48,5 56x56x21 | 19,5 3,5 | 23,5 5,5 |
| | F442110585GCWL | MONTATURA / MOUNTING DIFFUSORE / DIFFUSER | 47x47x48,5 56x56x21 | 19,5 3,5 | 23,5 5,5 |
| | F442110585NEWL | MONTATURA / MOUNTING DIFFUSORE / DIFFUSER | 47x47x48,5 56x56x21 | 19,5 3,5 | 23,5 5,5 |
| UOVO | F264600100BINE | MONTATURA / MOUNTING DIFFUSORE / DIFFUSER | 15x10x15 24x40x24 | 0,2 1 | 0,3 1,5 |
| | F264605100BINE | MONTATURA / MOUNTING DIFFUSORE / DIFFUSER | 15x10x15 42x50x42 | 0,2 2 | 0,3 4 |
| | F264610100BINE | MONTATURA / MOUNTING DIFFUSORE / DIFFUSER | 20x15x20 49x68x49 | 0,4 5,2 | 0,6 8,2 |
| UOVO RIC. / REC. | F264600150BIBW | MONTATURA / MOUNTING DIFFUSORE / DIFFUSER | 15x10x15 24x40x24 | 0,2 1 | 0,3 1,5 |
| UOVO OUTDOOR | F264613370BINE | MONTATURA / MOUNTING DIFFUSORE / DIFFUSER | 20x15x20 55x55x85 | 0,4 4,2 | 0,6 6 |
| DEMI VOLÉE | F429000350BIWL | CORPO / BODY BASE / BASE | 26x6x64 27x8x27 | 0,5 3 | 1 3,5 |
| | F429000350GIWL | CORPO / BODY BASE / BASE | 26x6x64 27x8x27 | 0,6 3 | 1 3,5 |
| | F429000350GSWL | CORPO / BODY BASE / BASE | 26x6x64 27x8x27 | 0,6 3 | 1 3,5 |
| VOLÉE | F429005350BIWL | CORPO / BODY BASE / BASE | 108x7x28 27x8x27 | 3 3 | 3,5 3,5 |
| | F429005350GIWL | CORPO / BODY BASE / BASE | 108x7x28 27x8x27 | 3 3 | 3,5 3,5 |
| | F429005350GSWL | CORPO / BODY BASE / BASE | 108x7x28 27x8x27 | 3 3 | 3,5 3,5 |

LAMPADE DA TERRA FLOOR LAMPS



| Famiglia Family | Codice Code | Descrizione Description | Dimensione Size cm A x B x H | Kg netto Kg net | Kg lordo Kg gross |
|----------------------|----------------------|----------------------------------|---------------------------------|--------------------|----------------------|
| 0024 | F002430150TRNE | MONTATURA / MOUNTING | 48x200x48 | 26 | 28 |
| | | DIFFUSORE / DIFFUSER | 61x21x61 | 15,5 | 17,3 |
| 3247 | F324725150KBNE | MONTATURA / MOUNTING | 43x145x44 | 4,5 | 9,5 |
| | | DIFFUSORE / DIFFUSER | 42x37x42 | 0,7 | 1,2 |
| | F324730150KBNE | MONTATURA / MOUNTING | 52x186x56 | 15 | 23 |
| | | DIFFUSORE / DIFFUSER | 54x52x54 | 4,8 | 7 |
| ALICANTO | F443630160OBWL | DIFFUSORE / DIFFUSER | 39x39x40 | 2,7 | 4,2 |
| | | CORPO / BOBY | 62x146x65 | 10 | 20 |
| | | STELO / STEM | 79x240x39 | 3,5 | 14 |
| | | BASE / BASE | 54x19x22 | 30 | 31,2 |
| | F443630160ONWL | DIFFUSORE / DIFFUSER | 39x39x40 | 2,7 | 4,2 |
| | | CORPO / BOBY | 62x146x65 | 10 | 20 |
| | | STELO / STEM | 79x240x39 | 3,5 | 14 |
| | | BASE / BASE | 54x19x22 | 30 | 31,2 |
| BIANCA | F430930150BINE | MONTATURA / MOUNTING | 48x159x48 | 13,6 | 18,6 |
| | | DIFFUSORE / DIFFUSER | 61x57x61 | 5 | 7,5 |
| CHESHIRE | F425225350BINE | LAMPADA COMPLETA / COMPLETE LAMP | 50x163x49 | 6,6 | 13,3 |
| | F425225350NENE | LAMPADA COMPLETA / COMPLETE LAMP | 50x163x49 | 6,7 | 13,4 |
| EQUATORE | F439220150OOWL | MONTATURA / MOUNTING | 31,5x31,5x132 | 9,5 | 12 |
| | | DIFFUSORE / DIFFUSER | 32x22,5x32 | 1,7 | 2,5 |
| | F439220550CRWL | MONTATURA / MOUNTING | 31,5x31,5x132 | 9,5 | 12 |
| | | DIFFUSORE / DIFFUSER | 32x22,5x32 | 1,7 | 2,5 |
| | F439220550NEWL | MONTATURA / MOUNTING | 31,5x31,5x132 | 9,5 | 12 |
| | | DIFFUSORE / DIFFUSER | 32x22,5x32 | 1,7 | 2,5 |
| | F439220550RSWL | MONTATURA / MOUNTING | 31,5x31,5x132 | 9,5 | 12 |
| | | DIFFUSORE / DIFFUSER | 32x22,5x32 | 1,7 | 2,5 |
| | F439225150OOWL | MONTATURA / MOUNTING | 43,5x43,5x165 | 19 | 23 |
| DIFFUSORE / DIFFUSER | | 43x33,5x43 | 3,4 | 5,3 | |
| F439225550CRWL | MONTATURA / MOUNTING | 43,5x43,5x165 | 19 | 23 | |
| | DIFFUSORE / DIFFUSER | 43x33,5x43 | 3,4 | 5,3 | |
| F439225550NEWL | MONTATURA / MOUNTING | 43,5x43,5x165 | 19 | 23 | |
| | DIFFUSORE / DIFFUSER | 43x33,5x43 | 3,4 | 5,3 | |
| F439225550RSWL | MONTATURA / MOUNTING | 43,5x43,5x165 | 19 | 23 | |
| | DIFFUSORE / DIFFUSER | 43x33,5x43 | 3,4 | 5,3 | |
| FALENA | F301825150CRNE | CORPO / BODY | 70x10x30 | 0,2 | 1 |
| | | BASE / BASE | 14x80x35 | 3 | 4,5 |
| FLÛTE | F330025150TCNE | LAMPADA COMPLETA / COMPLETE LAMP | 31x202x31 | 6 | 10,1 |
| | F330030150TCNE | MONTATURA / MOUNTING | 43x217x41 | 11 | 14,5 |
| | | BASE / BASE | 47x7x47 | 10 | 12 |
| GALERIE | F440025500QZWL | MONTATURA / MOUNTING | 30x190x30 | 5 | 7 |
| | | DIFFUSORE / DIFFUSER | 30x15x15 | 0,5 | 0,6 |
| | | BASE / BASE | 28x32x25 | 14 | 18 |
| | F447630500QZWL | MONTATURA / MOUNTING | 30x190x30 | 5 | 9 |
| | | DIFFUSORE / DIFFUSER | 25x32x15 | 1,5 | 18 |
| | | BASE / BASE | 28x32x25 | 14 | 18 |
| LUMEN | F248225150BINE | MONTATURA / MOUNTING | 57x181x53,5 | 10,7 | 18 |
| | | DIFFUSORE / DIFFUSER | 54x52x54 | 4,8 | 7 |
| LUMINATOR | F005630200NSWL | LAMPADA COMPLETA / COMPLETE LAMP | 35,5x210x35,5 | 13 | 18,4 |
| | F005630210BIWL | LAMPADA COMPLETA / COMPLETE LAMP | 35,5x210x35,5 | 13 | 18,4 |
| | F005630210BLWL | LAMPADA COMPLETA / COMPLETE LAMP | 35,5x210x35,5 | 13 | 18,4 |

| Famiglia Family | Codice Code | Descrizione Description | Dimensione Size cm A x B x H | Kg netto Kg net | Kg lordo Kg gross |
|----------------------|----------------|--|---------------------------------|--------------------|----------------------|
| MERIDIANO | F441725550NFWL | MONTATURA / MOUNTING DIFFUSORE / DIFFUSER | 180x44x42 39x39x49 | 15 2,8 | 21,2 4,8 |
| | F441725550NRWL | MONTATURA / MOUNTING DIFFUSORE / DIFFUSER | 180x44x42 39x39x49 | 15 2,8 | 21,2 4,8 |
| | F441725550NTWL | MONTATURA / MOUNTING DIFFUSORE / DIFFUSER | 180x44x42 39x39x49 | 15 2,8 | 21,2 4,8 |
| NASKA | F810525200BINE | LAMPADA COMPLETA / COMPLETE LAMP | 165x70x70 | 63 | 65 |
| | F810525200NENE | LAMPADA COMPLETA / COMPLETE LAMP | 165x70x70 | 63 | 65 |
| OORT | OORT00001 | LAMPADA COMPLETA / COMPLETE LAMP | 120x25x10 | 3 | 4 |
| | OORT00010 | LAMPADA COMPLETA / COMPLETE LAMP | 120x25x10 | 3 | 4 |
| | OORT00002 | LAMPADA COMPLETA / COMPLETE LAMP | 160x25x10 | 3 | 4 |
| | OORT00011 | LAMPADA COMPLETA / COMPLETE LAMP | 160x25x10 | 3 | 4 |
| PAROLA | F265925100AMNE | MONTATURA / MOUNTING DIFFUSORE / DIFFUSER | 20x145x35 34,5x27x34,5 | 4,5 0,6 | 6 1,4 |
| | F265925100BINE | MONTATURA / MOUNTING DIFFUSORE / DIFFUSER | 20x145x35 34,5x27x34,5 | 4,5 0,6 | 6 1,4 |
| PAROLONA | F275130150BINE | BASE / BASE | 40x40x10 | 4 | 5 |
| | | DIFFUSORE / DIFFUSER | 41x41x36 | 3 | 2 |
| | | CORPO / BODY | 15x15x220 | 7 | 9 |
| PIRELLONE | F275930150KBNE | MONTATURA / MOUNTING DIFFUSORE / DIFFUSER | 48x192x48 52x20x192 | 12 6,7 | 15 11,3 |
| PRIMA SIGNORA | F289130150CBNE | MONTATURA / MOUNTING DIFFUSORE / DIFFUSER | 17x14,5x160 55x55x55 | 6 7,5 | 8 10 |
| RILUMINATOR | F425930350BIWL | LAMPADA COMPLETA / COMPLETE LAMP | 38x192,5x38 | 13 | 16,5 |
| SCINTILLA | F272930250CRNE | LAMPADA COMPLETA / COMPLETE LAMP | 35x196x30 | 7 | 9,2 |
| | F272930250NSNE | LAMPADA COMPLETA / COMPLETE LAMP | 35x196x30 | 7 | 9,2 |
| THEA | F444930550NFWL | MONTATURA / MOUNTING DIFFUSORE / DIFFUSER | 41x174,5x41 42,5x42,5x33,5 | 2,5 | 4,2 |
| | F444930575RTWL | MONTATURA / MOUNTING DIFFUSORE / DIFFUSER | 41x174,5x41 42,5x42,5x33,5 | 2,5 | 4,2 |
| TRIPOD | F439825150NENE | LAMPADA COMPLETA / COMPLETE LAMP | 78x22x174 | 7,5 | 17 |
| VERTIGO | F553130240CRWL | LAMPADA COMPLETA / COMPLETE LAMP | 40x220x40 | 11 | 13,5 |
| YUMI | F414330900NEWL | BASE / BASE | 60x10x60 | 18,5 | 20 |
| | | CORPO / BODY | 320x95x15 | 2,5 | 11 |
| | F414330200BIWL | BASE / BASE CORPO / BODY | 60x10x60 320x95x15 | 18,5 2,5 | 20 11 |

LAMPADE A PARETE E A PLAFONE WALL AND CEILING LAMPS



| Famiglia Family | Codice Code | Descrizione Description | Dimensione Size cm A x B x H | Kg netto Kg net | Kg lordo Kg gross |
|--------------------|----------------|--|--|----------------------|----------------------|
| ALICANTO | F443645160NEWL | MONTATURA / MOUNTING DIFFUSORE / DIFFUSER | 182x109x26 28x28x28 | 7 0,5 | 9,5 1,7 |
| | F443650160NEWL | MONTATURA / MOUNTING DIFFUSORE / DIFFUSER | 248x140x26 28x28x28 | 15 0,5 | 18 1,7 |
| APEX | F431145200BILE | LAMPADA COMPLETA / COMPLETE LAMP | 13,5x13,5x113 | 2,0 | 3,0 |
| | F431145200NELE | LAMPADA COMPLETA / COMPLETE LAMP | 13,5x13,5x113 | 2,0 | 3,0 |
| BIANCA | F432860150BILE | LAMPADA COMPLETA / COMPLETE LAMP | 21x16x21 | 1 | 1,1 |
| | F432865150BILE | LAMPADA COMPLETA / COMPLETE LAMP | 40x27,5x40 | 3 | 3,3 |
| | F432870150BINE | LAMPADA COMPLETA / COMPLETE LAMP | 61x57x61 | 6 | 8,5 |
| BONNET | F443245200BILE | LAMPADA COMPLETA / COMPLETE LAMP | 23x20x35 | 1 | 1,3 |
| | F443345200BILE | LAMPADA COMPLETA / COMPLETE LAMP | 23x20x35 | 1 | 1,3 |
| | F443245230ALLE | LAMPADA COMPLETA / COMPLETE LAMP | 20x20x35 | 1 | 1,3 |
| | F443345200ALLE | LAMPADA COMPLETA / COMPLETE LAMP | 23x20x35 | 1 | 1,3 |
| BRUCO | F353845100BINE | LAMPADA COMPLETA / COMPLETE LAMP | 14,5x17x29,5 | 1,5 | 2,5 |
| FALENA | F301945150CRNE | CORPO / BODY ATTACCO A PARETE / WALL ATTACHMENT | 70x10x30 19,5x7,5x16,5 | 0,2 0,4 | 1 0,6 |
| | FLEX | F431045200BILE | LAMPADA COMPLETA / COMPLETE LAMP | 22x16x41 | 1,7 |
| FONTANELLA | F447745550CRNE | DIFFUSORE / DIFFUSER MONTATURA / MOUNTING | 32,5x32,5x37,5 15x15x11 | 0,5 1,5 | 1 2 |
| | F447745550NENE | DIFFUSORE / DIFFUSER MONTATURA / MOUNTING | 32,5x32,5x37,5 15x15x11 | 0,5 1,5 | 1 2 |
| | F447745550OTNE | DIFFUSORE / DIFFUSER MONTATURA / MOUNTING | 32,5x32,5x37,5 15x15x11 | 0,5 1,5 | 1 2 |
| | F447750550CRNE | DIFFUSORE / DIFFUSER MONTATURA / MOUNTING | 32,5x32,5x37,5 15x15x11 | 0,5 1,5 | 1 2 |
| | F447750550NENE | DIFFUSORE / DIFFUSER MONTATURA / MOUNTING | 32,5x32,5x37,5 15x15x11 | 0,5 1,5 | 1 2 |
| | F447750550OTNE | DIFFUSORE / DIFFUSER MONTATURA / MOUNTING | 32,5x32,5x37,5 15x15x11 | 0,5 1,5 | 1 2 |
| | GALERIE | F439945500QZLE | MONTATURA / MOUNTING DIFFUSORE / DIFFUSER | 19x23x19 30x15x15 | 2,5 0,5 |
| IO | | F429945200BILE | LAMPADA COMPLETA / COMPLETE LAMP | 14x13,5x20,5 | 0,4 |
| | F429945200BLLE | LAMPADA COMPLETA / COMPLETE LAMP | 14x13,5x20,5 | 0,4 | 0,5 |
| | F429945200GSLE | LAMPADA COMPLETA / COMPLETE LAMP | 14x13,5x20,5 | 0,4 | 0,5 |
| | F429945200ROLE | LAMPADA COMPLETA / COMPLETE LAMP | 14x13,5x20,5 | 0,4 | 0,5 |
| LUNAIRE | F424665360ONLE | MONTATURA / MOUNTING TAPPO / PLUG | 86x20x86 45x30x45 | 6,8 1,5 | 10,5 2,3 |
| | F424665360RNLE | MONTATURA / MOUNTING TAPPO / PLUG | 86x20x86 45x30x45 | 5,3 1,5 | 9 2,3 |
| | F424665370OOLE | MONTATURA / MOUNTING TAPPO / PLUG | 86x20x86 45x30x45 | 6,8 1,5 | 10,5 2,3 |
| | F424665370RMLE | MONTATURA / MOUNTING TAPPO / PLUG | 86x20x86 45x30x45 | 5,3 1,5 | 9 2,3 |
| | F424665350BILE | LAMPADA COMPLETA / COMPLETE LAMP | 86x20x86 | 6,8 | 10,5 |
| | F424665350NELE | LAMPADA COMPLETA / COMPLETE LAMP | 86x20x86 | 6,8 | 10,5 |

| Famiglia Family | Codice Code | Descrizione Description | Dimensione Size cm A x B x H | Kg netto Kg net | Kg lordo Kg gross |
|--------------------|----------------|--|---------------------------------|--------------------|----------------------|
| | F424660350BILE | LAMPADA COMPLETA / COMPLETE LAMP | 56x57x16,5 | 2 | 4,5 |
| NASKA | F810340200BINE | CORPO / BODY ATTACCO A PARETE / WALL ATTACHMENT | 23x38x20 13x9x15 | 1,9 0,2 | 2,5 0,3 |
| | F810340200NENE | CORPO / BODY ATTACCO A PARETE / WALL ATTACHMENT | 23x38x20 13x9x15 | 1,9 0,2 | 2,5 0,3 |
| | F810340240CRNE | CORPO / BODY ATTACCO A PARETE / WALL ATTACHMENT | 23x38x20 13x9x15 | 1,9 0,2 | 2,5 0,3 |
| | F810350200BINE | CORPO / BODY ATTACCO A PARETE / WALL ATTACHMENT | 18x67x28 13x9x15 | 2,8 0,2 | 3,5 0,3 |
| | F810350200NENE | CORPO / BODY ATTACCO A PARETE / WALL ATTACHMENT | 18x67x28 13x9x15 | 2,8 0,2 | 3,5 0,3 |
| | F810350240CRNE | CORPO / BODY ATTACCO A PARETE / WALL ATTACHMENT | 18x67x28 13x9x15 | 2,8 0,2 | 3,5 0,3 |
| | F810350200BIWL | CORPO / BODY ATTACCO A PARETE / WALL ATTACHMENT | 18x67x28 13x9x15 | 2,8 0,2 | 3,5 0,3 |
| | F810350200NEWL | CORPO / BODY ATTACCO A PARETE / WALL ATTACHMENT | 18x67x28 13x9x15 | 2,8 0,2 | 3,5 0,3 |
| | F810350240CRWL | CORPO / BODY ATTACCO A PARETE / WALL ATTACHMENT | 18x67x28 13x9x15 | 2,8 0,2 | 3,5 0,3 |
| | F810350240OOWL | CORPO / BODY ATTACCO A PARETE / WALL ATTACHMENT | 18x67x28 13x9x15 | 2,8 0,2 | 3,5 0,3 |
| NOBI | F302345150BINE | LAMPADA COMPLETA / COMPLETE LAMP | 44,5x17x13,5 | 0,5 | 0,9 |
| | F302345150CRLE | LAMPADA COMPLETA / COMPLETE LAMP | 44,5x17x13,5 | 0,5 | 0,9 |
| | F302345150NSLE | LAMPADA COMPLETA / COMPLETE LAMP | 44,5x17x13,5 | 0,5 | 0,9 |
| OORT | OORT00030 | LAMPADA COMPLETA / COMPLETE LAMP | 41x18x22 | 1,2 | 1,8 |
| | OORT00031 | LAMPADA COMPLETA / COMPLETE LAMP | 41x18x22 | 1,2 | 1,8 |
| | OORT00040 | LAMPADA COMPLETA / COMPLETE LAMP | 41x41x46 | 5 | 7 |
| | OORT00041 | LAMPADA COMPLETA / COMPLETE LAMP | 41x41x46 | 5 | 7 |
| PALLINA | F443060150NENE | LAMPADA COMPLETA / COMPLETE LAMP | 19x19x19 | 1 | 1,5 |
| | F443060150NSNE | LAMPADA COMPLETA / COMPLETE LAMP | 19x19x19 | 1 | 1,5 |
| | F443060150ORNE | LAMPADA COMPLETA / COMPLETE LAMP | 19x19x19 | 1 | 1,5 |
| | F443060150OTNE | LAMPADA COMPLETA / COMPLETE LAMP | 19x19x19 | 1 | 1,5 |
| PANGEN | F419766350BINE | LAMPADA COMPLETA / COMPLETE LAMP | 67x30x67 | 3,5 | 4,5 |
| | F419766350NENE | LAMPADA COMPLETA / COMPLETE LAMP | 67x30x67 | 3,5 | 4,5 |
| | F419766350ORNE | LAMPADA COMPLETA / COMPLETE LAMP | 67x30x67 | 3,5 | 4,5 |
| PAROLA | F268945150AMNE | MONTATURA / MOUNTING DIFFUSORE / DIFFUSER | 27x11x24 34,5x27x34,5 | 0,4 0,6 | 0,7 1,4 |
| | F268945150BINE | MONTATURA / MOUNTING DIFFUSORE / DIFFUSER | 27x11x24 34,5x27x34,5 | 0,4 0,6 | 0,7 1,4 |
| RIGA | F521440250BILE | LAMPADA COMPLETA / COMPLETE LAMP | 14,5x14,5x43 | 1,1 | 1,3 |
| | F521440260AXLE | LAMPADA COMPLETA / COMPLETE LAMP | 14,5x14,5x43 | 1,1 | 1,3 |
| | F521440260NSLE | LAMPADA COMPLETA / COMPLETE LAMP | 14,5x14,5x43 | 1,1 | 1,3 |
| | F521450250BILE | LAMPADA COMPLETA / COMPLETE LAMP | 16x14x80 | 2,2 | 2,5 |
| | F521450260AXLE | LAMPADA COMPLETA / COMPLETE LAMP | 16x14x80 | 2,2 | 2,5 |
| | F521450260NSLE | LAMPADA COMPLETA / COMPLETE LAMP | 16x14x80 | 2,2 | 2,5 |
| | F539845250BILE | LAMPADA COMPLETA / COMPLETE LAMP | 13x13x60 | 1,8 | 2,5 |
| | F539845260AXLE | LAMPADA COMPLETA / COMPLETE LAMP | 13x13x60 | 1,8 | 2,5 |
| | F539845260NSLE | LAMPADA COMPLETA / COMPLETE LAMP | 13x13x60 | 1,8 | 2,5 |
| | F521440250BINE | LAMPADA COMPLETA / COMPLETE LAMP | 14,5x14x43 | 1,1 | 1,3 |

| Famiglia Family | Codice Code | Descrizione Description | Dimensione Size cm A x B x H | Kg netto Kg net | Kg lordo Kg gross |
|--------------------|-----------------|--|---------------------------------|--------------------|----------------------|
| SCINTILLA | FP15045250CRNE | LAMPADA COMPLETA / COMPLETE LAMP | 28x26x20 | 0,4 | 0,9 |
| | FP15045250NSNE | LAMPADA COMPLETA / COMPLETE LAMP | 20x28x26 | 0,4 | 1,8 |
| | FP30050250CRNE | LAMPADA COMPLETA / COMPLETE LAMP | 28x26x20 | 0,4 | 0,9 |
| | FP30050250NSNE | LAMPADA COMPLETA / COMPLETE LAMP | 28x26x20 | 0,4 | 0,9 |
| SILLABA | F277560150BINE | LAMPADA COMPLETA / COMPLETE LAMP | 19x12x18 | 0,2 | 0,5 |
| | F277565150BINE | LAMPADA COMPLETA / COMPLETE LAMP | 19x12x17,5 | 0,4 | 0,6 |
| | F277570150BILE | LAMPADA COMPLETA / COMPLETE LAMP | 20,8x13x22,6 | 0,7 | 1 |
| | F277570150BINE | LAMPADA COMPLETA / COMPLETE LAMP | 21x13x23 | 0,6 | 0,9 |
| SILLABONE | F279370150BINE | LAMPADA COMPLETA / COMPLETE LAMP | 40x30x41 | 3,5 | 4,1 |
| SOLE | F413940150BILE | LAMPADA COMPLETA / COMPLETE LAMP | 15x18x60 | 3,0 | 3,0 |
| | F414040150BILE | LAMPADA COMPLETA / COMPLETE LAMP | 13x6x16 | 1,0 | 1,5 |
| THEA | F444965550NFLE | MONTATURA / MOUNTING DIFFUSORE / DIFFUSER | 16,7x16,7x20 28,7x28,7x24 | 1 1,2 | 1,4 1,9 |
| | F444965575RTLLE | MONTATURA / MOUNTING DIFFUSORE / DIFFUSER | 16,7x16,7x20 28,7x28,7x24 | 1 1,2 | 1,4 1,9 |
| | F444970550NFLE | MONTATURA / MOUNTING DIFFUSORE / DIFFUSER | 22,3x22,3x27 42,5x42,5x33,5 | 2,6 2,6 | 3,3 4,3 |
| | F444970575RTLLE | MONTATURA / MOUNTING DIFFUSORE / DIFFUSER | 22,3x22,3x27 42,5x42,5x33,5 | 2,6 2,6 | 3,3 4,3 |
| TROPICO | F442160550NELE | MONTATURA / MOUNTING DIFFUSORE / DIFFUSER | 32x32x16 32x32x16 | 1 1 | 1,7 1,7 |
| | F442160550OOLE | MONTATURA / MOUNTING DIFFUSORE / DIFFUSER | 32x32x16 32x32x16 | 1 1 | 1,7 1,7 |
| | F442165550NELE | MONTATURA / MOUNTING DIFFUSORE / DIFFUSER | 44x44x21 44x44x21 | 2 2 | 3,4 3,4 |
| | F442165550OOLE | MONTATURA / MOUNTING DIFFUSORE / DIFFUSER | 44x44x21 44x44x21 | 2 2 | 3,4 3,4 |
| | F442170550NELE | MONTATURA / MOUNTING DIFFUSORE / DIFFUSER | 56x56x21 56x56x21 | 3,7 3,7 | 5,8 5,8 |
| | F442170550OOLE | MONTATURA / MOUNTING DIFFUSORE / DIFFUSER | 56x56x21 56x56x21 | 3,7 3,7 | 5,8 5,8 |

LAMPADE A SOSPENSIONE

SUSPENSION LAMPS



| Famiglia Family | Codice Code | Descrizione Description | Dimensione Size cm A x B x H | Kg netto Kg net | Kg lordo Kg gross |
|--------------------|----------------------|----------------------------------|---------------------------------|--------------------|----------------------|
| 0024 | F002485150TRNE | MONTATURA / MOUNTING | 36x36x70,5 | 5 | 6 |
| | | DIFFUSORE / DIFFUSER | 62x20x62 | 17 | 20 |
| AMAX | F544480350BINE | LAMPADA COMPLETA / COMPLETE LAMP | 35x50x35 | 2,2 | 3,4 |
| | F544485350BINE | LAMPADA COMPLETA / COMPLETE LAMP | 55x50x55 | 3,7 | 5,9 |
| | F544490350BINE | LAMPADA COMPLETA / COMPLETE LAMP | 85,5x76x85,5 | 12 | 22 |
| | F544495350BINE | LAMPADA COMPLETA / COMPLETE LAMP | 110x98x110 | 17,5 | 33,5 |
| AVICO | F556180350BINE | LAMPADA COMPLETA / COMPLETE LAMP | 125,5x66,5x125,5 | 20 | 30 |
| | F556180375NENE | LAMPADA COMPLETA / COMPLETE LAMP | 125,5x66,5x125,5 | 20 | 30 |
| | F556185350BINE | LAMPADA COMPLETA / COMPLETE LAMP | 165x96x165 | 30 | 45 |
| | F556185375NENE | LAMPADA COMPLETA / COMPLETE LAMP | 165x96x165 | 30 | 45 |
| BIANCA | F430685150BILE | MONTATURA / MOUNTING | 20x15x20 | 1 | 1,2 |
| | | DIFFUSORE / DIFFUSER | 40x27,5x40 | 1,8 | 2,1 |
| | F430680150BILE | LAMPADA COMPLETA / COMPLETE LAMP | 21x16x21 | 1 | 1,2 |
| BOLLA | F430690150BINE | LAMPADA COMPLETA / COMPLETE LAMP | 61x57x61 | 6 | 8,5 |
| | F354085100TRNE | MONTATURA / MOUNTING | 22x15x20 | 0,7 | 1,5 |
| | | DIFFUSORE / DIFFUSER | 40x40x40 | 3 | 4 |
| F354090100TRNE | MONTATURA / MOUNTING | 22x15x20 | 0,7 | 1,5 | |
| | DIFFUSORE / DIFFUSER | 65x40x40 | 3,5 | 4,5 | |
| CHANDELIER | F549180250NBNE | LAMPADA COMPLETA / COMPLETE LAMP | 90x20x90 | 13 | 14,5 |
| | F549180260OBNE | LAMPADA COMPLETA / COMPLETE LAMP | 90x20x90 | 13 | 14,5 |
| | F549185250NBNE | LAMPADA COMPLETA / COMPLETE LAMP | 170x20x170 | 18 | 25 |
| | F549185260OBNE | LAMPADA COMPLETA / COMPLETE LAMP | 170x20x170 | 18 | 25 |
| | F549190250NBNE | LAMPADA COMPLETA / COMPLETE LAMP | 100x20x100 | 19 | 21 |
| | F549190260OBNE | LAMPADA COMPLETA / COMPLETE LAMP | 100x20x100 | 19 | 21 |
| | F549195250NBNE | LAMPADA COMPLETA / COMPLETE LAMP | 157x20x157 | 31 | 35 |
| | F549195260OBNE | LAMPADA COMPLETA / COMPLETE LAMP | 157x20x157 | 31 | 35 |
| CHESHIRE | F425785350BINE | LAMPADA COMPLETA / COMPLETE LAMP | 44x51,5x44,5 | 2,35 | 4,1 |
| | F425785350NENE | LAMPADA COMPLETA / COMPLETE LAMP | 44x51,5x44 | 2,35 | 4,1 |
| EQUATORE | F439080150OOLE | MONTATURA / MOUNTING | 32x56x32 | 5,4 | 6,4 |
| | | DIFFUSORE / DIFFUSER | 32x22,5x32 | 1,7 | 2,5 |
| | F439080550CRLE | MONTATURA / MOUNTING | 32x56x32 | 5,4 | 6,4 |
| | | DIFFUSORE / DIFFUSER | 32x22,5x32 | 1,7 | 2,5 |
| | F439080550NELE | MONTATURA / MOUNTING | 32x56x32 | 5,4 | 6,4 |
| | | DIFFUSORE / DIFFUSER | 32x22,5x32 | 1,7 | 2,5 |
| | F439080550RSLE | MONTATURA / MOUNTING | 32x56x32 | 5,4 | 6,4 |
| | | DIFFUSORE / DIFFUSER | 32x22,5x32 | 1,7 | 2,5 |
| | F439085150OOLE | MONTATURA / MOUNTING | 43x76x43 | 7,4 | 10 |
| | | DIFFUSORE / DIFFUSER | 43x33,5x43 | 3,4 | 5,3 |
| F439085550CRLE | MONTATURA / MOUNTING | 43x76x43 | 7,4 | 10 | |
| | DIFFUSORE / DIFFUSER | 43x33,5x43 | 3,4 | 5,3 | |
| F439085550NELE | MONTATURA / MOUNTING | 43x76x43 | 7,4 | 10 | |
| | DIFFUSORE / DIFFUSER | 43x33,5x43 | 3,4 | 5,3 | |
| F439085550RSLE | MONTATURA / MOUNTING | 43x76x43 | 7,4 | 10 | |
| | DIFFUSORE / DIFFUSER | 43x33,5x43 | 3,4 | 5,3 | |
| F439090150OOLE | MONTATURA / MOUNTING | 61x90x61 | 12,5 | 18,8 | |
| | DIFFUSORE / DIFFUSER | 32x22,5x32 | 1,7 | 2,5 | |

| Famiglia Family | Codice Code | Descrizione Description | Dimensione Size cm A x B x H | Kg netto Kg net | Kg lordo Kg gross |
|----------------------|----------------|--|---------------------------------|--------------------|----------------------|
| | F439090550CRLE | MONTATURA / MOUNTING DIFFUSORE / DIFFUSER | 61x90x61 61x47x61 | 12,5 4,5 | 18,8 7,6 |
| | F439090550NELE | MONTATURA / MOUNTING DIFFUSORE / DIFFUSER | 61x90x61 61x47x61 | 12,5 4,5 | 18,8 7,6 |
| | F439090550RSLE | MONTATURA / MOUNTING DIFFUSORE / DIFFUSER | 61x90x61 61x47x61 | 12,5 4,5 | 18,8 7,6 |
| FONTANELLA | F447890550CRNE | MONTATURA / MOUNTING DIFFUSORE / DIFFUSER | 23x23x54,5 48,5x48,5x27,5 | 2 0,5 | 3 1 |
| | F447890550NENE | MONTATURA / MOUNTING DIFFUSORE / DIFFUSER | 23x23x54,5 48,5x48,5x27,5 | 2 0,5 | 3 1 |
| | F447890550OTNE | MONTATURA / MOUNTING DIFFUSORE / DIFFUSER | 23x23x54,5 48,5x48,5x27,5 | 2 0,5 | 3 1 |
| | F447885550CRNE | MONTATURA / MOUNTING DIFFUSORE / DIFFUSER | 23x23x54,5 32,5x32,5x27,5 | 3 0,5 | 4 1 |
| | F447885550NENE | MONTATURA / MOUNTING DIFFUSORE / DIFFUSER | 23x23x54,5 32,5x32,5x27,5 | 3 0,5 | 4 1 |
| | F447885550OTNE | MONTATURA / MOUNTING DIFFUSORE / DIFFUSER | 23x23x54,5 32,5x32,5x27,5 | 3 0,5 | 4 1 |
| FLÛTE | F333780150TCNE | LAMPADA COMPLETA / COMPLETE LAMP | 45x28x27 | 1 | 1,7 |
| | F333780550NENE | LAMPADA COMPLETA / COMPLETE LAMP | 45x28x27 | 1 | 1,7 |
| | F333780550RMNE | LAMPADA COMPLETA / COMPLETE LAMP | 45x28x27 | 1 | 1,7 |
| | F333785550TCNE | LAMPADA COMPLETA / COMPLETE LAMP | 85x28x27 | 2,2 | 3,6 |
| | F333790550TCNE | LAMPADA COMPLETA / COMPLETE LAMP | 135x26x25 | 3,5 | 5 |
| GLOBO DI LUCE | F364480150CRNE | LAMPADA COMPLETA / COMPLETE LAMP | 26,5x23,5x26,5 | 1,3 | 1,9 |
| | F364480150RMNE | LAMPADA COMPLETA / COMPLETE LAMP | 26,5x23,5x26,5 | 1,3 | 1,9 |
| | F364485150CRNE | LAMPADA COMPLETA / COMPLETE LAMP | 40x40x40 | 2 | 3,1 |
| | F364485150RMNE | LAMPADA COMPLETA / COMPLETE LAMP | 40x40x40 | 2 | 3,1 |
| | F364490150CRNE | LAMPADA COMPLETA / COMPLETE LAMP | 60x60x60 | 5 | 7 |
| | F364490150RMNE | LAMPADA COMPLETA / COMPLETE LAMP | 60x60x60 | 5 | 7 |
| HUNA | F505985200ALNE | LAMPADA COMPLETA / COMPLETE LAMP | 53x38x53 | 1,7 | 2,5 |
| | F505985200NENE | LAMPADA COMPLETA / COMPLETE LAMP | 53x38x53 | 1,7 | 2,5 |
| LAMPARA | F500090200ALNE | LAMPADA COMPLETA / COMPLETE LAMP | 47x60x47 | 2 | 2,8 |
| | F500090220BINE | LAMPADA COMPLETA / COMPLETE LAMP | 47x60x47 | 2 | 2,8 |
| MERIDIANO | F441785550NFLE | MONTATURA / MOUNTING DIFFUSORE / DIFFUSER | 23x23x54,5 39x39x49 | 3 2,8 | 4 4,8 |
| | F441785550NRLE | MONTATURA / MOUNTING DIFFUSORE / DIFFUSER | 23x23x54,5 39x39x49 | 3 2,8 | 4 4,8 |
| | F441785550NTLE | MONTATURA / MOUNTING DIFFUSORE / DIFFUSER | 23x23x54,5 39x39x49 | 3 2,8 | 4 4,8 |
| | F441790550NFLE | MONTATURA / MOUNTING DIFFUSORE / DIFFUSER | 23x23x68 48,5x48,5x63 | 4,1 6 | 5,4 9 |
| | F441790550NRLE | MONTATURA / MOUNTING DIFFUSORE / DIFFUSER | 23x23x68 48,5x48,5x63 | 4,1 6 | 5,4 9 |
| | F441790550NTLE | MONTATURA / MOUNTING DIFFUSORE / DIFFUSER | 23x23x68 48,5x48,5x63 | 4,1 6 | 5,4 9 |
| OORT | OORT00003 | MONTATURA / MOUNTING DIFFUSORE / DIFFUSER | 23x21x10,5 149,5x16,5x10 | 0,7 1,7 | 0,9 2,7 |
| | OORT00012 | MONTATURA / MOUNTING DIFFUSORE / DIFFUSER | 23x21x10,5 149,5x16,5x10 | 0,7 1,7 | 0,9 2,7 |
| | OORT00004 | MONTATURA / MOUNTING DIFFUSORE / DIFFUSER | 28x30x11,5 179,5x16,5x10 | 1,6 2 | 2 3,5 |

| Famiglia Family | Codice Code | Descrizione Description | Dimensione Size cm A x B x H | Kg netto Kg net | Kg lordo Kg gross |
|--------------------|----------------|--|--|----------------------|------------------------|
| | OORT00013 | MONTATURA / MOUNTING DIFFUSORE / DIFFUSER | 28x30x11,5 179,5x16,5x10 | 1,6 2 | 2 3,5 |
| | OORT00005 | MONTATURA / MOUNTING DIFFUSORE / DIFFUSER | 28x30x11,5 70,5x16,5x10 | 1,6 1 | 2 1,4 |
| | OORT00014 | MONTATURA / MOUNTING DIFFUSORE / DIFFUSER | 28x30x11,5 70,5x16,5x10 | 1,6 1 | 2 1,4 |
| | OORT00006 | MONTATURA / MOUNTING DIFFUSORE / DIFFUSER | 28x30x11,5 149,5x16,5x10 | 1,6 1,5 | 2 2,5 |
| | OORT00015 | MONTATURA / MOUNTING DIFFUSORE / DIFFUSER | 28x30x11,5 149,5x16,5x10 | 1,6 1,5 | 2 2,5 |
| | OORT00007 | MONTATURA / MOUNTING DIFFUSORE / DIFFUSER | 28x30x11,5 179,5x16,5x10 | 1,6 2 | 2 3,5 |
| | OORT00016 | MONTATURA / MOUNTING DIFFUSORE / DIFFUSER | 28x30x11,5 179,5x16,5x10 | 1,6 2 | 2 3,5 |
| | OORT00008 | MONTATURA / MOUNTING DIFFUSORE / DIFFUSER | 28x30x11,5 70,5x16,5x10 | 1,6 1 | 2 1,4 |
| | OORT00017 | MONTATURA / MOUNTING DIFFUSORE / DIFFUSER | 28x30x11,5 70,5x16,5x10 | 1,6 1 | 2 1,4 |
| | OORT00009 | MONTATURA / MOUNTING DIFFUSORE / DIFFUSER DIFFUSORE / DIFFUSER DIFFUSORE / DIFFUSER | 28x30x11,5 70,5x16,5x10 149,5x16,5x10 179,5x16,5x10 | 1,6 1 1,5 2 | 2 1,4 2,5 3,5 |
| | OORT00018 | MONTATURA / MOUNTING DIFFUSORE / DIFFUSER DIFFUSORE / DIFFUSER DIFFUSORE / DIFFUSER | 28x30x11,5 70,5x16,5x10 149,5x16,5x10 179,5x16,5x10 | 1,6 1 1,5 2 | 2 1,4 2,5 3,5 |
| PALLINA | F443080150ORNE | LAMPADA COMPLETA / COMPLETE LAMP | 19x19x42 | 1,5 | 2 |
| | F443080150NENE | LAMPADA COMPLETA / COMPLETE LAMP | 19x19x42 | 1,5 | 2 |
| | F443080150NSNE | LAMPADA COMPLETA / COMPLETE LAMP | 19x19x42 | 1,5 | 2 |
| | F443080150OTNE | LAMPADA COMPLETA / COMPLETE LAMP | 19x19x42 | 1,5 | 2 |
| PANGEN | F419685350BINE | LAMPADA COMPLETA / COMPLETE LAMP | 67x30x67 | 3,5 | 4,5 |
| | F419685350NENE | LAMPADA COMPLETA / COMPLETE LAMP | 67x30x67 | 3,5 | 4,5 |
| | F419685350RONE | LAMPADA COMPLETA / COMPLETE LAMP | 67x30x67 | 3,5 | 4,5 |
| PAROLA | F428485100AMNE | MONTATURA / MOUNTING DIFFUSORE / DIFFUSER | 13,5x12,5x13,5 41x36x41 | 0,3 2 | 0,4 3 |
| | F428485100BINE | MONTATURA / MOUNTING DIFFUSORE / DIFFUSER | 13,5x12,5x13,5 41x36x41 | 0,3 2 | 0,4 3 |
| PINECONE | F433990550CBNE | LAMPADA COMPLETA / COMPLETE LAMP | 64x58x64 | 11 | 14 |
| | F433990550TCNE | LAMPADA COMPLETA / COMPLETE LAMP | 64x58x64 | 11 | 14 |
| | F433990575OBNE | LAMPADA COMPLETA / COMPLETE LAMP | 65x58x65 | 11 | 14 |
| | F433990575TONE | LAMPADA COMPLETA / COMPLETE LAMP | 64x58x64 | 11 | 14 |
| | F436385550CBNE | LAMPADA COMPLETA / COMPLETE LAMP | 40x40x40 | 5,5 | 6,5 |
| | F436385550TCNE | LAMPADA COMPLETA / COMPLETE LAMP | 40x40x40 | 5,5 | 6,5 |
| | F436385575OBNE | LAMPADA COMPLETA / COMPLETE LAMP | 40x40x40 | 5,5 | 6,5 |
| | F436385575TONE | LAMPADA COMPLETA / COMPLETE LAMP | 40x40x40 | 5,5 | 6,5 |
| | F446690550TCLE | LAMPADA COMPLETA / COMPLETE LAMP | 38,5x37x90 | 6,3 | 8,5 |
| | F446690575TOLE | LAMPADA COMPLETA / COMPLETE LAMP | 38,5x37x90 | 6,3 | 8,5 |
| SCINTILLA | FS15085250CRNE | LAMPADA COMPLETA / COMPLETE LAMP | 36x15x26 | 0,5 | 1 |
| | FS15085250NSNE | LAMPADA COMPLETA / COMPLETE LAMP | 36x15x26 | 0,5 | 1 |
| | FS30090250CRNE | LAMPADA COMPLETA / COMPLETE LAMP | 36x15x26 | 0,6 | 1 |
| | FS30090250NSNE | LAMPADA COMPLETA / COMPLETE LAMP | 14x36x26 | 0,5 | 0,9 |

| Famiglia Family | Codice Code | Descrizione Description | Dimensione Size cm A x B x H | Kg netto Kg net | Kg lordo Kg gross |
|--------------------|----------------|--|---------------------------------|--------------------|----------------------|
| SERPENTINE | F417585350BLE | LAMPADA COMPLETA / COMPLETE LAMP | 14x14x130 | 2,5 | 3,0 |
| SETAREH | F438G80550NBLE | MONTATURA / MOUNTING DIFFUSORE / DIFFUSER | 25x80,5x25 50,5x8,5x50,5 | 2 0,9 | 3,5 2 |
| | F438G80550OBLE | MONTATURA / MOUNTING DIFFUSORE / DIFFUSER | 25x80,5x25 25x80,5x25 | 2 2 | 3,5 3,5 |
| | F438G85550NBLE | MONTATURA / MOUNTING DIFFUSORE / DIFFUSER | 25x80,5x25 70,5x8,5x70,5 | 2 2,2 | 3,5 4,5 |
| | F438G85550OBLE | MONTATURA / MOUNTING DIFFUSORE / DIFFUSER | 25x80,5x25 70,5x8,5x70,5 | 2 2,2 | 3,5 4,5 |
| | F438G90550NBLE | MONTATURA / MOUNTING DIFFUSORE / DIFFUSER | 30x94x30,5 90,5x8,5x90,5 | 3 5,5 | 4,5 7,5 |
| | F438G90550OBLE | MONTATURA / MOUNTING DIFFUSORE / DIFFUSER | 30x94x30,5 90,5x8,5x90,5 | 3 5,5 | 4,5 7,5 |
| | F438M85550NBLE | MONTATURA / MOUNTING DIFFUSORE / DIFFUSER | 25x80,5x25 70x1x70 | 2 1,6 | 3,5 2,5 |
| | F438M85550OBLE | MONTATURA / MOUNTING DIFFUSORE / DIFFUSER | 25x80,5x25 70x1x70 | 2 1,6 | 3,5 2,5 |
| | F438M90550NBLE | MONTATURA / MOUNTING DIFFUSORE / DIFFUSER | 30,5x94x30,5 90x1x90 | 3 3 | 4,5 5 |
| | F438M90550OBLE | MONTATURA / MOUNTING DIFFUSORE / DIFFUSER | 30,5x94x30,5 90x1x90 | 3 3 | 4,5 5 |
| | F440485550NBLE | MONTATURA / MOUNTING DIFFUSORE / DIFFUSER | 25x100,5x25 19x18,5x20 | 1,7 0,4 | 1,7 0,7 |
| | F440485550OBLE | MONTATURA / MOUNTING DIFFUSORE / DIFFUSER | 25x100,5x25 19x18,5x20 | 1,7 0,4 | 1,7 0,7 |
| | F440590550NBLE | MONTATURA / MOUNTING DIFFUSORE / DIFFUSER | 25x113,5x25 19x18,5x20 | 2 0,4 | 2 0,7 |
| | F440590550OBLE | MONTATURA / MOUNTING DIFFUSORE / DIFFUSER | 25x113,5x25 19x18,5x20 | 2 0,4 | 2 0,7 |
| | F438080550NBLE | LAMPADA COMPLETA / COMPLETE LAMP | 25x80,5x25 | 2 | 3,5 |
| | F438080550OBLE | LAMPADA COMPLETA / COMPLETE LAMP | 25x80,5x25 | 2 | 3,5 |
| | F438380550NBLE | LAMPADA COMPLETA / COMPLETE LAMP | 50,5x48x50,5 | 3 | 4,5 |
| | F438380550OBLE | LAMPADA COMPLETA / COMPLETE LAMP | 50,5x48x50,5 | 3 | 4,5 |
| THEA | F444985550NFLE | MONTATURA / MOUNTING DIFFUSORE / DIFFUSER | 20x20x46 28,7x28,7x24 | 1,9 1,2 | 2,5 1,9 |
| | F444985575RTLE | MONTATURA / MOUNTING DIFFUSORE / DIFFUSER | 20x20x46 28,7x28,7x24 | 1,9 1,2 | 2,5 1,9 |
| | F444990550NFLE | MONTATURA / MOUNTING DIFFUSORE / DIFFUSER | 20x20x68 42,5x42,5x33,5 | 3 2,6 | 4 4,3 |
| | F444990575RTLE | MONTATURA / MOUNTING DIFFUSORE / DIFFUSER | 20x20x68 42,5x42,5x33,5 | 3 2,6 | 4 4,3 |
| TUTTI | F446880240..LE | LAMPADA COMPLETA / COMPLETE LAMP | 25x80,5x25 | 2 | 3,5 |
| | F446980240..LE | MONTATURA / MOUNTING CORPO / BODY | 28x30x11,5 23,5x18,5x29,5 | 1 0,5 | 1,4 0,8 |
| | F447080240..LE | MONTATURA / MOUNTING CORPO / BODY | 28x30x11,5 23,5x18,5x29,5 | 1 0,5 | 1,4 0,8 |
| | F447180240..LE | MONTATURA / MOUNTING CORPO / BODY | 28x30x11,5 23,5x18,5x29,5 | 1 0,5 | 1,4 0,8 |
| | F447380240..LE | MONTATURA / MOUNTING CORPO / BODY | 28x30x11,5 23,5x18,5x29,5 | 1 0,5 | 1,4 0,8 |
| | F447280240..LE | MONTATURA / MOUNTING CORPO / BODY | 28x30x11,5 23,5x18,5x29,5 | 1 0,5 | 1,4 0,8 |
| | F447480240..LE | MONTATURA / MOUNTING CORPO / BODY | 28x30x11,5 23,5x18,5x29,5 | 1 0,5 | 1,4 0,8 |

| Famiglia Family | Codice Code | Descrizione Description | Dimensione Size cm A x B x H | Kg netto Kg net | Kg lordo Kg gross |
|--------------------|----------------|--|--|--|--|
| | F447580240..LE | MONTATURA / MOUNTING CORPO / BODY | 28x30x11,5 23,5x18,5x29,5 | 1 0,5 | 1,4 0,8 |
| | F446890240LE | MONTATURA / MOUNTING CORPO / BODY CORPO / BODY CORPO / BODY CORPO / BODY CORPO / BODY CORPO / BODY CORPO / BODY CORPO / BODY CORPO / BODY | 63x62x10 23,5x18,5x29,5 23,5x18,5x29,5 23,5x18,5x29,5 23,5x18,5x29,5 23,5x18,5x29,5 23,5x18,5x29,5 23,5x18,5x29,5 23,5x18,5x29,5 23,5x18,5x29,5 | 4,3 0,5 0,5 0,5 0,5 0,5 0,5 0,5 0,5 0,5 | 6,4 0,8 0,8 0,8 0,8 0,8 0,8 0,8 0,8 0,8 |

OUTDOOR



| Famiglia Family | Codice Code | Descrizione Description | Dimensione Size cm A x B x H | Kg netto Kg net | Kg lordo Kg gross |
|-------------------------|----------------|--|---------------------------------|--------------------|----------------------|
| NASKA | F810528200BINE | LAMPADA COMPLETA / COMPLETE LAMP | 165x70x70 | 63 | 65 |
| | F810528200NENE | LAMPADA COMPLETA / COMPLETE LAMP | 165x70x70 | 63 | 65 |
| OORT | OORT05001 | LAMPADA COMPLETA / COMPLETE LAMP | 21x21x38 | 0,7 | 1,2 |
| | OORT05011 | LAMPADA COMPLETA / COMPLETE LAMP | 21x21x38 | 0,7 | 1,2 |
| | OORT05003 | LAMPADA COMPLETA / COMPLETE LAMP | 21x21x48 | 0,8 | 1,4 |
| | OORT05013 | LAMPADA COMPLETA / COMPLETE LAMP | 21x21x48 | 0,8 | 1,4 |
| | OORT05005 | LAMPADA COMPLETA / COMPLETE LAMP | 21x21x58 | 0,9 | 1,6 |
| | OORT05015 | LAMPADA COMPLETA / COMPLETE LAMP | 21x21x58 | 0,9 | 1,6 |
| | OORT05031 | LAMPADA COMPLETA / COMPLETE LAMP | 45x41x41 | 2,6 | 3,7 |
| | OORT05041 | LAMPADA COMPLETA / COMPLETE LAMP | 45x41x41 | 2,6 | 3,7 |
| | OORT05033 | LAMPADA COMPLETA / COMPLETE LAMP | 55x41x41 | 2,8 | 4,2 |
| | OORT05043 | LAMPADA COMPLETA / COMPLETE LAMP | 55x41x41 | 2,8 | 4,2 |
| | OORT05035 | LAMPADA COMPLETA / COMPLETE LAMP | 65x41x41 | 3 | 4,7 |
| | OORT05045 | LAMPADA COMPLETA / COMPLETE LAMP | 65x41x41 | 3 | 4,7 |
| UOVO RIC. / REC. | F264600150BIBW | MONTATURA / MOUNTING DIFFUSORE / DIFFUSER | 15x10x15 24x40x24 | 0,2 1 | 0,3 1,5 |
| UOVO | F264613370BINE | MONTATURA / MOUNTING DIFFUSORE / DIFFUSER | 20x15x20 55x55x85 | 0,4 4,2 | 0,6 6 |













































ARREDO E VASI FURNITURE AND VASES









































| Famiglia Family | Codice Code | Descrizione Description | Dimensione Size cm A x B x H | Kg netto Kg net | Kg lordo Kg gross |
|---------------------------------------|----------------|----------------------------|---------------------------------|--------------------|----------------------|
| CARTOCCIO | F2910VA100OP10 | | 39x30x39 | 4,5 | 5,5 |
| | F2920VA100TR20 | | 39,5x36,5x39,5 | 4,5 | 5,5 |
| | F3010VA100TR10 | | 39,5x36,5x39,5 | 4,5 | 5,5 |
| FONTANA | F2600TB100TR00 | | 70x50x50 | 21 | 40 |
| | F2610TB100TR10 | | 130x50x70 | 36 | 60 |
| | F2620TB100TR20 | | 150x50x80 | 57 | 90 |
| TAVOLINO 1932 | F2710TB150TR10 | PIANO / TOP | 72x15x72 | 10 | 12 |
| | | STRUTTURA / STRUCTURE | 73x18x73 | 18 | 20 |
| TAVOLO CON RUOTE | F1000TB150TR00 | PIANO / TOP | 80x10x150 | 24 | 34 |
| | | RUOTE / WHEELS | 35x20x50 | 12 | 13 |
| | F1010TB150TR10 | PIANO / TOP | 160x10x110 | 52 | 62 |
| | | RUOTE / WHEELS | 35x20x50 | 12 | 13 |
| | F1110TB150TR00 | PIANO / TOP | 110x10x110 | 34,5 | 44,5 |
| | | RUOTE / WHEELS | 35x20x50 | 12 | 13 |
| F1120TB150TR20 | PIANO / TOP | 120x10x120 | 42 | 52 | |
| | RUOTE / WHEELS | 35x20x50 | 12 | 13 | |
| TESO (TAVOLO / TABLE) | F2720TA150TR20 | PIANO / TOP | 95x10x230 | 100 | 120 |
| | | RUOTE / WHEELS | 85x30x100 | 35 | 45 |
| | | | | | |
| TESO (LIBRERIA / BOOKCASE) | F2720LI150TR20 | STRUTTURA / STRUCTURE | 50x7x60 | 5 | 6 |
| | | MENSOLE / SHELVES | 45x20x250 | 85 | 100 |
| | | MONTANTI / UPRIGHTS | 45x50x45 | 30 | 35 |
| | | | | | |
| TOUR | F3010TA150TR10 | STRUTTURA / STRUCTURE | 23x8x50 | 4 | 5 |
| | | MENSOLE / SHELVES | 45x12x250 | 65 | 80 |
| | | MONTANTI / UPRIGHTS | 35x20x45 | 10 | 15 |
| | | PIANO / TOP | 125x5x125 | 57 | 58 |
| | | RUOTE / WHEELS | 55x50x55 | 15 | 16 |

TABELLA SORGENTI LUMINOSE / TABLE FOR LIGHTING SOURCE



























LAMPADE DA TAVOLO TABLE LAMPS

| Famiglia Family | Codice prodotto Product code | Lampadine consigliate Recommended light source | Etichetta energetica Energy Label |
|--------------------|---------------------------------|---|--------------------------------------|
| 3247 | F324700150KBNE |  LED 1x10,5W E27 (2700K, 1055Lm) or  HA 1x57W E27 (2800K, 915Lm) | A → G |
| | F324710150KBNE |  LED 1x14W E27 (2700K, 1521Lm) or  HA 1x100W E27 (2900K, 1800Lm) | A → G |
| ASHANGHAI | F418805150CBNE |  LED 3x6W E14 (2700K, 3x470Lm) or  HA 3x30W E14 (2700K, 3x405Lm) | A → G |
| BIANCA | F430810150BINE |  LED 1x21W E27 (2700K, 2452Lm) or  HA 1x116W E27 (2800K, 2135Lm) | A → G |
| BILIA MINI | F247400.....NE |  LED 1x6W G9 (2700K, 470Lm) | A → G |
| BILIA | F247405.....NE |  LED 1x6W E14 (2700K, 470Lm) or  HA 1x46W E14 (2700K, 700Lm) | A → G |
| BIS/TRIS | F228005150..NE |  LED 4x5,7W E14 (2700K, 4x470Lm) or  HA 4x30W E14 (2700K, 4x405Lm) | A → G |
| BLOM | F425305350..NE |  LED 1x5,7W E14 (2700K, 470Lm) | A → G |
| CHESHIRE | F425105350..NE |  LED 3x14W E27 (2700K, 3x1521Lm) | A → G |
| DARUMA | F502800100BINE |  LED 1x3,3W E27 (2700K, 250Lm) or  HA 1x20W E27 (2700K, 235Lm) | A → G |
| | F502805100BINE |  LED 1x8,5W E27 (2700K, 806Lm) or  HA 1x46W E27 (2700K, 700Lm) | A → G |
| | F502810100BINE |  LED 1x14W E27 (2700K, 1521Lm) or  HA 1x100W E27 (2900K, 1800Lm) | A → G |
| FALENA | F301705150CRNE |  HA 1x50W GY6.35 (3000K, 900Lm) | A → G |
| FONTANA | F185300100BINE |  LED 1x21W E27 (2700K, 2500Lm)  + LED 2x4W G9 (2700K, 2x400Lm) or  HA 1x46W E27 (2700K, 700Lm)  + HA 2x20W G9 (2700K, 2x235Lm) | A → G |
| | F185300200OTNE |  LED 1x21W E27 (2700K, 2500Lm) or  HA 1x100W E27 (2900K, 1800Lm) | A → G |
| | F185305100BINE |  LED 1x21W E27 (2700K, 2500Lm)  + LED 2x4,5W E14 (2700K, 2x470Lm) or  HA 1x100W E27 (2900K, 1800Lm)  + HA 2x30W E14 (2700K, 2x405Lm) | A → G |
| | F185305200OTNE |  LED 1x21W E27 (2700K, 2500Lm) or  HA 1x100W E27 (2900K, 1800Lm) | A → G |
| | F185310100BINE |  LED 1x21W E27 (2700K, 2500Lm)  + LED 4x4W E27 (2700K, 4x400Lm)  + LED 2x4,5W E14 (2700K, 2x470Lm) or  HA 1x100W E27 (2900K, 1800Lm)  + HA 4x46W E27 (2700K, 4x700Lm)  + HA 2x30W E14 (2700K, 2x405Lm) | A → G |
| FONTANELLA | F442305550..NE |  LED 1x6W E14 or  HA 1x28W E14 | A → G |
| | F442310550..NE |  LED 1x12W E27 or  HA 1x77W E27 | A → G |





























Questa tabella raccoglie le informazioni necessarie per l'acquisto corretto della fonte luminosa (esclusi i modelli con LED integrati).
La classe energetica del prodotto dipende dalla sorgente luminosa utilizzata.

| Famiglia Family | Codice prodotto Product code | Lampadine consigliate Recommended light source | Etichetta energetica Energy Label |
|--------------------|---------------------------------|---|--------------------------------------|
| GIOVA | F268405150..NE |  LED 1x8,5W E27 (2700K, 806Lm) or  HA 1x46W E27 (2700K, 700Lm) | A → G |
| | F268410150..NE |  LED 1x14W E27 (2700K, 1521Lm) or  HA 1x100W E27 (2900K, 1800Lm) | A → G |
| MANO | F420805400NENE |  LED 1x10,5W E27 (2700K, 1055Lm) or  HA 1x57W E27 (2800K, 915Lm) | A → G |
| METAFORA | F265405150BTNE |  LED 1x21W E27 (2700K, 2452Lm) or  HA 1x116W E27 (2800K, 2135Lm) | A → G |
| NASKA | F810010.....NE |  LED 1x9,5W E27 (2700K, 806Lm) or  HA 1x46W E27 (2700K, 700Lm) | A → G |
| | F810110.....NE |  LED 1x9,5W E27 (2700K, 806Lm) or  HA 1x46W E27 (2700K, 700Lm) | A → G |
| | F810700.....NE |  LED 1x5,7W E27 (2700K, 470Lm) or  HA 1x30W E27 (2700K, 405Lm) | A → G |
| PALLINA | F443000150..NE |  LED 1x6W G9 (2700K, 470Lm) | A → G |
| PAROLA | F265805100..NE |  LED 1x6W E14 (2700K, 470Lm) or  HA 1x46W E14 (2700K, 700Lm) | A → G |
| PASSION | F361000150..NE |  LED 1x3,5W G9 (2700K, 350Lm) or  HA 1x48W G9 (2800K, 740Lm) | A → G |
| | F361005150..NE |  LED 1x3,5W G9 (2700K, 350Lm) or  HA 1x48W G9 (2800K, 740Lm) | A → G |
| PINECONE | F436405.....NE |  LED 1x21W E27 (2700K, 2452Lm) or  HA 1x116W E27 (2800K, 2135Lm) | A → G |
| | F434010.....NE |  LED 1x21W E27 (2700K, 2452Lm) or  HA 1x116W E27 (2800K, 2135Lm) | A → G |
| PIRELLINA | F278205150KBNE |  LED 4x2,5W E14 (2700K, 250Lm) or  HA 4x20W E14 (2700K, 235Lm) | A → G |
| THOR | F329500100BINE |  LED 1x5,7W E14 (2700K, 470Lm) or  HA 1x30W E14 (2700K, 405Lm) | A → G |
| | F329505100BINE |  LED 1x9,5W E27 (2700K, 806Lm) or  HA 1x46W E27(2700K, 700Lm) | A → G |
| UOVO | F264600100BINE |  LED 1x5,5W E27 (2700K, 470Lm) or  HA 1x30W E27(2700K, 405Lm) | A → G |
| | F264605100BINE |  LED 1x10,5W E27 (2700K, 1055Lm) or  HA 1x70W E27(2800K, 1180Lm) | A → G |
| | F264610100BINE |  LED 1x14W E27 (2700K, 1521Lm) or  HA 1x100W E27 (2900K, 1800Lm) | A → G |
| | F264613370BINE |  LED 1x30W E27 | A → G |

















































LAMPADE DA TERRA FLOOR LAMPS

| Famiglia Family | Codice prodotto Product code | Lampadine consigliate Recommended light source | Etichetta energetica Energy Label |
|----------------------|---------------------------------|---|--------------------------------------|
| 0024 | F002430150TRNE |  LED 1x21W E27 (2700K, 2452Lm) or  HA 1x205W E27 (3000K, 4200Lm) | A → G |
| 3247 | F324725150KBNE |  LED 1x21W E27 (2700K, 2452Lm) or  HA 1x150W E27 (2900K, 2870Lm) | A → G |
| | F324730150KBNE |  LED 4x9W E27 (2700K, 4x806Lm) + LED 1x14W E27 (2700K, 1521Lm) or  HA 4x46W E27 (2700K, 4x600Lm) + HA 1x100W E27 (2900K, 1800Lm) | A → G |
| BIANCA | F430930150BINE |  LED 1x21W E27 (2700K, 2452Lm) or  HA 1x116W E27 (2800K, 2135Lm) | A → G |
| CHESHIRE | F425225350..NE |  LED 3x14W E27 (2700K, 3x1521Lm) | A → G |
| FALENA | F301825150CRNE |  HA 1x50W GY6.35 (3000K, 900Lm) | A → G |
| FLÛTE | F330025150TCNE |  LED 1x21W E27 (2700K, 2452Lm) or  HA 1x205W E27 (3000K, 4200Lm) | A → G |
| | F330030150TCNE |  HA 1x230W R7s/115 (3000K, 8750Lm) | A → G |
| LUMEN | F248225150BINE |  LED 4x9W E27 (2700K, 4x806Lm) + LED 1x14W E27 (2700K, 1521Lm) or  HA 4x46W E27 (2700K, 4x700Lm) + HA 1x100W E27 (2900K, 1800Lm) | A → G |
| PAROLA | F265925100..NE |  LED 1x12W E14 (2700K, 470Lm) or  HA 1x46W E14 (2700K, 700Lm) | A → G |
| PAROLONA | F275130150BINE |  LED 1x12W E14 (2700K, 470Lm) or  HA 1x46W E14 (2700K, 700Lm) | A → G |
| PASSION | F361125150CRNE |  LED 2x14W E27 (2700K, 2x1521Lm) or  HA 2x100W E27 (2900K, 2x1800Lm) | A → G |
| PIRELLONE | F275930150KBNE |  LED 10x3,5W G9 (2700K, 10x350Lm) + HA 1x230W R7s/115 or  HA 10x33W G9 (2700K, 10x460Lm) + HA 1x230W R7s/115 | A → G |
| PRIMA SIGNORA | F289130150CBNE |  LED 1x21W E27 (2700K, 2452Lm) or  HA 1x205W E27 (3000K, 4200Lm) | A → G |
| SCINTILLA | F272930250..NE |  HA 1x230W R7s/115 (2900K, 5000Lm) | A → G |
| TRIPOD | F439825150NENE |  HA 1x105W E27 + LED 2x7W GU10 | A → G |







LAMPADE A PARETE E A PLAFONE WALL AND CEILING LAMPS

| Famiglia Family | Codice prodotto Product code | Lampadine consigliate Recommended light source | Etichetta energetica Energy Label |
|--------------------|---------------------------------|---|--------------------------------------|
| BIANCA | F432870150BINE |  LED 1x21W E27 (2700K, 2452Lm) or  HA 1x116W E27 (2800K, 2135Lm) | A → G |
| BRUCO | F353845100BINE |  LED 1x6W E14 (2700K, 470Lm) or  HA 1x46W E14 (2700K, 700Lm) | A → G |
| FALENA | F301945150CRNE |  HA 1x50W GY6.35 (3000K, 900Lm) | A → G |
| FONTANELLA | F442305550..NE |  LED 1x6W E14 or  HA 1x28W E14 | A → G |
| | F442310550..NE |  LED 1x12W E27 or  HA 1x77W E27 | A → G |
| NASKA | F447745.....NE |  LED 1x9,5W E27 (2700K, 806Lm) or  HA 1x46W E27 (2700K, 700Lm) | A → G |
| | F447750.....NE |  LED 1x5,7W E27 (2700K, 470Lm) or  HA 1x30W E27 (2700K, 405Lm) | A → G |
| PALLINA | F443060150..NE |  LED 1x6W G9 (2700K, 470Lm) | A → G |
| PANGEN | F419766350..NE |  LED 3x9W E27 (2700K, 900Lm) or  HA 3x46W E27 (2700K, 2100Lm) | A → G |
| PAROLA | F268945150..NE |  LED 1x6W E14 (2700K, 470Lm) or  HA 1x46W E14 (2700K, 700Lm) | A → G |
| SCINTILLA | FP15045250..NE |  HA 1x120W R7s/80 (2900K, 2250Lm) | A → G |
| | FP30050250..NE |  HA 1x230W R7s/115 (2900K, 5000Lm) | A → G |
| SILLABA | F277560150BINE |  LED 1x2,4W G4 (2700K, 300Lm) or  HA 1x20W G4 (2800K, 320Lm) | A → G |
| | F277565150BINE |  LED 1x2,4W GY6.35 (2700K, 300Lm) or  HA 1x50W GY6.35 (3000K, 900Lm) | A → G |
| | F277570150BINE |  LED 1x3,8W G9 (2700K, 470Lm) or  HA 1x60W G9 (2800K, 980Lm) | A → G |
| SILLABONE | F279370150BINE |  LED 1x14W E27 (2700K, 1521Lm) or  HA 1x100W E27 (2800K, 1800Lm) | A → G |

LAMPADE A SOSPENSIONE SUSPENSION LAMPS

| Famiglia Family | Codice prodotto Product code | Lampadine consigliate Recommended light source | Etichetta energetica Energy Label |
|----------------------|---------------------------------|--|--------------------------------------|
| 0024 | F002485150TRNE |  FL 2x36W 2G11 | A → G |
| | F002490150TRNE |  FL 4x54W G5 | A → G |
| AMAX | F544480350BINE |   LED 1x14W E27 (2700K, 1521Lm) or HA 1x100W E27 (2900K, 1800Lm) | A → G |
| | F544485350BINE |   LED 1x21W E27 (2700K, 2452Lm) or HA 1x150W E27 (2900K, 2870Lm) | A → G |
| | F544490350BINE |   LED 3x14W E27 (2700K, 1521Lm) or HA 3x100W E27 (2900K, 1800Lm) | A → G |
| | F544495350BINE |   LED 3x21W E27 (2700K, 2452Lm) or HA 3x150W E27 (2900K, 2870Lm) | A → G |
| AVICO | F556180350..NE |   LED 3x14W E27 (2700K, 1521Lm) or HA 3x100W E27 (2900K, 1800Lm) | A → G |
| | F556185350..NE |   LED 3x21W E27 (2700K, 2452Lm) or HA 3x150W E27 (2900K, 2870Lm) | A → G |
| BIANCA | F430690150BINE |   LED 1x21W E27 (2700K, 2452Lm) or HA 1x116W E27 (2800K, 2135Lm) | A → G |
| BOLLA | F354085100TRNE |   LED 1x14W E27 (2700K, 1521Lm) or HA 1x77W E27 (2800K, 1320Lm) | A → G |
| | F354090100TRNE |   LED 1x14W E27 (2700K, 1521Lm) or HA 1x77W E27 (2800K, 1320Lm) | A → G |
| CHANDELIER | F549180250..NE |   LED 14x4W E14 (2700K, 6580Lm) or HA 14x40W E14 (2700K, 6860Lm) | A → G |
| | F549185250..NE |   LED 19x4W E14 (2700K, 8930Lm) or HA 19x40W E14 (2700K, 9310Lm) | A → G |
| | F549190250..NE |     LED 8x4W E14 (2700K, 3760Lm) + LED 14x4W E14 (2700K, 6580Lm) or HA 8x40W E14 (2700K, 3920Lm) + HA 14x40W E14 (2700K, 6860Lm) | A → G |
| | F549195250..NE |     LED 14x4W E14 (2700K, 6580Lm) + LED 19x4W E14 (2700K, 8930Lm) or HA 14x40W E14 (2700K, 6580Lm) + HA 19x40W E14 (2700K, 8930Lm) | A → G |
| CHESHIRE | F425785350..NE |  LED 3x14W E27 (2700K, 1521Lm) | A → G |
| FLÛTE | F333795150TCNE |  HA 1x230W R7s/M15 (2900K, 5000Lm) | A → G |
| GLOBO DI LUCE | F364480150..NE |   LED 1x3,5W E14 (2700K, 230Lm) or HA 1x40W E14 (2800K, 250Lm) | A → G |
| | F364485150..NE |   LED 1x3,5W G9 (2700K, 350Lm) or HA 1x60W G9 (2800K, 980Lm) | A → G |
| | F364490150..NE |   LED 1x21W E27 (2700K, 2452Lm) or HA 1x150W E27 (2900K, 2870Lm) | A → G |
| HUNA | F505985200..NE |   LED 1x21W E27 (2700K, 2452Lm) or HA 1x116W E27 (2800K, 2135Lm) | A → G |
| LAMPARA | F500090200..NE |   LED 1x21W E27 (2700K, 2452Lm) or HA 1x116W E27 (2800K, 2135Lm) | A → G |
| PALLINA | F443080150..NE |  LED 1x6W G9 (2700K, 470Lm) | A → G |
| PANGEN | F419685350..NE |   LED 3x9W E27 (2700K, 300Lm) or HA 3x46W E27 (2700K, 700Lm) | A → G |
| PAROLA | F428485100..NE |  LED 1x3,5W G9 (3000K, 400Lm) | A → G |

Questa tabella raccoglie le informazioni necessarie per l'acquisto corretto della fonte luminosa (esclusi i modelli con LED integrati).
La classe energetica del prodotto dipende dalla sorgente luminosa utilizzata.

| Famiglia Family | Codice prodotto Product code | Lampadine consigliate Recommended light source | Etichetta energetica Energy Label |
|--------------------|---------------------------------|---|--------------------------------------|
| PINECONE | F436385550..NE |  LED 1x21W E27 (2700K, 2452Lm) or  HA 1x116W E27 (2800K, 2135Lm) | A → G |
| | F433990550..NE |  LED 1x21W E27 (2700K, 2452Lm) or  HA 1x116W E27 (2800K, 2135Lm) | A → G |
| SCINTILLA | FS15085250..NE |  HA 1x120W R7s/80 (2900K, 2250Lm) | A → G |
| | FS30090250..NE |  HA 1x230W R7s/115 (2900K, 5000Lm) | A → G |

LEGENDA / LEGEND



Marchatura obbligatoria che attesta la conformità del prodotto alle disposizioni delle direttive e regolamenti comunitari.
Mandatory marking certifying the conformity of the product to the community directives and rules.



Il Certificato di conformità EAC (EurAsian Conformity) indica che i prodotti si adeguano a tutte le normative tecniche delle procedure di valutazione dell'Unione doganale eurasiatica.
The EurAsian Conformity mark (EAC) is a certification mark to indicate that the products conform to all technical regulations of the Eurasian Customs Union.



Marchio di certificazione per il mercato nord americano che certifica che il prodotto è conforme e rispetta i requisiti delle normative nordamericane.
Mark of certification for the american market that certifies that the product is conform to the North American standards.



Marchio di Certificazione Cinese.
China Compulsory Certification.



Indice di protezione contro la penetrazione di corpi solidi e di liquidi.
Protection degree offered by the fixture to the ingress of solids and liquids.



La prima cifra indica, protezione contro la penetrazione di corpi solidi:

- (0) Nessuna protezione
 - (1) Protezione contro i corpi solidi di dimensioni superiori a 50mm
 - (2) Protezione contro i corpi solidi di dimensioni superiori a 12mm
 - (3) Protezione contro i corpi solidi di dimensioni superiori a 2,5mm
 - (4) Protezione contro i corpi solidi di dimensioni superiori a 1mm
 - (5) Protezione contro la polvere
 - (6) Totalmente protetto contro la polvere.
- The first number is the protection rating against solid objects:
- (0) No protection
 - (1) Protected against solid bodies over 50 mm in diameter
 - (2) Protected against solid bodies over 12 mm in diameter
 - (3) Protected against solid bodies over 2,5 mm in diameter
 - (4) Protected against solid bodies over 1 mm in diameter
 - (5) Protected against dust
 - (6) Fully protected against dust.



La seconda cifra indica, protezione contro l'infiltrazione di acqua:

- (0) Nessuna protezione
 - (1) Protezione contro la caduta in verticale di gocce d'acqua
 - (2) Protezione contro la caduta in verticale di gocce d'acqua con angolo di inclinazione massimo di 15°
 - (3) Protezione contro la caduta in verticale di gocce d'acqua con angolo di inclinazione massimo di 60°
 - (4) Protezione contro gli spruzzi d'acqua
 - (5) Protezione contro i getti d'acqua
 - (6) Protezione contro le ondate d'acqua
 - (7) Protezione contro l'immersione
 - (8) Protezione contro l'immersione prolungata.
- The second number is the protection against liquids:
- (0) No protection
 - (1) Protected against drops of water falling vertically
 - (2) Protected against drops of water at a max. inclination of 15 degrees
 - (3) Protected against drops of water at a max. inclination of 60 degrees
 - (4) Protected against splashed of water
 - (5) Protected against jets of water
 - (6) Protected against waves
 - (7) Protected against immersion
 - (8) Protected against long term immersion.

Classe II



Apparecchio in cui la protezione contro la scossa elettrica non si basa unicamente sull'isolamento principale, ma anche su misure supplementari di sicurezza quali il doppio isolamento o l'isolamento rinforzato. Questi apparecchi non prevedono la messa a terra.
Light fittings whose safety is guaranteed only by the double and / or reinforced insulation of all parts, with no earth.

Classe III



Apparecchio in cui la protezione contro la folgorazione elettrica si basa sull'alimentazione a bassissima tensione e in cui non si producono tensioni superiori alla stessa (SELV).
Light fitting fitted with a protection device against electric shock that features a very low voltage power supplied and prevents it from generating higher voltages (SELV).

CRI

Indice di resa cromatica.
Colour rendering index.



VETRO SOFFIATO
BLOWN GLASS

Il procedimento per dare una forma al vetro è la soffiatura: libera o a stampo. La tecnica di soffiatura può essere variata utilizzando stampi di ferro, bronzo o legno bagnato. In queste forme viene soffiata la massa vitrea, ripetutamente scaldata, che si modella dilatandosi e sagomandosi. La soffiatura del vetro è un'arte che non ha età.

The procedure for shaping glass is blowing: free or moulded. The blowing technique can be varied by using moulds made of iron, bronze or wet wood. Into these forms the heated glass mass is blown and shaped by expanding. Glassblowing is an ageless art.



Prodotto disponibile anche in versione da tavolo
Product also available in table version



Prodotto disponibile anche in versione da terra
Product also available in floor version



Prodotto disponibile anche in versione a plafone
Product also available in ceiling version



Prodotto disponibile anche in versione a parete
Product also available in wall version



Prodotto disponibile anche in versione a sospensione
Product also available in suspension version

NOTE TECNICHE DIMMER

Dimmer: apparecchio dimmerabile tramite pulsante presente sulla lampada o sul cavo (infrarad, microswitch, push button, slider control, touch).

Dimmerabile (si): apparecchio dimmerabile tramite pulsante remoto adatto a gestire sorgenti dimmerabili (alogene, fluorescenti, LED retrofit).

Dimmerabile (Push): apparecchio dimmerabile tramite pulsante remoto adatto a gestire driver di tipo Push.

Dimmerabile (1-10V): apparecchio dimmerabile tramite pulsante remoto adatto a gestire driver di tipo 1-10V.

Dimmerabile a taglio di fase: apparecchio dimmerabile solo con dimmer per moduli LED a tensione di rete.

Dimmerabile TRIAC: I dimmer TRIAC più recenti possono dimmerare lampade a LED

DIMMER TECHNICAL NOTES

Dimmer: dimmable fixture by means of a switch situated on the lamp structure or on cable (infrared, microswitch, push button, slider control, touch).

Dimmable (yes): dimmable fixture by means of a remote switch able to manage dimmable sources (halogens, fluorescents, LED Retrofit).

Dimmable (Push): dimmable fixture by means of a remote switch able to manage Push Drivers.

Dimmable (1-10V): dimmable fixture by means of a remote switch able to manage 1.10V Drivers.

Dimmable with phase cut dimmer: dimmable fixture only with dimmer for LED modules for mains voltage.

Dimmerabile TRIAC: The latest TRIAC dimmers can dim LED lamps

CONDIZIONI DI VENDITA / SALES CONDITION

DIRETTIVA RAEE RIFIUTI APPARECCHIATURE ELETTRICHE E ELETTRONICHE

Il 14 Marzo 2014 il Consiglio dei Ministri ha recepito con il Decreto Legislativo nr. 49/2014 la nuova Direttiva Europea EU 2012/19/UE relativa alla raccolta e smaltimento dei rifiuti derivati da apparecchiature elettriche ed elettroniche. La modalità con la quale il Decreto ha messo a disposizione dei produttori di apparecchiature elettriche e elettroniche la possibilità di finanziare le attività di recupero e smaltimento dei rifiuti derivanti da tali apparecchiature è denominata eco-contributo; modalità che viene utilizzata da tutti i produttori aderenti al consorzio Ecolight, tra i quali FontanaArte. L'eco-contributo RAEE è incorporato nel prezzo di vendita. Gli esportatori abituali ed occasionali sono esenti dall'eco-contributo RAEE.

Numero iscrizione Registro Apparecchiature Elettriche e Elettroniche: IT612000009612 (AEE) / DE37033037 (EAR)

CONDIZIONI GENERALI DI VENDITA AL CLIENTE RIVENDITORE

- Le presenti condizioni generali di vendita ("Condizioni") sostituiscono ed annullano le precedenti edizioni, disciplinano i rapporti contrattuali instaurati tra FontanaArte S.p.A. ("FontanaArte") e i rispettivi rivenditori, aventi a oggetto la fornitura di prodotti FontanaArte ("Prodotti"), come di volta in volta indicati nell'ordine di acquisto ("Ordine") emesso - in qualsiasi forma e con qualsiasi mezzo - dal rivenditore e confermato da FontanaArte.
- Le seguenti Condizioni - indicate in listino e di volta in volta aggiornate e caricate sul sito web www.fontanaarte.com - vengono integralmente e automaticamente accettate dal rivenditore con trasmissione in qualsiasi forma e su qualsiasi supporto dell'Ordine dal rivenditore a FontanaArte. Con la trasmissione dell'Ordine il rivenditore conferma, quindi, di conoscere ed accettare le Condizioni. È esclusa l'applicazione di ogni altro termine, condizione o previsione del rivenditore. Qualora il rivenditore non condividesse alcuni dei termini riportati nelle Condizioni, FontanaArte invita il rivenditore medesimo a non inoltrare l'Ordine per l'acquisto dei Prodotti. Al momento dell'invio di qualsiasi Ordine da parte del rivenditore a FontanaArte, sarà onere e cura del rivenditore medesimo verificare il contenuto delle Condizioni come di volta in volta aggiornate da FontanaArte e da quest'ultima pubblicate sul proprio sito web sopra indicato.
- FontanaArte si riserva il diritto in qualsiasi momento di eliminare i Prodotti dalle proprie collezioni o cataloghi e di apportare variazioni di prezzo o altre modifiche derivanti da esigenze tecniche o commerciali. Dette variazioni non troveranno applicazione per i Contratti, come definiti sotto, già conclusi prima della notifica della relativa variazione, da parte di FontanaArte al rivenditore.
- La fornitura avviene sempre ai prezzi indicati nel listino di FontanaArte ed alle condizioni in vigore alla data della conferma d'Ordine. Salvo quanto diversamente concordato tra le parti, non sono effettuati riduzioni o sconti sul valore dei prezzi di listino.
- L'emissione di qualsiasi Ordine costituisce una proposta contrattuale, dal rivenditore a FontanaArte, di acquistare i Prodotti ai sensi delle presenti Condizioni. L'Ordine si ritiene accettato solo ove FontanaArte (a) emetta una conferma d'Ordine scritta o (b) proceda con la fornitura dei Prodotti, ai sensi dell'Ordine, considerandosi tale fatto quale accettazione tacita.
- Qualora la conferma d'Ordine emessa da FontanaArte rechi qualsiasi modifica rispetto al contenuto del relativo Ordine (ivi incluse le presenti Condizioni), la conferma dell'Ordine sarà automaticamente considerata quale nuova proposta contrattuale, formulata da FontanaArte, che dovrà essere accettata dal rivenditore. Non si accettano annullamenti di Ordini già trasmessi e confermati a meno di un accordo scritto tra le parti.
- Il contratto tra FontanaArte e il rivenditore per la fornitura dei Prodotti ("Contratto" - il Contratto è formato dalle Condizioni e dall'Ordine accettato da FontanaArte ovvero dalla contro proposta di FontanaArte accettata dal rivenditore) si intende concluso (i) alla data di accettazione scritta dell'Ordine da parte di FontanaArte; o (ii) nel tempo in cui ha avuto inizio l'esecuzione (in caso di accettazione tacita nei termini di cui sopra) in caso di accettazione della controproposta da parte del rivenditore.
- Il rivenditore è tenuto a controllare la correttezza della conferma d'Ordine e delle condizioni, incluse le condizioni di vendita e di pagamento, ivi indicate.
- I Prodotti saranno consegnati secondo le modalità e nel luogo indicati nell'Ordine confermato ("Luogo di Consegna"). Salvo ove diversamente convenuto tra le parti,

la consegna dei Prodotti è effettuata presso il Luogo di Consegna alle condizioni riportate di seguito:

- Franco destino per ordini di valore superiore a € 1.000,00;
- Addebito percentuale del 7% sul valore imponibile da € 500,00 a € 1.000,00;
- Addebito in fattura di € 50,00 per ordini fino a € 500,00.

Le condizioni sopracitate sono valide per i seguenti paesi:

Italia, Francia, Spagna (escluse isole), Austria, Svizzera, Germania, Belgio, Lussemburgo, Paesi Bassi e Slovenia. Per gli altri paesi consultare il Customer Service.

- Il trasferimento del rischio dal Fornitore al rivenditore avviene dal momento della consegna dei Prodotti nel Luogo di Consegna. Dal quel momento grava sul rivenditore il rischio di perimento, smarrimento o danneggiamento dei Prodotti.
- Il rivenditore potrà rivendere i Prodotti ai clienti finali nello svolgimento ordinario della sua attività imprenditoriale. È vietata la vendita dei Prodotti a soggetti che li acquistino per la rivendita.
- I Prodotti FontanaArte sono garantiti per 2 anni. I reclami relativi ad eventuali Prodotti difettosi potranno essere accettati e la conseguente procedura per resi e sostituzioni dei Prodotti o delle parti difettose di questi ultimi potrà essere attivata solo dietro la presentazione della copia del documento fiscale attestante il relativo acquisto, e corretta compilazione dell'apposito modulo di reclamo. Non si accettano reclami notificati a FontanaArte dopo 8 giorni dal ricevimento dei Prodotti.
- Non si accettano resi se non preventivamente autorizzati per iscritto da FontanaArte. Il reso dei Prodotti dovrà essere effettuato unicamente tramite lo spedizioniere ufficiale indicato da FontanaArte che sarà preventivamente, senza alcun accredito, autorizzato ad effettuare il ritiro. I Prodotti devono essere resi negli imballi originali. Al ricevimento dei Prodotti resi, il reparto resi clienti di FontanaArte effettuerà un controllo di detti Prodotti. In caso di riscontro di difetti di produzione la sostituzione dei Prodotti verrà effettuata a titolo gratuito. Qualora il difetto riscontrato non possa essere considerato come un vizio di produzione, i Prodotti resteranno a disposizione per il ritiro da parte del rivenditore per 30 giorni dalla data in cui è stato comunicato l'esito del controllo al rivenditore. Trascorso tale termine senza istruzioni da parte del rivenditore, detti Prodotti verranno distrutti senza che il rivenditore abbia diritto ad alcunché in relazione a quanto precede.
- Salvo dolo o colpa grave e qualsiasi altra ipotesi di responsabilità che non può essere esclusa o limitata ai sensi delle disposizioni inderogabili di legge, FontanaArte non sarà responsabile nei confronti del rivenditore per un importo superiore al prezzo pagato dal rivenditore ai sensi di ciascun Contratto e/o per qualunque tipo di danni indiretti.
- FontanaArte ha la facoltà di sospendere la fornitura dei Prodotti quando le condizioni finanziarie o patrimoniali del rivenditore risultino tali da porre in evidente pericolo o il conseguimento del pagamento dovuto o per altri motivi di carattere commerciale e di gestione di FontanaArte.
- Il mancato o ritardato pagamento dei corrispettivi dovuti a FontanaArte dal rivenditore nei termini previsti dal Contratto comporta un addebito di interessi pari all'3% sull'ammontare di ciascuna fattura relativa ai Prodotti acquistati per ogni mese di ritardo dalla scadenza indicata nel Contratto.
- FontanaArte si riserva il diritto di modificare qualsiasi delle precedenti clausole a proprio insindacabile giudizio e senza obbligo di fornire preavviso al rivenditore, restando inteso che ciascuna modifica entrerà in vigore con riferimento a qualsiasi Contratto concluso successivamente all'avenuta notifica, da parte di FontanaArte al rivenditore mediante pubblicazione delle Condizioni aggiornate sul sito web di FontanaArte, della modifica medesima.
- Ciascun Contratto è regolato e interpretato ai sensi della legge della Repubblica Italiana.
- Per ogni controversia che dovesse insorgere tra le parti in relazione a ciascun Contratto è competente in via esclusiva il Tribunale di Milano.

WEEE DIRECTIVE ON WASTE FROM ELECTRICAL AND ELECTRONIC EQUIPMENT

On 14 March 2014 the Council of Ministers ratified with Legislative Decree No. 49/2014 the new European Directive 2012/19/EU on the collection and disposal of waste from electrical and electronic equipment. The mechanism introduced with the Decree by which manufacturers of electrical and electronic equipment may finance the recovery and disposal of waste from such equipment is called the eco-contribution.

The mechanism has been adopted by all manufacturers belonging to the Ecolight consortium, among them FontanaArte.

The WEEE eco-contribution is included in the sale price.

Routine and occasional exporters are exempt from the WEEE eco-contribution.

ELECTRICAL AND ELECTRONIC EQUIPMENT Registration Number: IT612000009612 (AEE) / DE37033037 (EAR)

GENERAL TERMS AND CONDITIONS OF SALE FOR RETAILERS

- These general terms and conditions of sale ("Conditions") replace and nullify any previous versions governing the contractual relationships between FontanaArte S.p.A. ("FontanaArte") and the respective retailers regarding the supply of FontanaArte products ("Products"), as indicated in the purchase orders ("Order") issued - in whatever form and by any means - by the retailer and confirmed by FontanaArte.
- The following Conditions – specified in the price list and from time to time updated and uploaded to the web site www.fontanaarte.com are fully and automatically accepted by the retailer when it sends the purchase order, in whatever form and on whatever support, to FontanaArte. With the sending of the Purchase Order the retailer therefore confirms that it understands and accepts the Conditions. Any other terms, conditions or provisions of the retailer are excluded. Should the retailer not agree with any of the terms and conditions, FontanaArte would ask the retailer not to send a Purchase Order for the Products. Whenever the retailer sends FontanaArte a Purchase Order, it is the retailer's duty and responsibility to check the terms and conditions from time to time updated by FontanaArte and published on their web site.
- FontanaArte reserves the right at any time to remove Products from its collections or catalogues and to make price changes or other changes due to technical or commercial demands. These variations shall not apply to any Contracts, as defined below, that have already been concluded prior to the retailer's notification of the change by FontanaArte.
- The Products are always supplied at the prices indicated in the FontanaArte price list and at the conditions prevailing at the date of Order confirmation. Unless otherwise agreed between the parties, there shall be no reductions or discounts on the listed price.
- The issue of an Order represents a contractual proposal by the retailer to FontanaArte to purchase the Products under these Conditions. The Order is deemed to be accepted if FontanaArte (a) issues a written Order confirmation or (b) proceeds with the supply of the Products as indicated on the Order, this being taken as tacit acceptance.
- Should the Order confirmation issued by FontanaArte carry any variation with respect to the content of the Order (including these Conditions), the Order confirmation will automatically be considered a new contractual proposal by FontanaArte, which the retailer shall accept. Orders already transmitted and confirmed may not be cancelled except by written agreement between the parties.
- The contract between FontanaArte and the retailer for supply of the Products ("Contract" – the Contract is made up of the Conditions and the Order accepted by FontanaArte or by a counter-proposal by FontanaArte and accepted by the retailer) is understood to the concluded (i) at the date of written acceptance of the Order by FontanaArte; or (ii) at the moment execution begins (in the event of tacit acceptance as described above) and in the event of acceptance of a counter-proposal by the retailer.
- The retailer is required to check the accuracy of the Order confirmation and the Conditions, including the conditions of sales and payment specified therein.
- The Products shall be delivered in accordance with the procedures and in the places specified in the confirmed Order ("Place of Delivery"). Unless otherwise agreed between the parties, the Products will be delivered to the Place of Delivery at the following conditions:

- Free at destination for orders worth more than € 1.000,00;
- 7% charge on the taxable value from € 500,00 to € 1.000,00;
- € 50 charge on the invoice for orders of up to € 500.

The above-mentioned conditions are valid for the following countries:

Italy, France, Spain (excluding islands), Austria, Switzerland, Germany, Belgium, Luxembourg, the Netherlands and Slovenia. For other countries please consult Customer Service.

- The transfer of risk from Supplier to retailer occurs at the moment of delivery of the Products to the Place of Delivery. From that moment the retailer shall bear the risk of destruction of, loss of, or damage to, the Products.
- The retailer may resell the Products to end clients in the normal course of their business. It is forbidden to sell the Products to subjects that purchase them for resale.
- FontanaArte Products are guaranteed for 2 years. Claims regarding defective Products may be accepted and the ensuing procedure for the return and replacement of the Products or defective parts of same may be activated only on submission of a copy of the tax document attesting the order, and the correctly compiled claim form. Claims received by FontanaArte beyond 8 days after receipt of the Products will not be accepted.
- No returns will be accepted unless authorized in writing in advance by FontanaArte. Product returns shall be made exclusively by the official shipping agent named by FontanaArte who is authorized in advance to make the collection, without accreditation. Products must be returned in the original packaging. On receipt of the returned Products, the FontanaArte customer returns department will check the said Products. If production defects are found the Products will be replaced free of charge. Should the defect be deemed not to be a production defect, the Products will remain available for collection by the retailer for 30 days after the outcome of the check is communicated to the retailer. After that date, unless instructions are received from the retailer, the Products will be destroyed and the retailer will not be entitled to any reimbursement.
- Save criminal intent, or serious misconduct or any other liability that cannot be excluded or limited by binding provision of the law, FontanaArte shall not be liable to the retailer for an amount greater than the price paid by the retailer under the Contract or for any form of indirect damages.
- FontanaArte is entitled to suspend supply of the Products if the retailer's financial or capital circumstances are such as to clearly put at risk payment of the amounts due or for any other reasons on the part of FontanaArte of a commercial or business nature.
- Failure to pay or late payment of the amount due to FontanaArte by the retailer within the terms set forth in the Contract will entail a 3% interest charge on the amount invoiced for each Product purchase for each month's delay beyond the expiry date specified in the Contract.
- FontanaArte reserves the right to modify any of above clauses at its unchallengeable discretion and without the obligation of advance notice to the retailer, it being understood that any change will come into effect in Contracts concluded subsequent to communication of the change to the retailer by FontanaArte possibly via publication of the modified terms and conditions on FontanaArte's web site.
- Each Contract shall be governed and interpreted in accordance with Italian law.
- For any dispute that may arise between the parties in relation to any Contract the Courts of Milan shall have exclusive jurisdiction.

DIRECTIVE SUR LES DÉCHETS D'ÉQUIPEMENTS ÉLECTRIQUES ET ÉLECTRONIQUES (DEEE)

Le 14 mars 2014, le Conseil des ministres [de la République italienne] a adopté le décret législatif n° 49/2014, lequel transpose la nouvelle directive européenne 2012/19/UE sur la collecte et l'élimination des déchets d'équipements électriques et électroniques. La manière dont le décret a mis à la disposition des producteurs d'équipements électriques et électroniques la possibilité de financer la valorisation et l'élimination des déchets de ces équipements est appelée écocontribution, une méthode qui est utilisée par tous les producteurs appartenant au consortium Ecolight, dont FontanaArte. L'écocontribution DEEE est incorporée dans le prix de vente. Les exportateurs réguliers et occasionnels sont exemptés de l'écocontribution DEEE.

Numéro d'enregistrement au Registre pour les équipements électriques et électroniques: IT612000009612 (AEE) / DE37033037 (EAR)

CONDITIONS GÉNÉRALES DE VENTE POUR LE REVENDEUR

- Les présentes conditions générales de vente (« Conditions ») remplacent et annulent les éditions précédentes ; elles régissent les relations contractuelles établies entre la société FontanaArte S.p.A. (« FontanaArte ») et ses revendeurs, ayant pour objet la fourniture de produits FontanaArte (« Produits »), comme indiqué au cas par cas dans le bon de commande (« Commande ») émis - sous n'importe quelle forme et avec tout moyen quel qu'il soit - par le revendeur.
 - Les suivantes Conditions – indiquées sur le catalogue de prix, mises à jour au cas par cas et insérées sur le site Internet www.fontanaarte.com sont acceptées intégralement et automatiquement par le revendeur dès que ce dernier transmet, sous n'importe quelle forme et sur tout support quel qu'il soit, une Commande à FontanaArte. En transmettant une Commande, le revendeur confirme donc qu'il connaît les conditions et qu'il les accepte. L'application de tout autre terme, condition ou prévision du revendeur est exclue. Au cas où le revendeur ne serait pas d'accord avec certains termes indiqués dans les Conditions, FontanaArte invitera ledit revendeur à ne pas envoyer de Commande d'achat de Produits. Au moment où le revendeur enverra toute Commande quelle qu'elle soit à FontanaArte, il sera tenu de vérifier le contenu des Conditions mises à jour au cas par cas par la société FontanaArte et publiées par cette dernière sur le site Web mentionné ci-dessus.
 - FontanaArte se réserve le droit, à tout moment, de retirer des produits de ses collections ou catalogues et d'effectuer des changements de prix ou d'autres modifications résultant de besoins techniques ou commerciaux. Ces modifications ne s'appliqueront pas aux Contrats, tels que définis ci-dessous, déjà conclus avant la notification de la modification par FontanaArte au revendeur.
 - La livraison s'effectue toujours aux prix indiqués dans le tarif FontanaArte et selon les conditions en vigueur à la date de la confirmation de la Commande. Sauf accord contraire convenu entre les parties, aucune réduction ou rabais n'est accordé sur la valeur des prix du catalogue.
 - L'émission de toute commande constitue une proposition contractuelle, transmise à FontanaArte par le revendeur, d'acheter les Produits conformément aux présentes Conditions. La Commande n'est considérée comme acceptée que si FontanaArte (a) délivre une confirmation de Commande écrite ou (b) procède à la fourniture des Produits, conformément à la Commande, considérant ce fait comme une acceptation tacite.
 - Si la confirmation de Commande émise par FontanaArte fait apparaître une modification du contenu de la Commande concernée (y compris les présentes Conditions), la confirmation de Commande sera automatiquement considérée comme une nouvelle proposition contractuelle, formulée par FontanaArte, qui devra être acceptée par le revendeur. Les annulations de commandes déjà envoyées et confirmées ne seront pas acceptées sauf accord écrit entre les parties.
 - Le contrat entre FontanaArte et le revendeur pour la fourniture des Produits (« Contrat ») - le Contrat se compose des Conditions et de la Commande acceptée par FontanaArte ou de la contre-proposition de FontanaArte acceptée par le revendeur) est réputé conclu (i) à la date de l'acceptation écrite de la Commande par FontanaArte; ou (ii) au moment où l'exécution commence (en cas d'acceptation tacite aux conditions énoncées ci-dessus) et en cas d'acceptation de la contre-proposition de la part du revendeur.
 - Le revendeur est tenu de vérifier l'exactitude de la confirmation de Commande et des Conditions, y compris les conditions de vente et de paiement, qui y sont indiquées.
 - Les Produits seront livrés de la manière et au lieu indiqués dans la Commande confirmée (« Lieu de livraison »). Sauf accord contraire entre les parties, la livraison des Produits est effectuée au Lieu de livraison selon les conditions définies ci-après :
 - Franco destination pour les commandes d'une valeur supérieure à 1.000,00 € ;
 - Frais de 7% sur la valeur imposable de 500,00 € à 1.000,00 € ;
 - Majoration de la facturation de 50,00 € pour les commandes jusqu'à 500,00 €.
- Les conditions ci-dessus sont valables pour les pays suivants : Italie, France, Espagne (à l'exclusion des Isles), Autriche, Suisse, Allemagne, Belgique, Luxembourg, Pays-Bas et Slovénie
- Le transfert des risques du Fournisseur au revendeur a lieu à partir du moment où les Produits sont livrés au Lieu de livraison. À partir de ce moment, le risque de destruction, de perte ou d'endommagement des Produits est à la charge du revendeur
 - Le revendeur peut revendre les produits à des clients finaux dans le cadre de ses activités. Il est interdit de vendre les Produits à des personnes les achetant dans le but de les revendre.
 - Les produits FontanaArte sont garantis 2 ans. Les réclamations relatives à d'éventuels Produits défectueux pourront être acceptées et la procédure conséquentaire pour les retours et les remplacements des Produits ou des pièces défectueuses de ces dernières, pourra être activée seulement après la présentation de la copie du document fiscal attestant l'achat en question et la compilation correcte du formulaire de réclamation. On ne va pas accepter les réclamations notifiées à FontanaArte après 8 jours de la réception des Produits.
 - Aucune restitution de marchandise ne sera acceptée si elle n'a pas été préalablement autorisée par FontanaArte. La restitution des Produits ne devra être effectuée que par l'intermédiaire du transporteur officiel indiqué par FontanaArte qui sera préalablement, sans aucun crédit, autorisé à effectuer le retrait. Les Produits devront être restitués dans leur emballage d'origine. Dès la réception des Produits restitués, le service des retours clients de FontanaArte vérifiera les Produits. En cas de défaut de fabrication, le remplacement des Produits sera effectué gratuitement. Si le défaut constaté ne peut être considéré comme un vice de fabrication, le revendeur fera en sorte que les Produits restent disponibles pour le retrait pendant trente jours à compter de la date à laquelle le résultat de l'inspection aura été communiqué au revendeur. Passé ce délai, sans instructions du revendeur, ces produits seront détruits sans que le revendeur n'ait droit à quoi que ce soit en rapport avec ce qui précède.
 - Sauf en cas de faute intentionnelle ou de négligence grave et de toute autre responsabilité qui ne peut être exclue ou limitée en vertu des dispositions impératives de la loi, FontanaArte ne sera pas responsable envers le revendeur pour un montant supérieur au prix payé par le ce dernier en vertu de chaque contrat et / ou pour tout type de dommages indirects.
 - FontanaArte a le droit de suspendre la fourniture des Produits lorsque les conditions financières ou les actifs du revendeur sont de nature à mettre en danger la réalisation du paiement dû ou pour d'autres raisons de nature commerciale et de gestion de FontanaArte.
 - Le non-paiement ou le retard de paiement des sommes dues à FontanaArte par le revendeur selon les termes du Contrat entraînera l'application d'un intérêt de 3 % sur le montant de chaque facture des Produits achetés pour chaque mois de retard, à compter du jour indiqué dans le Contrat.
 - FontanaArte se réserve le droit de modifier l'une quelconque des clauses ci-dessus à sa seule discrétion et sans obligation de notification au revendeur, étant entendu que toute modification entrera en vigueur pour tous les Contrats conclus après notification transmise au revendeur par FontanaArte, éventuellement en publiant les Conditions mises à jour sur le site Internet de FontanaArte, de ladite modification.
 - Chaque Contrat est régi et interprété conformément à la loi de la République italienne.
 - Pour tout litige susceptible de survenir entre les parties en relation avec chaque Contrat, le Tribunal de Milan sera seul compétent.

RICHTLINIE ÜBER ELEKTRO- UND ELEKTRONIKALTGERÄTE

Altgeräten umgesetzt. Die Art und Weise, in der das Dekret den Herstellern von Elektro- und Elektronikgeräten die Möglichkeit bietet, die Rückgewinnung und Entsorgung von Abfällen aus solchen Geräten zu finanzieren, wird als Ökoabgabe bezeichnet, eine Modalität, die von allen Herstellern des Ecolight-Konsortiums, einschließlich FontanaArte, angewandt wird.

Die Öko-Abgabe WEEE ist im Verkaufspreis einbezogen.

Regelmäßige und gelegentliche Exporteure sind von der WEEE-Ökoabgabe befreit.

Registrierungsnummer für Elektro- und Elektronikgeräte: IT6120000009612 (AEE) / DE37033037 (EAR)

ALLGEMEINE VERKAUFSBEDINGUNGEN FÜR HÄNDLER

- Diese Allgemeinen Verkaufsbedingungen („Bedingungen“) ersetzen und annullieren alle früheren Ausgaben. Sie regeln die vertraglichen Beziehungen zwischen FontanaArte S.p.A. („FontanaArte“) und ihren jeweiligen Händlern, die die Lieferung von FontanaArte-Produkten („Produkte“) zum Gegenstand haben, wie sie von Mal zu Mal in der vom Händler – in jeglicher Form und egal mit welchen Mitteln – erteilten und von FontanaArte bestätigten Bestellung („Bestellung“) angegeben sind.
- Nachstehende, in der Preisliste angegebenen, von Zeit zu Zeit aktualisierten und auf der Website www.fontanaarte.com hochgeladenen Bedingungen – werden mit der Übermittlung in jeglicher Form und mit jedem Medium der Bestellung an FontanaArte vom Händler vollständig und automatisch akzeptiert. Mit der Übermittlung der Bestellung bestätigt der Händler daher, die Bedingungen zu kennen und zu akzeptieren. Andere Bedingungen, Fristen oder Prognosen des Händlers sind ausgeschlossen. Sollte der Händler mit einigen der in den Bedingungen enthaltenen Punkten nicht einverstanden sein, fordert FontanaArte den Einzelhändler auf, die Bestellung zum Kauf der Produkte nicht aufzugeben. Zum Zeitpunkt der Absendung einer Bestellung durch den Händler an FontanaArte liegt es in der Verantwortung und Sorgfalt des Händlers, den Inhalt der Bedingungen zu überprüfen, die von FontanaArte von Zeit zu Zeit aktualisiert und auf seiner oben genannten Website veröffentlicht werden.
- FontanaArte behält sich das Recht vor, jederzeit Produkte aus seinen Kollektionen oder Katalogen zu entfernen und Preisänderungen oder andere Änderungen vorzunehmen, die sich aus technischen oder kommerziellen Gründen ergeben. Besagte Änderungen gelten jedoch nicht für wie nachstehend definierte Verträge, die vor der Bekanntgabe der jeweiligen Änderung durch FontanaArte an den Händler abgeschlossen wurden.
- Die Lieferung erfolgt stets zu den in der Preisliste von FontanaArte angegebenen Preisen und zu den am Tag der Auftragsbestätigung gültigen Bedingungen. Sofern zwischen den Parteien nichts anderes vereinbart wird, werden auf den Wert der Listenpreise keine Ermäßigungen oder Rabatte gewährt.
- Die Erteilung einer Bestellung stellt ein vertragliches Angebot des Händlers an FontanaArte dar, die Produkte unter vorliegenden Bedingungen zu kaufen. Die Bestellung gilt nur dann als angenommen, wenn FontanaArte (a) eine schriftliche Auftragsbestätigung ausstellt oder (b) die Produkte in Übereinstimmung mit der Bestellung liefert, wobei diese Tatsache als stillschweigende Annahme betrachtet wird.
- Zeigt die von FontanaArte herausgegebene Auftragsbestätigung eine Änderung des Inhalts der jeweiligen Bestellung (einschließlich dieser Bedingungen) auf, so gilt die Auftragsbestätigung automatisch als neues Vertragsangebot von FontanaArte, das vom Händler akzeptiert werden muss. Stornierungen von bereits übermittelten und bestätigten Bestellungen werden nicht akzeptiert, es sei denn, es besteht eine schriftliche Vereinbarung zwischen den Parteien.
- Der Vertrag zwischen FontanaArte und dem Händler über die Lieferung der Produkte („Vertrag“ – der Vertrag setzt sich aus den Bedingungen und der von FontanaArte akzeptierten Bestellung oder durch das vom Händler akzeptierte Gegenangebot von FontanaArte zusammen) gilt in folgenden Fällen als abgeschlossen: (i) am Tag der schriftlichen Bestellsannahme durch FontanaArte; oder (ii) in dem Zeitpunkt, in dem die Ausführung begonnen hat (im Falle der stillschweigenden Annahme zu den oben genannten Bedingungen) und im Falle der Annahme des Gegenangebots durch den Händler.
- Der Händler ist verpflichtet, die Richtigkeit der Auftragsbestätigung und der darin

angegebenen Bedingungen, einschließlich der Verkaufs- und Zahlungsbedingungen, zu überprüfen.

- Die Produkte werden in der Weise und an den Ort geliefert, der in der bestätigten Bestellung angegeben ist („Lieferort“). Sofern zwischen den Parteien nichts anderes vereinbart ist, erfolgt die Lieferung der Produkte zu den nachstehenden Bedingungen an den Lieferort:
 - Frei Bestimmungsort für Bestellungen ab einem Wert von € 1.000,00;
 - mit 7 % mehr in der Rechnung bei Bestellwerten zwischen € 500 und € 1.000,00;
 - mit € 50,00 mehr in der Rechnung bei Bestellwerten bis € 500,00.

Die oben genannten Konditionen gelten für folgende Länder:

Italien, Frankreich, Spanien (Inseln nicht inbegriffen), Österreich, Schweiz, Deutschland, Belgien, Luxemburg, Niederland und Slowenien. Für andere Länder wenden Sie sich bitte an unseren Customer Service.

- Der Gefahrenübergang vom Lieferanten auf den Händler erfolgt ab dem Zeitpunkt, an dem die Produkte an den Lieferort geliefert werden. Von diesem Zeitpunkt an trägt der Händler das Risiko des Verfalls, des Verlustes oder der Beschädigung der Produkte.
- Der Händler kann die Produkte im Rahmen seiner normalen Geschäftstätigkeit an Endkunden weiterverkaufen. Es ist ihm verboten, die Produkte an Subjekte zu verkaufen, die sie zur Weiterveräußerung kaufen.
- Die Produkte FontanaArte haben 2 Jahre Garantie. Reklamationen im Zusammenhang mit fehlerhaften Produkten können akzeptiert werden, und das anschließende Verfahren zur Rückgabe und zum Austausch der Produkte oder ihrer fehlerhaften Teile kann nur gegen Vorlage einer Kopie des Steuerelements eingeleitet werden, das den jeweiligen Kauf bescheinigt, und verlangt das korrekte Ausfüllen des entsprechenden Reklamationsformulars. Beschwerden, die FontanaArte später als 8 Tage nach Erhalt der Produkte mitgeteilt werden, werden zurückgewiesen.
- Rücksendungen werden nur angenommen, wenn sie im Vorfeld von FontanaArte schriftlich genehmigt wurden. Die Rücksendung der Produkte darf nur über den von FontanaArte angegebenen offiziellen Spediteur erfolgen, der vorab, ohne jede Kostenanrechnung, zur Abholung ermächtigt werden wird. Die Produkte müssen in der Originalverpackung zurückgegeben werden. Nach Eintreffen der zurückgesandten Produkte wird die Abteilung für Kundenrücksendungen von FontanaArte die Produkte überprüfen. Im Falle von Herstellungsfehlern ist der Ersatz der Produkte kostenlos. Sollte der festgestellte Fehler nicht als Herstellungsfehler angesehen werden können, stehen die Produkte dem Händler ab dem Datum, 30 Tage lang zur Abholung zur Verfügung, an dem das Prüfungsergebnis dem Händler mitgeteilt wurde. Nach Ablauf dieser Frist ohne Weisung des Händlers werden diese Produkte vernichtet, ohne dass der Händler im Zusammenhang mit dem Vorstehenden Anspruch auf etwas hat.
- Außer bei Vorsatz oder grober Fahrlässigkeit und jeder anderen Haftung, die nach den zwingenden gesetzlichen Bestimmungen nicht ausgeschlossen oder beschränkt werden kann, haftet FontanaArte gegenüber dem Händler nicht für einen Betrag, der über dem vom Händler vertraglich vereinbarten Preis liegt, und/oder für indirekte Schäden jeglicher Art.
- FontanaArte ist berechtigt, die Lieferung von Produkten auszusetzen, wenn die Finanz- oder Vermögensbedingungen des Händlers fällige Zahlungen eindeutig gefährden oder wenn andere Gründe kommerzieller und verwaltungsspezifischer Art von FontanaArte gegeben sind.
- Bei Zahlungsausstand oder -verzug des Händlers gegenüber FontanaArte innerhalb der vertraglich vorgesehenen Fristen werden pro Monat Verspätung ab der im Vertrag angegebenen Frist 3 % Zinsen auf den jeweiligen Rechnungsbetrag für die gekauften Produkte erhoben.
- FontanaArte behält sich das Recht vor, jede der vorstehenden Klauseln nach eigenem Ermessen und ohne Verpflichtung zur Benachrichtigung des Händlers zu ändern, wobei jede Änderung erst in Kraft tritt, wenn sie sich auf einen Vertrag bezieht, der nach Mitteilung der Änderung vonseiten FontanaArte an den Händler abgeschlossen wurde, eventuell durch Veröffentlichung der aktualisierten Bedingungen auf der Website von FontanaArte.
- Jeder Vertrag unterliegt dem Recht der Italienischen Republik und wird in Übereinstimmung mit diesem ausgelegt.
- Für alle Streitfälle, die zwischen den Parteien in Bezug auf jeden Vertrag entstehen können, ist ausschließlicher Gerichtsstand das Gericht von Mailand.

DIRECTIVA SOBRE RESIDUOS DE APARATOS ELÉCTRICOS Y ELECTRÓNICOS (RAEE)

El 14 de marzo de 2014, el Consejo de Ministros de la República Italiana traspuso la nueva Directiva Europea EU 2012/19/UE en materia de recogida y eliminación de residuos de aparatos eléctricos y electrónicos por medio del Decreto Legislativo N° 49/2014. Las modalidades, con que el Decreto puso a disposición de los fabricantes de aparatos eléctricos y electrónicos la posibilidad de financiar las actividades de recogida y eliminación de los residuos de dichos aparatos, se denominan eco-contribución. A dicha modalidad se acogen todos los fabricantes que forman parte del consorcio Ecolight, entre los cuales figura FontanaArte.

La eco-contribución RAEE está incluida en el precio de venta.

Los exportadores, habituales y ocasionales, se eximen de pagar la eco-contribución RAEE.

Número de inscripción en el Registro de Aparatos Eléctricos y Electrónicos:
IT6120000009612 (AEE) / DE37033037 (EAR)

CONDICIONES GENERALES DE VENTA PARA EL REVENDEDOR

- Les présentes conditions générales de vente (« Conditions ») remplacent et annulent les éditions précédentes ; elles régissent les relations contractuelles établies entre la société FontanaArte S.p.A. (« FontanaArte ») et ses revendeurs, ayant pour objet la fourniture de produits FontanaArte (« Produits »), comme indiqué au cas par cas dans le bon de commande (« Commande ») émis - sous n'importe quelle forme et avec tout moyen quel qu'il soit - par le revendeur.
- Les suivantes Conditions – indiquées sur le catalogue de prix, mises à jour au cas par cas et insérées sur le site Internet www.fontanaarte.com sont acceptées intégralement et automatiquement par le revendeur dès que ce dernier transmet, sous n'importe quelle forme et sur tout support quel qu'il soit, une Commande à FontanaArte. En transmettant une Commande, le revendeur confirme donc qu'il connaît les conditions et qu'il les accepte. L'application de tout autre terme, condition ou prévision du revendeur est exclue. Au cas où le revendeur ne serait pas d'accord avec certains termes indiqués dans les Conditions, FontanaArte invitera ledit revendeur à ne pas envoyer de Commande d'achat de Produits. Au moment où le revendeur enverra toute Commande quelle qu'elle soit à FontanaArte, il sera tenu de vérifier le contenu des Conditions mises à jour au cas par cas par la société FontanaArte et publiées par cette dernière sur le site Web mentionné ci-dessus.
- FontanaArte se réserve le droit, à tout moment, de retirer des produits de ses collections ou catalogues et d'effectuer des changements de prix ou d'autres modifications résultant de besoins techniques ou commerciaux. Ces modifications ne s'appliqueront pas aux Contrats, tels que définis ci-dessous, déjà conclus avant la notification de la modification par FontanaArte au revendeur.
- La livraison s'effectue toujours aux prix indiqués dans le tarif FontanaArte et selon les conditions en vigueur à la date de la confirmation de la Commande. Sauf accord contraire convenu entre les parties, aucune réduction ou rabais n'est accordé sur la valeur des prix du catalogue.
- L'émission de toute commande constitue une proposition contractuelle, transmise à FontanaArte par le revendeur, d'acheter les Produits conformément aux présentes Conditions. La Commande n'est considérée comme acceptée que si FontanaArte (a) délivre une confirmation de Commande écrite ou (b) procède à la fourniture des Produits, conformément à la Commande, considérant ce fait comme une acceptation tacite.
- Si la confirmation de Commande émise par FontanaArte fait apparaître une modification du contenu de la Commande concernée (y compris les présentes Conditions), la confirmation de Commande sera automatiquement considérée comme une nouvelle proposition contractuelle, formulée par FontanaArte, qui devra être acceptée par le revendeur. Les annulations de commandes déjà envoyées et confirmées ne seront pas acceptées sauf accord écrit entre les parties.
- Le contrat entre FontanaArte et le revendeur pour la fourniture des Produits (« Contrat ») - le Contrat se compose des Conditions et de la Commande acceptée par FontanaArte ou de la contre-proposition de FontanaArte acceptée par le revendeur) est réputé conclu (i) à la date de l'acceptation écrite de la Commande par FontanaArte; ou (ii) au moment où l'exécution commence (en cas d'acceptation tacite

aux conditions énoncées ci-dessus) et en cas d'acceptation de la contre-proposition de la part du revendeur.

- Le revendeur est tenu de vérifier l'exactitude de la confirmation de Commande et des Conditions, y compris les conditions de vente et de paiement, qui y sont indiquées.
- Les Produits seront livrés de la manière et au lieu indiqués dans la Commande confirmée (« Lieu de livraison »). Sauf accord contraire entre les parties, la livraison des Produits est effectuée au Lieu de livraison selon les conditions définies ci-après :
 - Franco destination pour les commandes d'une valeur supérieure à 1.000,00 € ;
 - Frais de 7% sur la valeur imposable de 500 € à 1.000,00 € ;
 - Majoration de la facturation de 50,00 € pour les commandes les achetant dans le but de les revendre. Les produits FontanaArte sont garantis deux ans. Les réclamations relatives aux Produits défectueux ne pourront être acceptées et la procédure de retour et de remplacement des Produits ou de leurs pièces défectueuses ne pourra activée que sur présentation d'une copie du document fiscal attestant l'achat, et en remplissant correctement le formulaire de réclamation correspondant. FontanaArte n'acceptera pas les réclamations qui lui seront notifiées plus de huit jours à compter de la réception des produits.
- Aucune restitution de marchandise ne sera acceptée si elle n'a pas été préalablement autorisée par FontanaArte. La restitution des Produits ne devra être effectuée que par l'intermédiaire du transporteur officiel indiqué par FontanaArte qui sera préalablement, sans aucun crédit, autorisé à effectuer le retrait. Les Produits devront être restitués dans leur emballage d'origine. Dès la réception des Produits restitués, le service des retours clients de FontanaArte vérifiera les Produits. En cas de défaut de fabrication, le remplacement des Produits sera effectué gratuitement. Si le défaut constaté ne peut être considéré comme un vice de fabrication, le revendeur fera en sorte que les Produits restent disponibles pour le retrait pendant trente jours à compter de la date à laquelle le résultat de l'inspection aura été communiqué au revendeur. Passé ce délai, sans instructions du revendeur, ces produits seront détruits sans que le revendeur n'ait droit à quoi que ce soit en rapport avec ce qui précède.
- Sauf en cas de faute intentionnelle ou de négligence grave et de toute autre responsabilité qui ne peut être exclue ou limitée en vertu des dispositions impératives de la loi, FontanaArte ne sera pas responsable envers le revendeur pour un montant supérieur au prix payé par le ce dernier en vertu de chaque contrat et / ou pour tout type de dommages indirects.
- FontanaArte a le droit de suspendre la fourniture des Produits lorsque les conditions financières ou les actifs du revendeur sont de nature à mettre en danger la réalisation du paiement dû ou pour d'autres raisons de nature commerciale et de gestion de FontanaArte.
- Le non-paiement ou le retard de paiement des sommes dues à FontanaArte par le revendeur selon les termes du Contrat entraînera l'application d'un intérêt de 3 % sur le montant de chaque facture des Produits achetés pour chaque mois de retard, à compter du jour indiqué dans le Contrat.
- FontanaArte se réserve le droit de modifier l'une quelconque des clauses ci-dessus à sa seule discrétion et sans obligation de notification au revendeur, étant entendu que toute modification entrera en vigueur pour tous les Contrats conclus après notification transmise au revendeur par FontanaArte, éventuellement en publiant les Conditions mises à jour sur le site Internet de FontanaArte, de ladite modification.
- Chaque Contrat est régi et interprété conformément à la loi de la République italienne.
- Pour tout litige susceptible de survenir entre les parties en relation avec chaque Contrat, le Tribunal de Milan sera seul compétent.

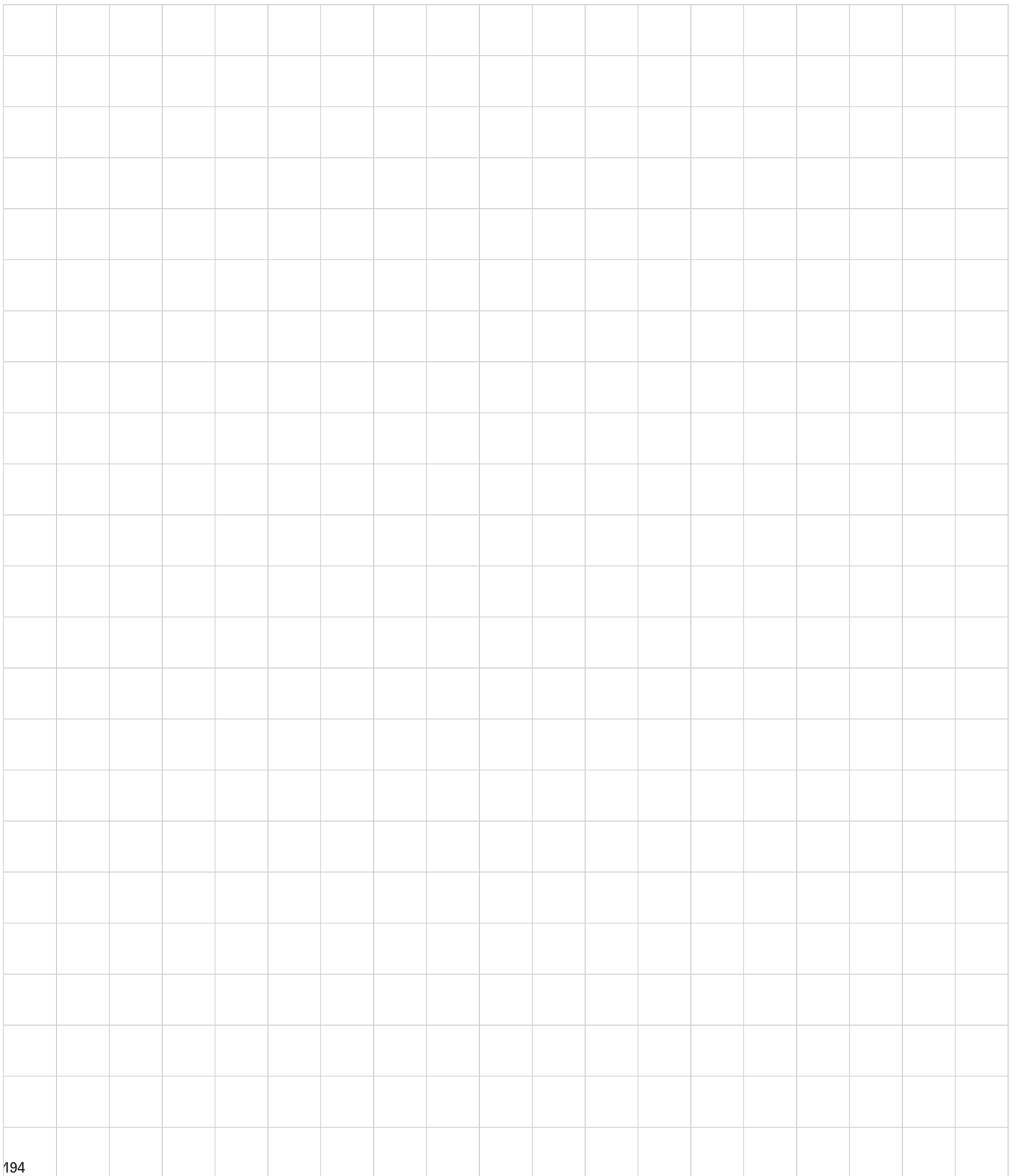

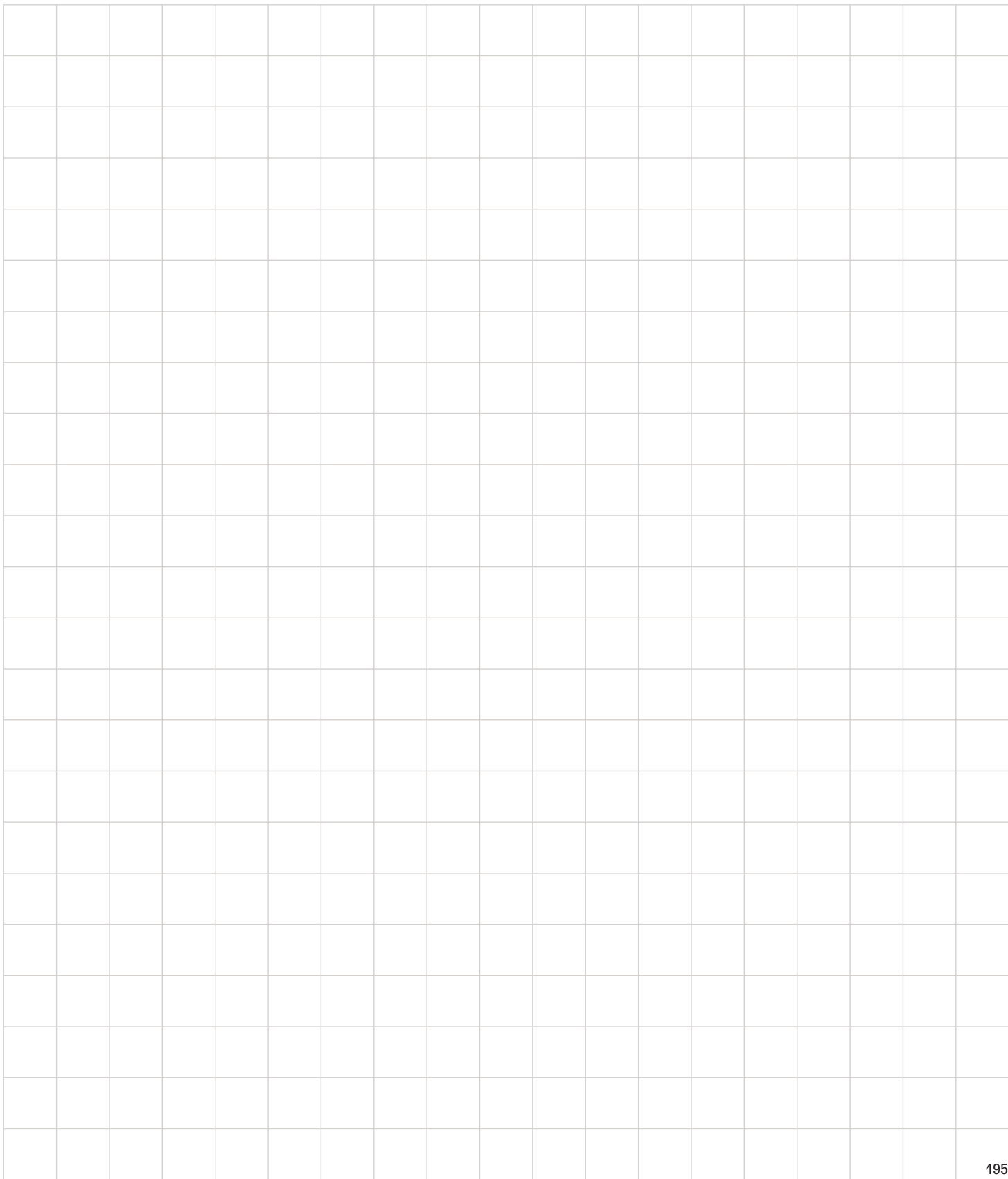

SEDE / HEADQUARTERS

FONTANAARTE SPA

Alzaia Trieste 49
I-20094 Corsico (MI)
Ph. +39 02 45121
Fax +39 02 4512660 / 990
info@fontanaarte.com
P.I.: 09632850963

ICGROUP US CORP

152 Madison Ave, Suite # 1002
New York, NY 10016, USA
Ph. +1 (212) 334 3295

www.fontanaarte.com
Instagram: fontanaarte

FontanaArte è azienda certificata
ISO 9001:2015 con DNV - GL. Certificato
nr. 178796-2015-AQ-ITA-ACCREDIA

FontanaArte has ISO 9001:2015
certification from the DNV - GL. Certificate
no. 178796-2015-AQ-ITA-ACCREDIA

1998
ADI Compasso d'Oro
Career Award



FontanaArte sostiene
FontanaArte supports



Membro di
Member of



Dal 1992 Fondazione Altagamma
riunisce i marchi dell'eccellenza italiana
famosi a livello internazionale.
Since 1992 the Altagamma Foundation
has gathered together high-end Italian
brands famous at international level.