

2023

deutsch
international



LIVING THE LIGHT

serien
.lighting

Ceiling	ANNEX	4
	CAVITY	6
	CURLING	8
	DRAFT	12
	DRUM <small>new</small>	14
	POPPY	16
	REEF	11
	REFLEX²	19
	SLICE² PI <small>new</small>	24
Suspension	ANNEX	58
	CAVITY	60
	CURLING	62
	DRAFT	66
	DRUM <small>new</small>	68
	ONE EIGHTY	70
	POPPY	72
	PROPELLER	73
	REEF	74
	TWIN	75
	ZOOM	76
	ZOOM XL	76
	Wall	APP
CAVITY <small>new</small>		105
CLUB		106
CRIB		107
CURLING		108
LID		110
POPPY		112
REEF		115
REFLEX² <small>new</small>		116
ROD		117
SML		118
SML²		120
Table		JOB
	POPPY	156
	REFLEX² <small>new</small>	157
	SLICE²	158
Floor	CENTRAL	168
	CLUB	169
	JONES	171
	POPPY	172
	REFLEX² <small>new</small>	174
	SLICE²	176
Accessories	Baldachinprofile / Canopy profiles	198
	Ersatzbezug / Replacement cover	200
	Kristallglas Anhänger / Crystal glas pendant	200
	Optiken / Optics <small>new</small>	201
	Spiegel Adapter Set / Mirror adapter set	201
	Wandadapter / Wall adapters	202
	Wandabdeckungen / Wall cover	203

Info	Information	205
	Awards	206
	Contacts	207
	Imprint	208



ANNEX
S. 4



CAVITY
S. 6

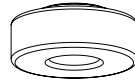

CURLING
S. 8

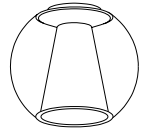

DRAFT
S. 12

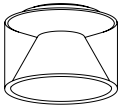

DRUM
S. 14
new

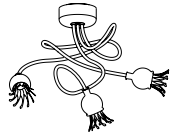

POPPY
S. 16



REEF
S. 11

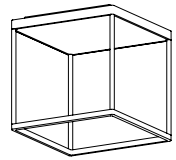

REFLEX²
S. 19



SLICE² PI
S. 24
new

ANNEX Ceiling

Eine geradezu archetypische Deckenleuchte mit dem Mehr an Funktionalität, auf das wir Wert legen: drei verschiedene Größen korrespondieren mit den Proportionen Ihrer Räume. Mit den unterschiedlichen Reflektoren im Innern des mundgeblasenen Kegelschirms lassen sich äußerst differenzierte Lichtwirkungen erzielen, die formal dennoch einer Familie angehören.

A quite archetypal ceiling lamp with that added functionality we value: three different sizes correspond with the proportions of your rooms. The different reflectors on the inside of the hand-blown spherical shade enable extremely varied light effects, which nonetheless formally are part of one family.

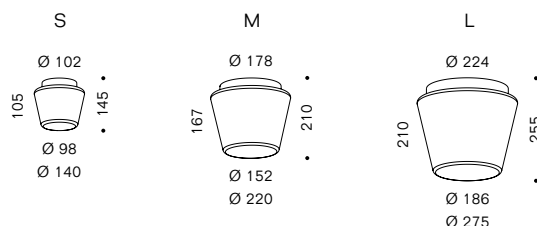

Leuchtmittel LED 9–41 W, CoB, CRI Ra>97 (R9>80), EEK/EEC E (3000 K), F (2700 K)
lamp S: G9, M: B15d, L: E27, EEK/EEC G (M, L: Lieferung ohne Leuchtmittel/delivery without bulb)

Leuchteneinheit Aluminium, hochglanzpoliert und weiß beschichtet
lighting unit aluminum, highly polished coated white

Schirm mundgeblasenes Glas klar
shade hand-blown glass clear

Ausführungen
versions



Glasschirm klar, Reflektor Acrylglas opal
Licht: nach unten gerichtet, rundum gestreut
 glass shade clear, reflector acrylic glass opal
 light: directed downwards, distributed all around





Glasschirm klar, Reflektor Aluminium poliert
Licht: nach unten gerichtet, rundum diffus
 glass shade clear, reflector: aluminium polished
 light: directed downwards, diffused all around





Glasschirm klar, Reflektor Kristallglas geschliffen mit Aluminium-Innenreflektor
Licht: nach unten gerichtet, rundum dekorativ
 glass shade clear, reflector crystal glass with aluminium reflector
 light: directed downwards, diffused all around

Sonstiges LED austauschbar; werkzeuglose Schirmmontage; 110 V-Varianten auf Anfrage
features LED exchangeable; glass shade tool-free mountable; 110 V versions on request



ANNEX Ceiling S

Abbildung figure	Beschreibung description	Leuchtmittel lamp	Regelung control	Leistung power	CCT	Lumen lumen	Art.-Nr. art.-no.	€ netto DE excl. VAT	€ brutto DE incl. VAT
	Reflektor opal reflector opal	LED	TRIAC	9 W	2700 K	1020 lm	AN3201	336,13 €	400,00 €
					3000 K	1060 lm	AN3202	336,13 €	400,00 €
		G9	TRIAC	max. 60 W	2700 K	980 lm	AN1013	260,50 €	310,00 €
	Reflektor poliert reflector polished	LED	TRIAC	9 W	2700 K	1020 lm	AN3211	361,34 €	430,00 €
					3000 K	1060 lm	AN3212	361,34 €	430,00 €
		G9	TRIAC	max. 60 W	2700 K	980 lm	AN1121	281,51 €	335,00 €
	Reflektor Kristall reflector crystal	LED	TRIAC	9 W	2700 K	1020 lm	AN3221	428,57 €	510,00 €
					3000 K	1060 lm	AN3222	428,57 €	510,00 €
		G9	TRIAC	max. 60 W	2700 K	980 lm	AN1043	352,94 €	420,00 €

ANNEX Ceiling M

Abbildung figure	Beschreibung description	Leuchtmittel lamp	Regelung control	Leistung power	CCT	Lumen lumen	Art.-Nr. art.-no.	€ netto DE excl. VAT	€ brutto DE incl. VAT
	Reflektor opal reflector opal	LED	TRIAC	20 W	2700 K	1450 lm	AN3001	457,98 €	545,00 €
					3000 K	1500 lm	AN3002	457,98 €	545,00 €
			DALI	27 W	2700 K	2900 lm	AN3006	491,60 €	585,00 €
					3000 K	3000 lm	AN3007	491,60 €	585,00 €
B15d	TRIAC	max. 100 W	2800 K	1800 lm	AN1066	336,13 €	400,00 €		
	Reflektor poliert reflector polished	LED	TRIAC	20 W	2700 K	1450 lm	AN3011	491,60 €	585,00 €
					3000 K	1500 lm	AN3012	491,60 €	585,00 €
			DALI	27 W	2700 K	2900 lm	AN3015	525,21 €	625,00 €
					3000 K	3000 lm	AN3016	525,21 €	625,00 €
B15d	TRIAC	max. 100 W	2800 K	1800 lm	AN1078	369,75 €	440,00 €		
	Reflektor Kristall reflector crystal	LED	TRIAC	20 W	2700 K	1450 lm	AN3021	596,64 €	710,00 €
					3000 K	1500 lm	AN3022	596,64 €	710,00 €
			DALI	27 W	2700 K	2900 lm	AN3025	630,25 €	750,00 €
					3000 K	3000 lm	AN3026	630,25 €	750,00 €
B15d	TRIAC	max. 100 W	2800 K	1800 lm	AN1073	474,79 €	565,00 €		

ANNEX Ceiling L

Abbildung figure	Beschreibung description	Leuchtmittel lamp	Regelung control	Leistung power	CCT	Lumen lumen	Art.-Nr. art.-no.	€ netto DE excl. VAT	€ brutto DE incl. VAT
	Reflektor opal reflector opal	LED	TRIAC	34 W	2700 K	3850 lm	AN3047	529,41 €	630,00 €
					3000 K	4010 lm	AN3048	529,41 €	630,00 €
			DALI	41 W	2700 K	4500 lm	AN3051	571,43 €	680,00 €
					3000 K	4680 lm	AN3052	571,43 €	680,00 €
E27	TRIAC	max. 150 W	2900 K	2870 lm	AN1067	424,37 €	505,00 €		
	Reflektor poliert reflector polished	LED	TRIAC	34 W	2700 K	3850 lm	AN3053	571,43 €	680,00 €
					3000 K	4010 lm	AN3054	571,43 €	680,00 €
			DALI	41 W	2700 K	4500 lm	AN3057	613,45 €	730,00 €
					3000 K	4680 lm	AN3058	613,45 €	730,00 €
E27	TRIAC	max. 150 W	2900 K	2870 lm	AN1079	470,59 €	560,00 €		
	Reflektor Kristall reflector crystal	LED	TRIAC	34 W	2700 K	3850 lm	AN3041	731,09 €	870,00 €
					3000 K	4010 lm	AN3042	731,09 €	870,00 €
			DALI	41 W	2700 K	4500 lm	AN3045	773,11 €	920,00 €
					3000 K	4680 lm	AN3046	773,11 €	920,00 €
E27	TRIAC	max. 150 W	2900 K	2870 lm	AN1074	613,45 €	730,00 €		

CAVITY Ceiling & Recessed

Ein speziell konzipierter, kurvenförmiger Aluminiumkörper mit vertieft sitzendem Leuchtmittel ersetzt beim Strahler CAVITY den Reflektor und erlaubt eine freie Entfaltung des Lichts, das über die Trichterform scheinbar nach außen fließt. Es entsteht ein Downlight mit einem blendfreien und sanften Licht, das aus jedem Winkel angenehm wirkt. Unterschiedliche Beleuchtungsaufgaben können einheitlich durch Kombination von Aufbau- und Einbaustrahlern mit den Pendelleuchten sowie den Wandleuchten dieser Produktfamilie gelöst werden.



A specially designed, curved aluminum body including the recessed illuminant replaces the reflector in spotlight CAVITY and allows the light to unfold freely, seemingly flowing outwards via the funnel shaped form. The result is a glare-free and soft downlight, that is pleasant from all angles. Different lighting tasks can be solved consistently by combining the surface-mounted and recessed spotlights with the pendant luminaires and wall luminaires of this product family.

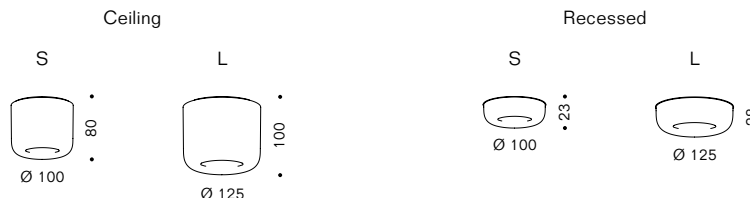

Licht
light **nach unten gerichtet, seitlich abgeschirmt**
directed downwards, shielded to the sides

Leuchtmittel
lamp LED 10–20 W, CoB, CRI Ra>95 (R9>80), EEK/EEC F

Gehäuse
housing **Aluminium schwarz oder weiß beschichtet, Aluminiumglanz finish oder Bronze finish**
aluminum black or white coated, aluminum gloss finish or bronze finish

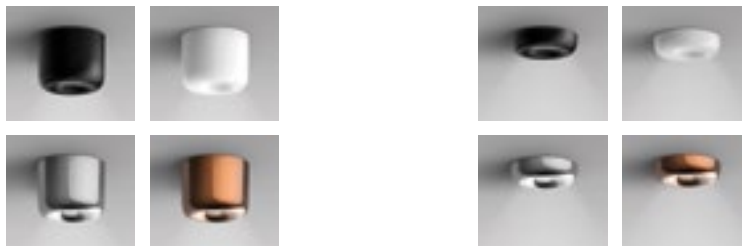

Sonstiges
features **LED wechselbar, werkzeuglose Gehäusemontage; Recessed Varianten benötigen eine Bauraumhöhe oberhalb der Deckenunterkante von: S/L TRIAC >45 mm, S DALI >85 mm, L DALI >65 mm; 110 V-Varianten auf Anfrage**
LED exchangeable, housing tool-free mountable; recessed variants require an installation space above the lower edge of the ceiling of: S/L TRIAC >45 mm, S DALI >85 mm, L DALI >65 mm; 110 versions on request

CAVITY Ceiling S

Abbildung figure	Beschreibung description	Leuchtmittel lamp	Regelung control	Leistung power	CCT	Lumen lumen	Art.-Nr. art.-no.	€ netto DE excl. VAT	€ brutto DE incl. VAT
●	schwarz black	LED	TRIAC	12 W	2700 K	1220 lm	CA1001	184,87 €	220,00 €
					3000 K	1280 lm	CA1002	184,87 €	220,00 €
○	weiß white	LED	TRIAC	12 W	2700 K	1220 lm	CA1003	184,87 €	220,00 €
					3000 K	1280 lm	CA1004	184,87 €	220,00 €
●	Aluminiumglanz finish aluminum gloss finish	LED	TRIAC	12 W	2700 K	1220 lm	CA1005	214,29 €	255,00 €
					3000 K	1280 lm	CA1006	214,29 €	255,00 €
●	Bronze finish bronze finish	LED	TRIAC	12 W	2700 K	1220 lm	CA1007	214,29 €	255,00 €
					3000 K	1280 lm	CA1008	214,29 €	255,00 €

CAVITY Ceiling L

Abbildung figure	Beschreibung description	Leuchtmittel lamp	Regelung control	Leistung power	CCT	Lumen lumen	Art.-Nr. art.-no.	€ netto DE excl. VAT	€ brutto DE incl. VAT
●	schwarz black	LED	TRIAC	20 W	2700 K	2070 lm	CA2001	239,50 €	285,00 €
					3000 K	2140 lm	CA2002	239,50 €	285,00 €
			DALI	20 W	2700 K	2070 lm	CA2005	289,92 €	345,00 €
					3000 K	2140 lm	CA2006	289,92 €	345,00 €
○	weiß white	LED	TRIAC	20 W	2700 K	2070 lm	CA2007	239,50 €	285,00 €
					3000 K	2140 lm	CA2008	239,50 €	285,00 €
			DALI	20 W	2700 K	2070 lm	CA2011	289,92 €	345,00 €
					3000 K	2140 lm	CA2012	289,92 €	345,00 €
●	Aluminiumglanz finish aluminum gloss finish	LED	TRIAC	20 W	2700 K	2070 lm	CA2013	277,31 €	330,00 €
					3000 K	2140 lm	CA2014	277,31 €	330,00 €
			DALI	20 W	2700 K	2070 lm	CA2017	327,73 €	390,00 €
					3000 K	2140 lm	CA2018	327,73 €	390,00 €
●	Bronze finish bronze finish	LED	TRIAC	20 W	2700 K	2070 lm	CA2019	277,31 €	330,00 €
					3000 K	2140 lm	CA2020	277,31 €	330,00 €
			DALI	20 W	2700 K	2070 lm	CA2023	327,73 €	390,00 €
					3000 K	2140 lm	CA2024	327,73 €	390,00 €

CAVITY Recessed S

Abbildung figure	Beschreibung description	Leuchtmittel lamp	Regelung control	Leistung power	CCT	Lumen lumen	Art.-Nr. art.-no.	€ netto DE excl. VAT	€ brutto DE incl. VAT
●	schwarz black	LED	TRIAC	10 W	2700 K	1220 lm	CA1301	172,27 €	205,00 €
					3000 K	1280 lm	CA1302	172,27 €	205,00 €
○	weiß white	LED	TRIAC	10 W	2700 K	1220 lm	CA1303	172,27 €	205,00 €
					3000 K	1280 lm	CA1304	172,27 €	205,00 €
●	Aluminiumglanz finish aluminum gloss finish	LED	TRIAC	10 W	2700 K	1220 lm	CA1305	197,48 €	235,00 €
					3000 K	1280 lm	CA1306	197,48 €	235,00 €
●	Bronze finish bronze finish	LED	TRIAC	10 W	2700 K	1220 lm	CA1307	197,48 €	235,00 €
					3000 K	1280 lm	CA1308	197,48 €	235,00 €

CAVITY Recessed L

Abbildung figure	Beschreibung description	Leuchtmittel lamp	Regelung control	Leistung power	CCT	Lumen lumen	Art.-Nr. art.-no.	€ netto DE excl. VAT	€ brutto DE incl. VAT
●	schwarz black	LED	TRIAC	20 W	2700 K	2070 lm	CA2301	226,89 €	270,00 €
					3000 K	2140 lm	CA2302	226,89 €	270,00 €
			DALI	20 W	2700 K	2070 lm	CA2305	277,31 €	330,00 €
					3000 K	2140 lm	CA2306	277,31 €	330,00 €
○	weiß white	LED	TRIAC	20 W	2700 K	2070 lm	CA2307	226,89 €	270,00 €
					3000 K	2140 lm	CA2308	226,89 €	270,00 €
			DALI	20 W	2700 K	2070 lm	CA2311	277,31 €	330,00 €
					3000 K	2140 lm	CA2312	277,31 €	330,00 €
●	Aluminiumglanz finish aluminum gloss finish	LED	TRIAC	20 W	2700 K	2070 lm	CA2313	264,71 €	315,00 €
					3000 K	2140 lm	CA2314	264,71 €	315,00 €
			DALI	20 W	2700 K	2070 lm	CA2317	315,13 €	375,00 €
					3000 K	2140 lm	CA2318	315,13 €	375,00 €
●	Bronze finish bronze finish	LED	TRIAC	20 W	2700 K	2070 lm	CA2319	264,71 €	315,00 €
					3000 K	2140 lm	CA2320	264,71 €	315,00 €
			DALI	20 W	2700 K	2070 lm	CA2323	315,13 €	375,00 €
					3000 K	2140 lm	CA2324	315,13 €	375,00 €

CURLING Ceiling

Klare Formen und intelligente Gestaltungsdetails machen CURLING Ceiling zum universell einsetzbaren Downlight und Deckenlicht in einem. Das ermöglicht in jeder Raumsituation eine perfekte Lichtstimmung. CURLING Ceiling kombiniert nach unten gerichtetes Direktlicht mit sanft abstrahlendem Raumlicht. Versionen mit Acrylglasschirm in kantiger Ästhetik erweitern das Einsatzspektrum von CURLING und ermöglichen einen optimalen Einsatz in Schulen, Kindergärten, Treppenhäusern und anderen Verkehrswegen im halböffentlichen oder öffentlichen Raum.



With its clear shape and intelligent design CURLING Ceiling is an all-round downlight and ceiling light rolled into one. This allows the creation of a perfect lighting mood in any room situation. CURLING Ceiling combines light directed downward with softly diffusing ambient light. Versions with acrylic glass shade in angular aesthetics expand CURLING's range of applications and enable optimal use in schools, kindergartens, stairwells and other paths in semi-public and public spaces.

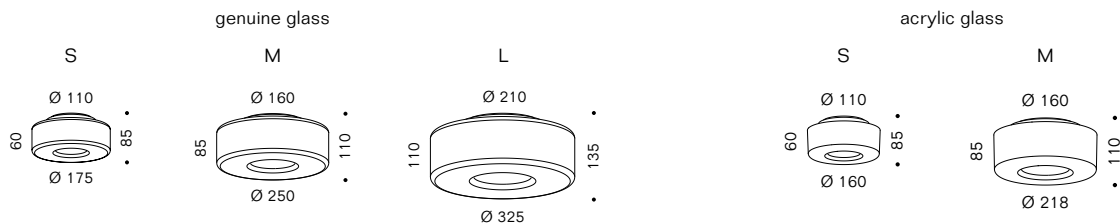

Leuchtmittel lamp LED 11–34 W, CoB, CRI Ra>97 (R9>80), EEK/EEC F (2700 K, 3000 K), G (1800–3000 K D2W)

Leuchteneinheit lighting unit Aluminium hochglanzpoliert
aluminum highly polished

Schirm shade mundgeblasenes Glas klar, opal oder metallisiert
Reflektor: Polycarbonat opal
hand-blown glass clear, opal or metallised
reflector: polycarbonate opal

Acrylglas klar
Reflektor: Polycarbonat opal
Acrylic glass clear
reflector: polycarbonate opal

Ausführungen versions



Glasschirm klar
Licht: nach unten gerichtet, rundum abstrahlend
glass shade clear
light: directed downwards, distributed all around



Acrylglaschirm klar
Licht: nach unten gerichtet, rundum abstrahlend
acrylic glass shade clear
light: directed downwards, distributed all around



Glasschirm klar, Reflektor konisch
Licht: nach unten gerichtet, rundum weich gestreut
glass shade clear, reflector conical
light: directed downwards, diffused all around



Acrylglaschirm klar, Reflektor konisch
Licht: nach unten gerichtet, rundum weich gestreut
acrylic glass shade clear, reflector conical
light: directed downwards, diffused all around



Glasschirm klar, Reflektor zylindrisch
Licht: nach unten gerichtet, rundum weich gestreut
glass shade clear, reflector cylindrical
light: directed downwards, diffused all around



Acrylglaschirm klar, Reflektor zylindrisch
Licht: nach unten gerichtet, rundum weich gestreut
acrylic glass shade clear, reflector cylindrical
light: directed downwards, diffused all around



Glasschirm opal
Licht: nach unten gerichtet, rundum weich gestreut
glass shade opal
light: directed downwards, diffused all around











Glasschirm neusilber
Licht: nach unten gerichtet, rundum abstrahlend
glass shade new silver
light: directed downwards, distributed all around

Sonstiges features LED wechselbar, werkzeuglose Schirmmontage; 110 V-Varianten auf Anfrage; Diffusorscheibe in Lieferung enthalten; DALI-Varianten für den Einsatz in Notbeleuchtungsanlagen auf Anfrage
LED exchangeable, shade tool-free mountable; 110 V versions on request; diffuser included in delivery; DALI versions for the use in emergency lighting systems on request









CURLING ist ein modularer Artikel. Bitte jeweils Leuchteneinheit und Glasschirm zusammen bestellen.
CURLING is a modular article. Please order the lighting unit and glass shade together.

☞ → 34–39 CURLING Suspension → 62 | CURLING Wall → 108

CURLING Ceiling S

Abbildung figure	Beschreibung description	Leuchtmittel lamp	Regelung control	Leistung power	CCT	Lumen lumen	Art.-Nr. art.-no.	€ netto DE excl. VAT	€ brutto DE incl. VAT		
	Leuchteneinheit S lighting unit S	LED	TRIAC	11 W	2700 K	1130 lm	LE015701	180,67 €	215,00 €		
					3000 K	1180 lm	LE015702	180,67 €	215,00 €		
					1800–3000 K D2W	870 lm	LE015703	214,29 €	255,00 €		
					DALI	11 W	2700 K	1130 lm	LE015730	205,88 €	245,00 €
							3000 K	1180 lm	LE015731	205,88 €	245,00 €
							1800–3000 K D2W	870 lm	LE015732	239,50 €	285,00 €
	Glas S klar glass S clear					CU014406	180,67 €	215,00 €			
	Glas S klar, Reflektor konisch glass S clear, reflector conical					CU014407	201,68 €	240,00 €			
	Glas S klar, Reflektor zylindrisch glass S clear, reflector cylindrical					CU014408	201,68 €	240,00 €			
	Glas S opal glass S opal					CU014405	172,27 €	205,00 €			
	Glas S neusilber glass S new silver					CU011201	243,70 €	290,00 €			
	Acrylglas S klar acrylic glass S clear					CU011203	75,63 €	90,00 €			
	Acrylglas S klar, Reflektor konisch acrylic glass S clear, reflector conical					CU011204	92,44 €	110,00 €			
	Acrylglas S klar, Reflektor zylindrisch acrylic glass S clear, reflector cylindrical					CU011205	92,44 €	110,00 €			





CURLING Ceiling M

Abbildung figure	Beschreibung description	Leuchtmittel lamp	Regelung control	Leistung power	CCT	Lumen lumen	Art.-Nr. art.-no.	€ netto DE excl. VAT	€ brutto DE incl. VAT		
	Leuchteneinheit M lighting unit M	LED	TRIAC	20 W	2700 K	1910 lm	LE015710	239,50 €	285,00 €		
					3000 K	2010 lm	LE015711	239,50 €	285,00 €		
					1800–3000 K D2W	1540 lm	LE015712	273,11 €	325,00 €		
					DALI 1–10 V	20 W	2700 K	1910 lm	LE015713	264,71 €	315,00 €
							3000 K	2010 lm	LE015714	264,71 €	315,00 €
							1800–3000 K D2W	1540 lm	LE015715	298,32 €	355,00 €
	Glas M klar glass M clear					CU014402	226,89 €	270,00 €			
	Glas M klar, Reflektor konisch glass M clear, reflector conical					CU014403	252,10 €	300,00 €			
	Glas M klar, Reflektor zylindrisch glass M clear, reflector cylindrical					CU014404	252,10 €	300,00 €			
	Glas M opal glass M opal					CU014401	214,29 €	255,00 €			
	Glas M neusilber glass M new silver					CU011202	306,72 €	365,00 €			
	Acrylglas M klar acrylic glass M clear					CU011206	100,84 €	120,00 €			
	Acrylglas M klar, Reflektor konisch acrylic glass M clear, reflector conical					CU011207	126,05 €	150,00 €			
	Acrylglas M klar, Reflektor zylindrisch acrylic glass M clear, reflector cylindrical					CU011208	126,05 €	150,00 €			

CURLING Ceiling M – Zubehör / Accessories

Optiken Einfach austauschbare Optiken zur Bestimmung der Lichtverteilung von CURLING Ceiling M finden Sie auf Seite 201.
optics Easily replaceable optics to define the light distribution of CURLING Wall M, see page 201.

CURLING Ceiling L

Abbildung figure	Beschreibung description	Leuchtmittel lamp	Regelung control	Leistung power	CCT	Lumen lumen	Art.-Nr. art.-no.	€ netto DE excl. VAT	€ brutto DE incl. VAT
	Leuchteneinheit L lighting unit L	LED	TRIAC	34 W	2700 K	3360 lm	LE014480	289,92 €	345,00 €
					3000 K	3480 lm	LE014483	289,92 €	345,00 €
			DALI	34 W	2700 K	3360 lm	LE014478	315,13 €	375,00 €
					3000 K	3480 lm	LE014481	315,13 €	375,00 €
	Glas L klar glass L clear						CU014475	310,92 €	370,00 €
	Glas L klar, Reflektor konisch glass L clear, reflector conical						CU014476	344,54 €	410,00 €
	Glas L klar, Reflektor zylindrisch glass L clear, reflector cylindrical						CU014477	344,54 €	410,00 €

REEF Ceiling

Die unverwechselbaren Leuchtschirme dieser Familie bestehen aus innovativer Schaumkeramik, deren Struktur stark an Korallen erinnert. Dabei sind sie durabel, spülmaschinentauglich und verteilen das Streulicht perfekt in einem sanften Bone China-Farbtönen. Die zylindrischen Körper sind einseitig offen – so strahlen die Leuchten dieser Familie kräftig und brillant, aber völlig blendfrei.

The unmistakable lamp shades in this family are made of innovative foam ceramic, whose texture is highly reminiscent of corals. That said they are durable, dishwasher-proof and distribute the scattered light perfectly in a gentle bone china hue. The cylindrical objects are open on one side, such that the lamps in this family shine powerfully and brightly, though without any glare at all.

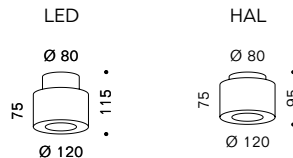

Licht light	nach unten gerichtet, rundum diffus directed downwards, diffuse all around
Leuchtmittel lamp	LED 8 W, CoB, CRI Ra>97 (R9>80), EEK/EEC F G9 max. 33 W, EEK/EEC G
Gehäuse Housing	Aluminium poliert oder gebürstet; Schirm: Keramikschaum weiß aluminium polished or brushed; shade: ceramic foam white
Sonstiges features	LED austauschbar, Schirm werkzeuglos abnehmbar und spülmaschinenfest LED exchangeable, shade tool-free removable and dishwasher safe

REEF Ceiling

Abbildung figure	Beschreibung description	Leuchtmittel lamp	Regelung control	Leistung power	CCT	Lumen lumen	Art.-Nr. art.-no.	€ netto DE excl. VAT	€ brutto DE incl. VAT
●	gebürstet brushed	LED	TRIAC	8 W	2700 K	790 lm	RF2007	336,13 €	400,00 €
		G9	TRIAC	max. 33 W	2700 K	460 lm	RF1012	210,08 €	250,00 €
●	poliert polished	LED	TRIAC	8 W	2700 K	790 lm	RF2009	344,54 €	410,00 €
		G9	TRIAC	max. 33 W	2700 K	460 lm	RF1017	218,49 €	260,00 €

DRAFT Ceiling

DRAFT Ceiling macht aus der archetypischen Kugelleuchte ein Objekt von zeitgenössischer Prägnanz und perfekt ausbalancierter Lichtwirkung. Die transparente, mundgeblasene Glaskugel und der lichtdurchlässige, mattweiße Innenreflektor treten in einen spannenden Kontrast. Das LED-Leuchtmittel tief im Inneren des konischen Reflektors sorgt rundum für weich gestreutes Raumlicht und gerichtetes Licht nach unten. Eine Diffusorscheibe gewährleistet einen besonders weichen Lichtaustritt und gleichmäßig beleuchtete Flächen. DRAFT ist absolut blendfrei, verfügt über zwei verschiedene Lichtfarben und die Dim2warm-Funktion.

DRAFT turns the archetypical spherical luminaire into an object that boasts an unpretentious contemporary look and perfectly balanced light. The transparent, hand-blown glass ball and the translucent, matte white internal reflector make for a striking contrast. Set deep in the internal reflector, the LED illuminant delivers softly diffused all-round and downward directional light. A diffuser plate ensures particularly soft light and evenly illuminated spaces. DRAFT is absolutely glare-free, comes with two different light colors and the Dim2warm function.

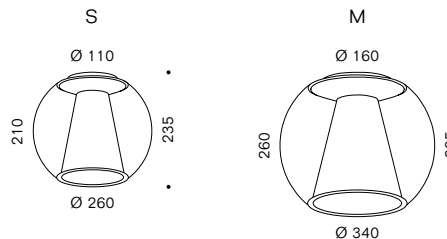

Leuchtmittel lamp	LED 11–20 W, CoB, CRI Ra>90 (R9>80), EEK/EEC F (2700 K, 3000 K), G (1800–3000 K D2W)
-----------------------------	--

Baldachin canopy	Aluminium hochglanzpoliert aluminum highly polished
----------------------------	---

Schirm shade	mundgeblasenes Glas klar, Reflektor Acrylglas opal hand-blown glass clear; reflector acrylic glass opal
------------------------	---

Ausführungen versions	Glasschirm klar, braun oder blau, Reflektor konisch opal; Licht: nach unten gerichtet, rundum weich gestreut glass shade clear, brown or blue reflector conical; light: directed downwards, diffused all around
---------------------------------	---



Sonstiges features	LED wechselbar, werkzeuglose Schirmmontage; 110 V-Varianten auf Anfrage; DALI-Varianten für den Einsatz in Notbeleuchtungsanlagen auf Anfrage LED exchangeable, shade tool-free mountable; 110 V versions on request; DALI versions for the use in emergency lighting systems on request
------------------------------	--

DRAFT ist ein modularer Artikel. Bitte jeweils Leuchteneinheit und Glasschirm zusammen bestellen.
DRAFT is a modular article. Please order the lighting unit and glass shade together.

DRAFT Ceiling S

Abbildung figure	Beschreibung description	Leuchtmittel lamp	Regelung control	Leistung power	CCT	Lumen lumen	Art.-Nr. art.-no.	€ netto DE excl. VAT	€ brutto DE incl. VAT
	Leuchteneinheit S lighting unit S	LED	TRIAC	11 W	2700 K	1130 lm	LE015701	180,67 €	215,00 €
					3000 K	1180 lm	LE015702	180,67 €	215,00 €
					1800–3000 K D2W	870 lm	LE015703	214,29 €	255,00 €
			DALI	11 W	2700 K	1130 lm	LE015730	205,88 €	245,00 €
					3000 K	1180 lm	LE015731	205,88 €	245,00 €
					1800–3000 K D2W	870 lm	LE015732	239,50 €	285,00 €

	Glas S klar mit Reflektor glass S clear with reflector						DR015728	247,90 €	295,00 €
---	--	--	--	--	--	--	----------	----------	----------

	Glas S braun mit Reflektor glass S brown with reflector						DR015729	285,71 €	340,00 €
---	---	--	--	--	--	--	----------	----------	----------

	Glas S blau mit Reflektor glass S blue with reflector						DR015730	285,71 €	340,00 €
---	---	--	--	--	--	--	----------	----------	----------

DRAFT Ceiling M

Abbildung figure	Beschreibung description	Leuchtmittel lamp	Regelung control	Leistung power	CCT	Lumen lumen	Art.-Nr. art.-no.	€ netto DE excl. VAT	€ brutto DE incl. VAT
	Leuchteneinheit M lighting unit M	LED	TRIAC	20 W	2700 K	1910 lm	LE015710	239,50 €	285,00 €
					3000 K	2010 lm	LE015711	239,50 €	285,00 €
					1800–3000 K D2W	1540 lm	LE015712	273,11 €	325,00 €
			DALI 1–10 V	20 W	2700 K	1910 lm	LE015713	264,71 €	315,00 €
					3000 K	2010 lm	LE015714	264,71 €	315,00 €
					1800–3000 K D2W	1540 lm	LE015715	298,32 €	355,00 €

	Glas M klar mit Reflektor glass M clear with reflector						DR015731	327,73 €	390,00 €
---	--	--	--	--	--	--	----------	----------	----------

	Glas M braun mit Reflektor glass M brown with reflector						DR015732	373,95 €	445,00 €
---	---	--	--	--	--	--	----------	----------	----------

	Glas M blau mit Reflektor glass M blue with reflector						DR015733	373,95 €	445,00 €
---	---	--	--	--	--	--	----------	----------	----------

DRUM Ceiling new

Mit ihrer zylindrischen Form passt DRUM Ceiling besonders gut zu geradliniger Architektur, in den Objektbereich oder in Privaträume. Die Kegelform des opalen Innenreflektors ist jeweils abhängig von Höhe und Durchmesser der transparenten Außenform aus Glas. In der jeweiligen Kombination entsteht so ein geometrisches Spiel von klaren Zylindern und Kegeln mit verschiedenen Winkeln im Inneren. DRUM Ceiling sorgt absolut blendfrei für mildes Raumlicht und gerichtetes Licht nach unten.

With its cylindrical shape DRUM Ceiling fits perfectly into clean-cut architecture, the contract world, or private spaces. The conical shape of the opaline internal reflector depends on the height and diameter of the transparent outer body made of glass. The respective combination gives rise to a geometric interplay of clear cylinders and cones with different angles on the inside. DRUM Ceiling provides absolutely glare-free mild ambient light and light that is directed carefully downwards.

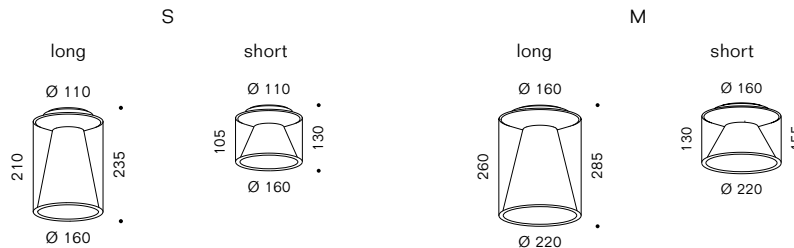

Licht
light **nach unten gerichtet, rundum weich gestreut**
directed downwards, diffused all around

Leuchtmittel
lamp LED 11–20 W, CoB, CRI Ra>90 (R9>80), EEK/EEC F (2700 K, 3000 K), G (1800–3000 K D2W)

Leuchteneinheit
lighting unit **Aluminium hochglanzpoliert**
aluminum highly polished

Glasschirm
glass shade **mundgeblasenes Glas klar, Reflektor Acrylglas opal**
hand-blown glass clear; reflector acrylic glass opal

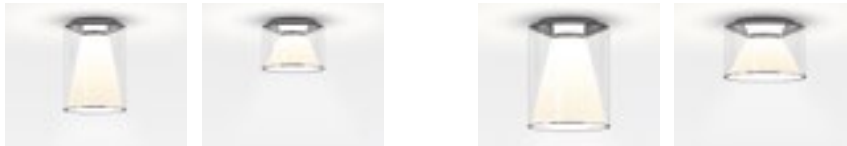

Ausführungen
versions





Sonstiges
features **LED wechselbar, werkzeuglose Schirmmontage; 110 V-Varianten auf Anfrage; DALI-Varianten für den Einsatz in Notbeleuchtungsanlagen auf Anfrage**
LED exchangeable, shade tool-free mountable; 110 V versions on request; DALI versions for the use in emergency lighting systems on request

DRUM ist ein modularer Artikel. Bitte jeweils Leuchteneinheit und Glasschirm zusammen bestellen.
DRUM is a modular article. Please order the lighting unit and glass shade together.

DRUM Ceiling S

Abbildung figure	Beschreibung description	Leuchtmittel lamp	Regelung control	Leistung power	CCT	Lumen lumen	Art.-Nr. art.-no.	€ netto DE excl. VAT	€ brutto DE incl. VAT		
	Leuchteneinheit S lighting unit S	LED	TRIAC	11 W	2700 K	1130 lm	LE015701	180,67 €	215,00 €		
					3000 K	1180 lm	LE015702	180,67 €	215,00 €		
					1800–3000 K D2W	870 lm	LE015703	214,29 €	255,00 €		
					DALI	11 W	2700 K	1130 lm	LE015730	205,88 €	245,00 €
							3000 K	1180 lm	LE015731	205,88 €	245,00 €
							1800–3000 K D2W	870 lm	LE015732	239,50 €	285,00 €
	Glas S long mit Reflektor glass S long with reflector						DU015801	189,08 €	225,00 €		
	Glas S short mit Reflektor glass S short with reflector						DU015802	142,86 €	170,00 €		

DRUM Ceiling M

Abbildung figure	Beschreibung description	Leuchtmittel lamp	Regelung control	Leistung power	CCT	Lumen lumen	Art.-Nr. art.-no.	€ netto DE excl. VAT	€ brutto DE incl. VAT		
	Leuchteneinheit M lighting unit M	LED	TRIAC	20 W	2700 K	1910 lm	LE015710	239,50 €	285,00 €		
					3000 K	2010 lm	LE015711	239,50 €	285,00 €		
					1800–3000 K D2W	1540 lm	LE015712	273,11 €	325,00 €		
					DALI 1–10 V	20 W	2700 K	1910 lm	LE015713	264,71 €	315,00 €
							3000 K	2010 lm	LE015714	264,71 €	315,00 €
							1800–3000 K D2W	1540 lm	LE015715	298,32 €	355,00 €
	Glas M long mit Reflektor glass M long with reflector						DU015803	222,69 €	265,00 €		
	Glas M short mit Reflektor glass M short with reflector						DU015804	172,27 €	205,00 €		

POPPY Ceiling

Werden die „Mohnblüten“ dieser Familie durch Einschalten geweckt, öffnen sich ihre Schirme ganz allmählich: die feinen Blätter sind aus Bimetall und dehnen sich durch Erwärmung aus. Alle Varianten können nach Belieben umgestaltet werden. Der flexible, textilmantelte Schlauch lässt sich immer neu biegen – zur Änderung der Lichtrichtung oder einfach weil Ihnen danach ist. Die mundgeblasenen Glaskapseln sind erhältlich den Farben keramik, rubinrot oder violett.

When the “poppy flowers” in this family are woken by the lamp being switched on, their shades open very gradually: the delicate leaves are bi-metallic and expand when heated. All the versions can be reshaped as desired. The flexible, textile-coated stem can be bent at will, to change the direction of the light, or because you just feel like it. The hand-blown glass capsules are available in ceramic, ruby red or violet.

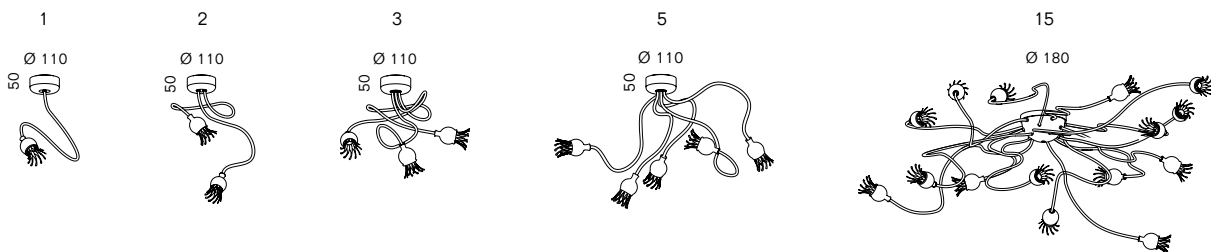







Licht light	nach vorne gerichtet, rundum dekorativ directed forward, decorative all around
Leuchtmittel lamp	POPPY Ceiling 1/2/3: 1 x/2 x/3 x G4 35 W, 12 V, EEK/EEC G POPPY Ceiling 5/15: 5 x/15 x G4 20 W, 12 V, EEK/EEC G
Größen sizes	1 bis 5 Arme: Länge der Arme 75 cm, 15 Arme: Länge der Arme 75 oder 150 cm 1 to 5 arms: length of arms 75 cm, 15 arms: length of arms 75 cm or 150 cm
Material material	Arme, flexibel: Aluminium, textilmantelt beige oder schwarz; Glasschirme: mundgeblasenes Glas in keramik, rubinrot oder violett; Lamellen: Bimetall; Baldachin: 1–5 Arme Edelstahl, poliert; 15 Arme: Edelstahl gebürstet arms, flexible: textile coated aluminium tube in beige or black; glass shade: hand-blown glass in ceramic, ruby red or violet lamellae: bimetal; canopy: 1–5 arms stainless steel, polished; 15 arms: stainless steel, brushed
Sonstiges features	Leuchtmittel in Lieferung enthalten; Reflektor-Lamellen öffnen sich nach ca. 2 Minuten Betriebszeit; Leuchte kann auch als Wandleuchte montiert werden lamps included in delivery; lamellae open within approx. 2 minutes after switching on luminaire; luminaire can also be mounted as wall luminaire







POPPY Ceiling 1

Abbildung figure	Beschreibung description	Fassung socket	Regelung control	Leistung power	Art.-Nr. art.-no.	€ netto DE excl. VAT	€ brutto DE incl. VAT
	1 Arm schwarz, Schirm keramik 1 arm black, shade ceramic	G4	ON/OFF	max. 35 W	PO1025	394,96 €	470,00 €
	1 Arm schwarz, Schirm rubinrot 1 arm black, shade ruby red	G4	ON/OFF	max. 35 W	PO1026	394,96 €	470,00 €
	1 Arm schwarz, Schirm violett 1 arm black, shade violet	G4	ON/OFF	max. 35 W	PO1027	394,96 €	470,00 €
	1 Arm beige, Schirm keramik 1 arm beige shade ceramic	G4	ON/OFF	max. 35 W	PO1028	394,96 €	470,00 €
	1 Arm beige, Schirm rubinrot 1 arm beige shade ruby red	G4	ON/OFF	max. 35 W	PO1029	394,96 €	470,00 €
	1 Arm beige, Schirm violett 1 arm beige shade violet	G4	ON/OFF	max. 35 W	PO1030	394,96 €	470,00 €







POPPY Ceiling 2

Abbildung figure	Beschreibung description	Fassung socket	Regelung control	Leistung power	Art.-Nr. art.-no.	€ netto DE excl. VAT	€ brutto DE incl. VAT
	2 Arme schwarz, Schirme keramik 2 arms black, shades ceramic	2 × G4	ON/OFF	max. 70 W	PO1031	495,80 €	590,00 €
	2 Arme schwarz, Schirme rubinrot 2 arms black, shades ruby red	2 × G4	ON/OFF	max. 70 W	PO1032	495,80 €	590,00 €
	2 Arme schwarz, Schirme violett 2 arms black, shades violet	2 × G4	ON/OFF	max. 70 W	PO1033	495,80 €	590,00 €
	2 Arme beige, Schirme keramik 2 arms beige shades ceramic	2 × G4	ON/OFF	max. 70 W	PO1034	495,80 €	590,00 €
	2 Arme beige, Schirme rubinrot 2 arms beige shades ruby red	2 × G4	ON/OFF	max. 70 W	PO1035	495,80 €	590,00 €
	2 Arme beige, Schirme violett 2 arms beige shades violet	2 × G4	ON/OFF	max. 70 W	PO1036	495,80 €	590,00 €







POPPY Ceiling 3

Abbildung figure	Beschreibung description	Fassung socket	Regelung control	Leistung power	Art.-Nr. art.-no.	€ netto DE excl. VAT	€ brutto DE incl. VAT
	3 Arme schwarz, Schirme keramik 3 arms black, shades ceramic	3 × G4	ON/OFF	max. 105 W	PO1037	596,64 €	710,00 €
	3 Arme schwarz, Schirme rubinrot 3 arms black, shades ruby red	3 × G4	ON/OFF	max. 105 W	PO1038	596,64 €	710,00 €
	3 Arme schwarz, Schirme violett 3 arms black, shades violet	3 × G4	ON/OFF	max. 105 W	PO1039	596,64 €	710,00 €
	3 Arme beige, Schirme keramik 3 arms beige shades ceramic	3 × G4	ON/OFF	max. 105 W	PO1040	596,64 €	710,00 €
	3 Arme beige, Schirme rubinrot 3 arms beige shades ruby red	3 × G4	ON/OFF	max. 105 W	PO1041	596,64 €	710,00 €
	3 Arme beige, Schirme violett 3 arms beige shades violet	3 × G4	ON/OFF	max. 105 W	PO1042	596,64 €	710,00 €

POPPY Ceiling 5

Abbildung figure	Beschreibung description	Fassung socket	Regelung control	Leistung power	Art.-Nr. art.-no.	€ netto DE excl. VAT	€ brutto DE incl. VAT
	5 Arme schwarz, Schirme keramik 5 arms black, shades ceramic	5 × G4	ON/OFF	max. 100 W	PO1043	773,11 €	920,00 €
	5 Arme schwarz, Schirme rubinrot 5 arms black, shades ruby red	5 × G4	ON/OFF	max. 100 W	PO1044	773,11 €	920,00 €
	5 Arme schwarz, Schirme violett 5 arms black, shades violet	5 × G4	ON/OFF	max. 100 W	PO1045	773,11 €	920,00 €
	5 Arme beige, Schirme keramik 5 arms beige shades ceramic	5 × G4	ON/OFF	max. 100 W	PO1046	773,11 €	920,00 €
	5 Arme beige, Schirme rubinrot 5 arms beige shades ruby red	5 × G4	ON/OFF	max. 100 W	PO1047	773,11 €	920,00 €
	5 Arme beige, Schirme violett 5 arms beige shades violet	5 × G4	ON/OFF	max. 100 W	PO1048	773,11 €	920,00 €

POPPY Ceiling 15

Abbildung figure	Beschreibung description	Fassung socket	Regelung control	Leistung power	Art.-Nr. art.-no.	€ netto DE excl. VAT	€ brutto DE incl. VAT
	15 Arme 75 cm schwarz, Schirme keramik 15 arms 75 cm black, shades ceramic	15 x G4	ON/OFF	max. 300 W	PO1007	1.764,71 €	2.100,00 €
	15 Arme 150 cm schwarz, Schirme keramik 15 arms 150 cm black, shades ceramic	15 x G4	ON/OFF	max. 300 W	PO1010	1.848,74 €	2.200,00 €
	15 Arme 75 cm schwarz, Schirme rubinrot 15 arms 75 cm black, shades ruby red	15 x G4	ON/OFF	max. 300 W	PO1008	1.764,71 €	2.100,00 €
	15 Arme 150 cm schwarz, Schirme rubinrot arms 150 cm black, shades ruby red	15 x G4	ON/OFF	max. 300 W	PO1011	1.848,74 €	2.200,00 €
	15 Arme 75 cm schwarz, Schirme violett 15 arms 75 cm black, shades violet	15 x G4	ON/OFF	max. 300 W	PO1009	1.764,71 €	2.100,00 €
	15 Arme 150 cm schwarz, Schirme violett 15 arms 150 cm black, shades violet	15 x G4	ON/OFF	max. 300 W	PO1012	1.848,74 €	2.200,00 €
	15 Arme 75 cm beige, Schirme keramik 15 arms 75 cm beige, shades ceramic	15 x G4	ON/OFF	max. 300 W	PO1013	1.764,71 €	2.100,00 €
	15 Arme 150 cm beige, Schirme keramik 15 arms 150 cm beige, shades ceramic	15 x G4	ON/OFF	max. 300 W	PO1016	1.848,74 €	2.200,00 €
	15 Arme 75 cm beige, Schirme rubinrot 15 arms 75 cm beige, shades ruby red	15 x G4	ON/OFF	max. 300 W	PO1014	1.764,71 €	2.100,00 €
	15 Arme 150 cm beige, Schirme rubinrot 15 arms 150 cm beige, shades ruby red	15 x G4	ON/OFF	max. 300 W	PO1017	1.848,74 €	2.200,00 €
	15 Arme 75 cm beige, Schirme violett 15 arms 75 cm beige, shades violet	15 x G4	ON/OFF	max. 300 W	PO1015	1.764,71 €	2.100,00 €
	15 Arme 150 cm beige, Schirme violett 15 arms 150 cm beige, shades violet	15 x G4	ON/OFF	max. 300 W	PO1018	1.848,74 €	2.200,00 €

Bei REFLEX² sorgt das auf einen eigenen Deckenreflektor strahlende Licht für eine überzeugende Lichtlösung am zentralen Deckenanschluss im Raum. REFLEX² besitzt eine feine, elegant abgerundete Rahmenstruktur, die LED-Platinen enthält. Sie strahlen auf eine Reflektorfläche im gleichen Grundmaß. REFLEX² bietet auch bei voller Leistung ein absolut blendfreies Licht, das optional per Bluetooth gesteuert werden kann. Aus einer dezenten Struktur entstehen so intensive Lichtstimmungen im Raum.



REFLEX² presents a convincing lighting solution at the central ceiling connection in a space by employing a special ceiling reflector. REFLEX² has delicate, elegantly rounded frame structure that contains the LED boards. Their light hits a reflector surface of the same basic dimensions. Even at full power, REFLEX² creates an absolutely glare-free light, whose color may further be adjusted optional via Bluetooth. As such, the subtle structure gives rise to intensive lighting moods in the space.

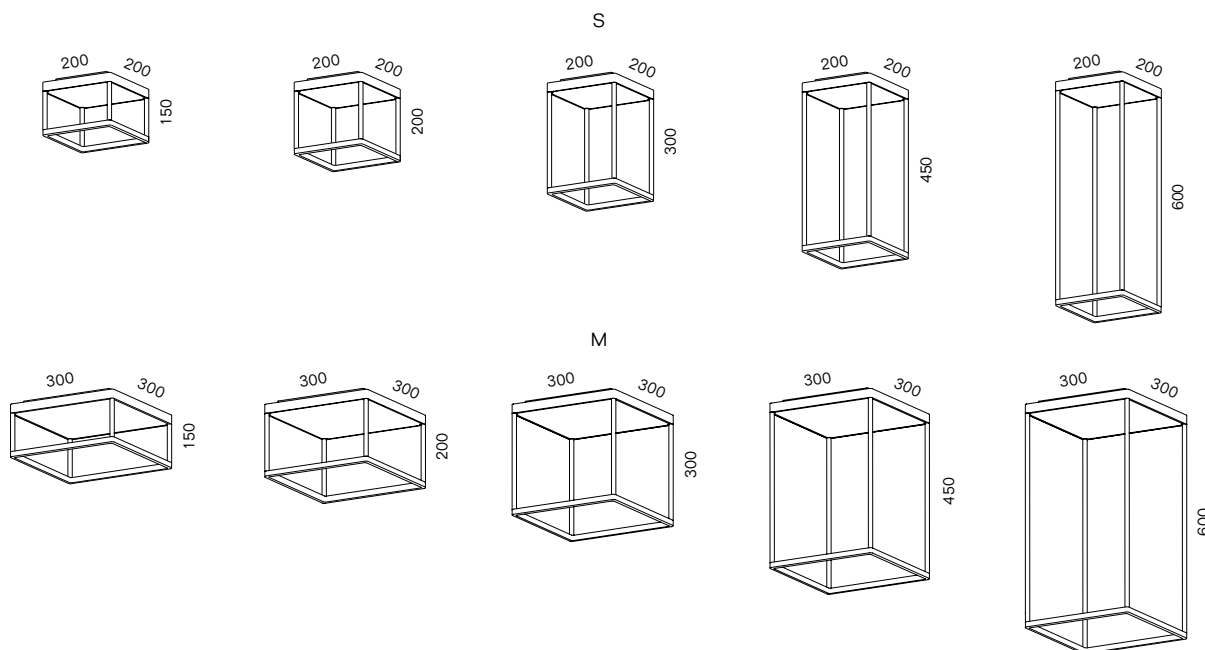

Licht
light **nach oben gestreut, indirekt über Deckenreflektor und Decke**
scattered upwards, diffuse all around due to reflector and ceiling

Leuchtmittel
lamp **LED 33–50 W, CRI Ra>90 (R9>50), EEK/EEC E**
S: 2700 K, 3000 K oder/or Dim2Warm, M: 2700 K, 3000 K oder/or 2200–4000 K/tunable white

Gehäuse
housing **Aluminium schwarz oder weiß beschichtet**
aluminium black or white coated

Material
material **Reflektor: PLEXIGLAS® Pyramidenstruktur oder PLEXIGLAS® matt; Leuchtmittelabdeckungen: Flachglas satinée**
reflector: PLEXIGLAS® pyramid structure or PLEXIGLAS® matte; lamp cover: glass semigloss

Sonstiges
features **+C kennzeichnet Produkte mit vorprogrammiertem CASAMBI-Modul in der Leuchte integriert. LED austauschbar; Einfache Montage; Reflektor einfach wechselbar; 110 V-Varianten auf Anfrage**
+C indicates products with pre-programmed CASAMBI module integrated in the luminaire.
LED exchangeable; easy assembly; reflector easily exchangeable; 110 V versions on request

REFLEX² ist ein modularer Artikel. Bitte jeweils Leuchteneinheit und Reflektor zusammen bestellen.
REFLEX² is a modular article. Please order the lamp unit and reflector together.

REFLEX² Ceiling S new versions available

Abbildung figure	Beschreibung description	Leuchtmittel lamp	Regelung control	Leistung power	CCT	Lumen lumen	Art.-Nr. art.-no.	€ netto DE excl. VAT	€ brutto DE incl. VAT			
●	150 schwarz 150 black	LED	TRIAC	33 W	2700 K new	3910 lm	RE2450	344,54 €	410,00 €			
					3000 K new	3960 lm	RE2451	344,54 €	410,00 €			
					2200–3000 K D2W	3910 lm	RE2401	382,35 €	455,00 €			
			DALI	33 W	2700 K new	3910 lm	RE2460	386,55 €	460,00 €			
					3000 K new	3960 lm	RE2461	386,55 €	460,00 €			
					2200–3000 K D2W	3910 lm	RE2402	424,37 €	505,00 €			
								2200–3000 K D2W + C	3910 lm	RE2402C	537,82 €	640,00 €
			○	150 weiß 150 white	LED	TRIAC	33 W	2700 K new	3910 lm	RE2452	344,54 €	410,00 €
								3000 K new	3960 lm	RE2453	344,54 €	410,00 €
2200–3000 K D2W	3910 lm	RE2403						382,35 €	455,00 €			
DALI	33 W	2700 K new				3910 lm	RE2462	386,55 €	460,00 €			
		3000 K new				3960 lm	RE2463	386,55 €	460,00 €			
		2200–3000 K D2W				3910 lm	RE2404	424,37 €	505,00 €			
						2200–3000 K D2W + C	3910 lm	RE2404C	537,82 €	640,00 €		
●	200 schwarz 200 black	LED				TRIAC	33 W	2700 K new	3910 lm	RE2550	344,54 €	410,00 €
								3000 K new	3960 lm	RE2551	344,54 €	410,00 €
			2200–3000 K D2W	3910 lm	RE2501			382,35 €	455,00 €			
			DALI	33 W	2700 K new	3910 lm	RE2560	386,55 €	460,00 €			
					3000 K new	3960 lm	RE2561	386,55 €	460,00 €			
					2200–3000 K D2W	3910 lm	RE2502	424,37 €	505,00 €			
								2200–3000 K D2W + C	3910 lm	RE2502C	537,82 €	640,00 €
			○	200 weiß 200 white	LED	TRIAC	33 W	2700 K new	3910 lm	RE2552	344,54 €	410,00 €
								3000 K new	3960 lm	RE2553	344,54 €	410,00 €
2200–3000 K D2W	3910 lm	RE2503						382,35 €	455,00 €			
DALI	33 W	2700 K new				3910 lm	RE2562	386,55 €	460,00 €			
		3000 K new				3960 lm	RE2563	386,55 €	460,00 €			
		2200–3000 K D2W				3910 lm	RE2504	424,37 €	505,00 €			
						2200–3000 K D2W + C	3910 lm	RE2504C	537,82 €	640,00 €		
●	300 schwarz 300 black	LED				TRIAC	33 W	2700 K new	3910 lm	RE2650	344,54 €	410,00 €
								3000 K new	3960 lm	RE2651	344,54 €	410,00 €
			2200–3000 K D2W	3910 lm	RE2601			382,35 €	455,00 €			
			DALI	33 W	2700 K new	3910 lm	RE2660	386,55 €	460,00 €			
					3000 K new	3960 lm	RE2661	386,55 €	460,00 €			
					2200–3000 K D2W	3910 lm	RE2602	424,37 €	505,00 €			
								2200–3000 K D2W + C	3910 lm	RE2602C	537,82 €	640,00 €
			○	300 weiß 300 white	LED	TRIAC	33 W	2700 K new	3910 lm	RE2652	344,54 €	410,00 €
								3000 K new	3960 lm	RE2653	344,54 €	410,00 €
2200–3000 K D2W	3910 lm	RE2603						382,35 €	455,00 €			
DALI	33 W	2700 K new				3910 lm	RE2662	386,55 €	460,00 €			
		3000 K new				3960 lm	RE2663	386,55 €	460,00 €			
		2200–3000 K D2W				3910 lm	RE2604	424,37 €	505,00 €			
						2200–3000 K D2W + C	3910 lm	RE2604C	537,82 €	640,00 €		

REFLEX² Ceiling S new versions available

Abbildung figure	Beschreibung description	Leuchtmittel lamp	Regelung control	Leistung power	CCT	Lumen lumen	Art.-Nr. art.-no.	€ netto DE excl. VAT	€ brutto DE incl. VAT
●	450 schwarz 450 black	LED	TRIAC	33 W	2700 K new	3910 lm	RE2750	344,54 €	410,00 €
					3000 K new	3960 lm	RE2751	344,54 €	410,00 €
					2200–3000 K D2W	3910 lm	RE2701	382,35 €	455,00 €
			DALI	33 W	2700 K new	3910 lm	RE2760	386,55 €	460,00 €
					3000 K new	3960 lm	RE2761	386,55 €	460,00 €
					2200–3000 K D2W	3910 lm	RE2702	424,37 €	505,00 €
				2200–3000 K D2W + C	3910 lm	RE2702C	537,82 €	640,00 €	
○	450 weiß 450 white	LED	TRIAC	33 W	2700 K new	3910 lm	RE2752	344,54 €	410,00 €
					3000 K new	3960 lm	RE2753	344,54 €	410,00 €
					2200–3000 K D2W	3910 lm	RE2703	382,35 €	455,00 €
			DALI	33 W	2700 K new	3910 lm	RE2762	386,55 €	460,00 €
					3000 K new	3960 lm	RE2763	386,55 €	460,00 €
					2200–3000 K D2W	3910 lm	RE2704	424,37 €	505,00 €
				2200–3000 K D2W + C	3910 lm	RE2704C	537,82 €	640,00 €	
●	600 schwarz 600 black	LED	TRIAC	33 W	2700 K new	3910 lm	RE2950	344,54 €	410,00 €
					3000 K new	3960 lm	RE2951	344,54 €	410,00 €
					2200–3000 K D2W	3910 lm	RE2901	382,35 €	455,00 €
			DALI	33 W	2700 K new	3910 lm	RE2960	386,55 €	460,00 €
					3000 K new	3960 lm	RE2961	386,55 €	460,00 €
					2200–3000 K D2W	3910 lm	RE2902	424,37 €	505,00 €
				2200–3000 K D2W + C	3910 lm	RE2902C	537,82 €	640,00 €	
○	600 weiß 600 white	LED	TRIAC	33 W	2700 K new	3910 lm	RE2952	344,54 €	410,00 €
					3000 K new	3960 lm	RE2953	344,54 €	410,00 €
					2200–3000 K D2W	3910 lm	RE2903	382,35 €	455,00 €
			DALI	33 W	2700 K new	3910 lm	RE2962	386,55 €	460,00 €
					3000 K new	3960 lm	RE2963	386,55 €	460,00 €
					2200–3000 K D2W	3910 lm	RE2904	424,37 €	505,00 €
				2200–3000 K D2W + C	3910 lm	RE2904C	537,82 €	640,00 €	

REFLEX² Ceiling S Reflektor

Abbildung figure	Beschreibung description	Art.-Nr. art.-no.	€ netto DE excl. VAT	€ brutto DE incl. VAT
○	Pyramidenstruktur weiß pyramid structure white	RE3051	84,03 €	100,00 €
●	Pyramidenstruktur silber pyramid structure silver	RE3052	84,03 €	100,00 €
●	Pyramidenstruktur gold pyramid structure gold	RE3053	84,03 €	100,00 €
○	matt weiß matte white	RE3054	84,03 €	100,00 €

REFLEX² Ceiling M

Abbildung figure	Beschreibung description	Leuchtmittel lamp	Regelung control	Leistung power	CCT	Lumen lumen	Art.-Nr. art.-no.	€ netto DE excl. VAT	€ brutto DE incl. VAT
●	150 schwarz 150 black	LED	TRIAC 0-10 V	40 W	2700 K	4900 lm	RE2001	525,21 €	625,00 €
					3000 K	5000 lm	RE2002	525,21 €	625,00 €
					2700 K	5700 lm	RE2003	571,43 €	680,00 €
			DALI	50 W	3000 K	5800 lm	RE2004	571,43 €	680,00 €
					2200-4000 K TW	6040 lm	RE2005	659,66 €	785,00 €
					2200-4000 K TW + C	6040 lm	RE2005C	785,71 €	935,00 €
○	150 weiß 150 white	LED	TRIAC 0-10 V	40 W	2700 K	4900 lm	RE2006	525,21 €	625,00 €
					3000 K	5000 lm	RE2007	525,21 €	625,00 €
					2700 K	5700 lm	RE2008	571,43 €	680,00 €
			DALI	50 W	3000 K	5800 lm	RE2009	571,43 €	680,00 €
					2200-4000 K TW	6040 lm	RE2010	659,66 €	785,00 €
					2200-4000 K TW + C	6040 lm	RE2010C	785,71 €	935,00 €
●	200 schwarz 200 black	LED	TRIAC 0-10 V	40 W	2700 K	4900 lm	RE2801	525,21 €	625,00 €
					3000 K	5000 lm	RE2802	525,21 €	625,00 €
					2700 K	5700 lm	RE2803	571,43 €	680,00 €
			DALI	50 W	3000 K	5800 lm	RE2804	571,43 €	680,00 €
					2200-4000 K TW	6040 lm	RE2805	659,66 €	785,00 €
					2200-4000 K TW + C	6040 lm	RE2805C	785,71 €	935,00 €
○	200 weiß 200 white	LED	TRIAC 0-10 V	40 W	2700 K	4900 lm	RE2806	525,21 €	625,00 €
					3000 K	5000 lm	RE2807	525,21 €	625,00 €
					2700 K	5700 lm	RE2808	571,43 €	680,00 €
			DALI	50 W	3000 K	5800 lm	RE2809	571,43 €	680,00 €
					2200-4000 K TW	6040 lm	RE2810	659,66 €	785,00 €
					2200-4000 K TW + C	6040 lm	RE2810C	785,71 €	935,00 €
●	300 schwarz 300 black	LED	TRIAC 0-10 V	40 W	2700 K	4900 lm	RE2101	525,21 €	625,00 €
					3000 K	5000 lm	RE2102	525,21 €	625,00 €
					2700 K	5700 lm	RE2103	571,43 €	680,00 €
			DALI	50 W	3000 K	5800 lm	RE2104	571,43 €	680,00 €
					2200-4000 K TW	6040 lm	RE2105	659,66 €	785,00 €
					2200-4000 K TW + C	6040 lm	RE2105C	785,71 €	935,00 €
○	300 weiß 300 white	LED	TRIAC 0-10 V	40 W	2700 K	4900 lm	RE2106	525,21 €	625,00 €
					3000 K	5000 lm	RE2107	525,21 €	625,00 €
					2700 K	5700 lm	RE2108	571,43 €	680,00 €
			DALI	50 W	3000 K	5800 lm	RE2109	571,43 €	680,00 €
					2200-4000 K TW	6040 lm	RE2110	659,66 €	785,00 €
					2200-4000 K TW + C	6040 lm	RE2110C	785,71 €	935,00 €
●	450 schwarz 450 black	LED	TRIAC 0-10 V	40 W	2700 K	4900 lm	RE2201	525,21 €	625,00 €
					3000 K	5000 lm	RE2202	525,21 €	625,00 €
					2700 K	5700 lm	RE2203	571,43 €	680,00 €
			DALI	50 W	3000 K	5800 lm	RE2204	571,43 €	680,00 €
					2200-4000 K TW	6040 lm	RE2205	659,66 €	785,00 €
					2200-4000 K TW + C	6040 lm	RE2205C	785,71 €	935,00 €
○	450 weiß 450 white	LED	TRIAC 0-10 V	40 W	2700 K	4900 lm	RE2206	525,21 €	625,00 €
					3000 K	5000 lm	RE2207	525,21 €	625,00 €
					2700 K	5700 lm	RE2208	571,43 €	680,00 €
			DALI	50 W	3000 K	5800 lm	RE2209	571,43 €	680,00 €
					2200-4000 K TW	6040 lm	RE2210	659,66 €	785,00 €
					2200-4000 K TW + C	6040 lm	RE2210C	785,71 €	935,00 €

Abbildung figure	Beschreibung description	Leuchtmittel lamp	Regelung control	Leistung power	CCT	Lumen lumen	Art.-Nr. art.-no.	€ netto DE excl. VAT	€ brutto DE incl. VAT
●	600 schwarz 600 black	LED	TRIAC 0–10 V	40 W	2700 K	4900 lm	RE2301	525,21 €	625,00 €
					3000 K	5000 lm	RE2302	525,21 €	625,00 €
					2700 K	5700 lm	RE2303	571,43 €	680,00 €
			DALI	50 W	3000 K	5800 lm	RE2304	571,43 €	680,00 €
					2200–4000 K TW	6040 lm	RE2305	659,66 €	785,00 €
					2200–4000 K TW + C	6040 lm	RE2305C	785,71 €	935,00 €
○	600 weiß 600 white	LED	TRIAC 0–10 V	40 W	2700 K	4900 lm	RE2306	525,21 €	625,00 €
					3000 K	5000 lm	RE2307	525,21 €	625,00 €
					2700 K	5700 lm	RE2308	571,43 €	680,00 €
			DALI	50 W	3000 K	5800 lm	RE2309	571,43 €	680,00 €
					2200–4000 K TW	6040 lm	RE2310	659,66 €	785,00 €
					2200–4000 K TW + C	6040 lm	RE2310C	785,71 €	935,00 €

REFLEX² Ceiling M Reflektor

Abbildung figure	Beschreibung description	Art.-Nr. art.-no.	€ netto DE excl. VAT	€ brutto DE incl. VAT
○	Pyramidenstruktur weiß pyramid structure white	RE3001	96,64 €	115,00 €
●	Pyramidenstruktur silber pyramid structure silver	RE3002	96,64 €	115,00 €
●	Pyramidenstruktur gold pyramid structure gold	RE3003	96,64 €	115,00 €
○	matt weiß matte white	RE3004	96,64 €	115,00 €

SLICE² PI Ceiling new available Q1 2023

Mit dem Kreis als perfekte Form bietet die Deckenleuchte SLICE² PI Ceiling die universelle Lichtlösung für alle Anforderungen moderner Architektur hinsichtlich Lichtleistung und Ausleuchtung. Ideales, blendfreies Licht wird seitlich über die Glaskante eingespeist und von einer mikroprismatischen Scheibe nach unten verteilt – Wahlweise mit zusätzlichem Indirektlicht zur Deckenaufhellung. Das komplett geschlossene Gehäuse, die Echtglasscheibe und der robuste Aluminiumring sind von substanzieller Qualität. Durch die einfache Montage mittels Bajonettverschluss, der sowohl mechanischen als auch elektrischen Kontakt herstellt, lassen sich problemlos auch große Projekte realisieren.

With the circle as the perfect shape, the SLICE² PI Ceiling luminaire offers the universal lighting solution for all requirements of modern architecture in terms of light output and illumination. Ideal, glare-free downward light is fed in laterally via the edge of the glass and distributed downward by a microprismatic pane – optionally with additional indirect light to lighten up the ceiling. The completely enclosed housing, the real glass pane and the robust aluminum ring are of substantial quality. Simple mounting by means of a bayonet catch, that establishes both mechanical and electrical contact, makes it easy to realise even large projects.

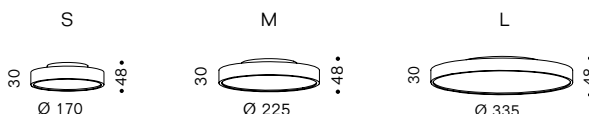

Licht light	nach unten entblendet durch Mikroprismen-Strukturglas, optional nach oben dezent diffus, UGR<19 downward glare-reduced by micro-prismatic structural glass; optional upward subtly diffused, UGR<19
-----------------------	--

Leuchtmittel lamp	LED 10/17/25 W, CRI Ra>95 (2700 K), CRI Ra>80 (3000 K), EEK/EEC E
-----------------------------	---







Gehäuse housing	Aluminium schwarz oder weiß beschichtet, Aluminium glanzverchromt aluminum black or white coated, aluminum chrome plated
---------------------------	--

Material material	Baldachin: opales Spritzgussgehäuse; Abdeckung Acrylglas Diffusor; Leuchteneinheit: Prismenstruktur-Acrylglas mit abschließender Echtglasscheibe canopy: injection moulded housing opal, cover acrylic diffuser; lighting unit: prismatic structured acrylic glass sealed by real glass pane
-----------------------------	---









Sonstiges features	einfache Montage durch Bajonettverschluss easy assembly through bayonet lock
------------------------------	--







SLICE² PI Ceiling S

Abbildung figure	Beschreibung description	Leuchtmittel lamp	Regelung control	Leistung power	CCT	Lumen lumen	Art.-Nr. art.-no.	€ netto DE excl. VAT	€ brutto DE incl. VAT
	Treibereinheit S driver unit S		TRIAC	10 W			DE011001	67,23 €	80,00 €
			DALI	10 W			DE011002	84,03 €	100,00 €
● 	Gehäuse S schwarz housing S black	LED			2700 K	1160 lm	PI1001	239,50 €	285,00 €
					3000 K	1460 lm	PI1002	239,50 €	285,00 €
● 	Gehäuse S schwarz, mit Indirektlicht housing S black, with indirect light	LED			2700 K	1160 lm	PI1011	239,50 €	285,00 €
					3000 K	1460 lm	PI1012	239,50 €	285,00 €
○ 	Gehäuse S weiß housing S white	LED			2700 K	1160 lm	PI1021	239,50 €	285,00 €
					3000 K	1460 lm	PI1022	239,50 €	285,00 €
○ 	Gehäuse S weiß, mit Indirektlicht housing S white, with indirect light	LED			2700 K	1160 lm	PI1031	239,50 €	285,00 €
					3000 K	1460 lm	PI1032	239,50 €	285,00 €
● 	Gehäuse S glanzverchromt housing S chrome-plated	LED			2700 K	1160 lm	PI1041	273,11 €	325,00 €
					3000 K	1460 lm	PI1042	273,11 €	325,00 €
● 	Gehäuse S glanzverchromt, mit Indirektlicht housing S chrome-plated, with indirect light	LED			2700 K	1160 lm	PI1051	273,11 €	325,00 €
					3000 K	1460 lm	PI1052	273,11 €	325,00 €

SLICE² PI Ceiling M

Abbildung figure	Beschreibung description	Leuchtmittel lamp	Regelung control	Leistung power	CCT	Lumen lumen	Art.-Nr. art.-no.	€ netto DE excl. VAT	€ brutto DE incl. VAT
	Treibereinheit M driver unit M		TRIAC	17 W			DE011011	79,83 €	95,00 €
			DALI	17 W			DE011012	113,45 €	135,00 €
● 	Gehäuse M schwarz housing M black	LED			2700 K	2160 lm	PI1101	327,73 €	390,00 €
					3000 K	2730 lm	PI1102	327,73 €	390,00 €
● 	Gehäuse M schwarz, mit Indirektlicht housing M black, with indirect light	LED			2700 K	2160 lm	PI1111	327,73 €	390,00 €
					3000 K	2730 lm	PI1112	327,73 €	390,00 €
○ 	Gehäuse M weiß housing M white	LED			2700 K	2160 lm	PI1121	327,73 €	390,00 €
					3000 K	2730 lm	PI1122	327,73 €	390,00 €
○ 	Gehäuse M weiß, mit Indirektlicht housing M white, with indirect light	LED			2700 K	2160 lm	PI1131	327,73 €	390,00 €
					3000 K	2730 lm	PI1132	327,73 €	390,00 €
● 	Gehäuse M glanzverchromt housing M chrome-plated	LED			2700 K	2160 lm	PI1141	369,75 €	440,00 €
					3000 K	2730 lm	PI1142	369,75 €	440,00 €
● 	Gehäuse M glanzverchromt, mit Indirektlicht housing M chrome-plated, with indirect light	LED			2700 K	2160 lm	PI1151	369,75 €	440,00 €
					3000 K	2730 lm	PI1152	369,75 €	440,00 €

SLICE² PI Ceiling L

Abbildung figure	Beschreibung description	Leuchtmittel lamp	Regelung control	Leistung power	CCT	Lumen lumen	Art.-Nr. art.-no.	€ netto DE excl. VAT	€ brutto DE incl. VAT
	Treibereinheit L driver unit L		TRIAC	25 W			DE011021	105,04 €	125,00 €
			DALI	25 W			DE011022	142,86 €	170,00 €
● 	Gehäuse L schwarz housing L black	LED			2700 K	3230 lm	PI1201	445,38 €	530,00 €
					3000 K	4100 lm	PI1202	445,38 €	530,00 €
● 	Gehäuse L schwarz, mit Indirektlicht housing L black, with indirect light	LED			2700 K	3230 lm	PI1211	445,38 €	530,00 €
					3000 K	4100 lm	PI1212	445,38 €	530,00 €
○ 	Gehäuse L weiß housing L white	LED			2700 K	3230 lm	PI1221	445,38 €	530,00 €
					3000 K	4100 lm	PI1222	445,38 €	530,00 €
○ 	Gehäuse L weiß, mit Indirektlicht housing L white, with indirect light	LED			2700 K	3230 lm	PI1231	445,38 €	530,00 €
					3000 K	4100 lm	PI1232	445,38 €	530,00 €
● 	Gehäuse L glanzverchromt housing L chrome-plated	LED			2700 K	3230 lm	PI1241	504,20 €	600,00 €
					3000 K	4100 lm	PI1242	504,20 €	600,00 €
● 	Gehäuse L glanzverchromt, mit Indirektlicht housing L chrome-plated, with indirect light	LED			2700 K	3230 lm	PI1251	504,20 €	600,00 €
					3000 K	4100 lm	PI1252	504,20 €	600,00 €

ANNEX Ceiling L
reflector: opal glass



ANNEX Ceiling M
reflector: opal glass



ANNEX Ceiling S
reflector: opal glass



ANNEX Ceiling L
reflector: polished aluminum



ANNEX Ceiling M
reflector: polished aluminum



ANNEX Ceiling S
reflector: polished aluminum



ANNEX Ceiling L
reflector: crystal glass



ANNEX Ceiling M
reflector: crystal glass



ANNEX Ceiling S
reflector: crystal glass















CAVITY Ceiling | CAVITY Recessed • black



CAVITY Ceiling | CAVITY Recessed • white





CAVITY Ceiling | CAVITY Recessed • aluminium gloss finish



CAVITY Ceiling | CAVITY Recessed • bronze finish





shade: glass clear
reflector: conical opal



shade: glass clear
reflector: cylindrical opal



shade: glass clear



shade: acrylic glass clear
reflector: conical opal



shade: acrylic glass clear
reflector: cylindrical opal



shade: acrylic glass clear













DRAFT Ceiling M • clear



DRAFT Ceiling S • clear



DRAFT Ceiling M • brown



DRAFT Ceiling S • brown



DRAFT Ceiling M • blue

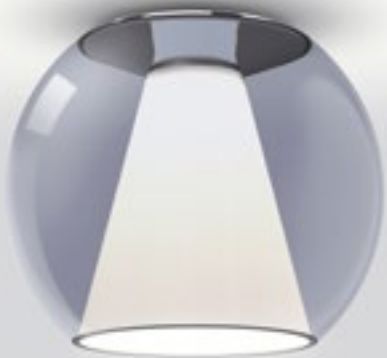

DRAFT Ceiling S • blue





DRUM Ceiling M • long



DRUM Ceiling S • long



DRUM Ceiling M • short



DRUM Ceiling S • short











REEF Ceiling • brushed



CEILING

REEF Ceiling • brushed





reflector: pyramid white



reflector: pyramid silver

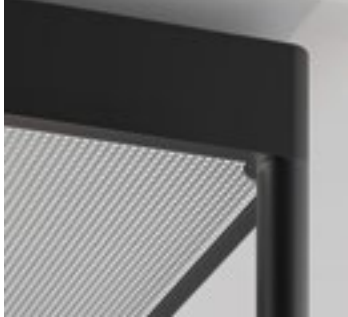

reflector: pyramid gold

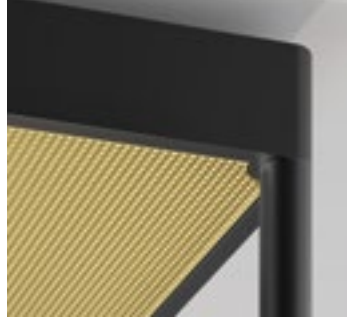

reflector: matte white













SLICE² PI Ceiling L · black



SLICE² PI Ceiling M · black



SLICE² PI Ceiling S · black



SLICE² PI Ceiling L · white



SLICE² PI Ceiling M · white



SLICE² PI Ceiling S · white



SLICE² PI Ceiling L · chrome



SLICE² PI Ceiling M · chrome



SLICE² PI Ceiling S · chrome







ANNEX
S. 58

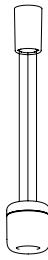

CAVITY
S. 60



CURLING
S. 62



DRAFT
S. 66

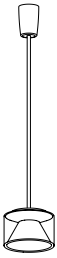

DRUM
S. 68
new

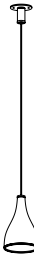

ONE EIGHTY
S. 70

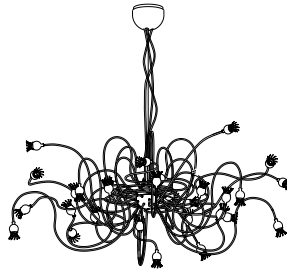

POPPY
S. 72

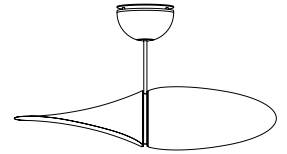

PROPELLER
S. 73

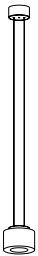

REEF
S. 74

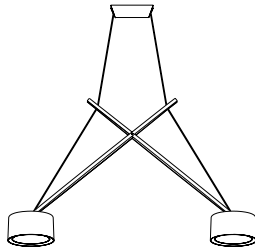

TWIN
S. 75

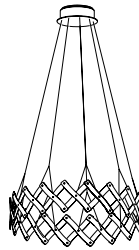

ZOOM
S. 76

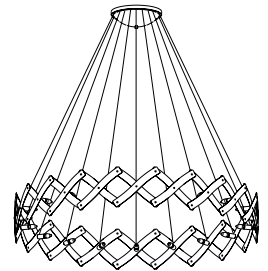

ZOOM XL
S. 76

ANNEX Suspension

Eine geradezu archetypische Deckenleuchte mit dem Mehr an Funktionalität, auf das wir Wert legen: drei verschiedene Größen korrespondieren mit den Proportionen Ihrer Räume. Mit den unterschiedlichen Reflektoren im Innern des mundgeblasenen Kegelschirms lassen sich äußerst differenzierte Lichtwirkungen erzielen, die formal dennoch einer Familie angehören.

An almost archetypal ceiling light with more functionality that we value: three different sizes correspond with the proportions of your rooms. The different reflectors inside the hand-blown cone shade make it possible to achieve extremely differentiated lighting effects that formally belong to a family.



DESIGN PLUS

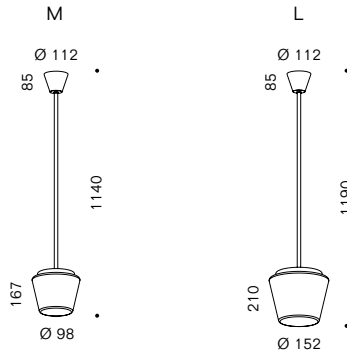

Leuchtmittel
lamp LED 20–41 W, CoB, CRI Ra>97 (R9>80), EEK/EEC E (3000 K), F (2700 K)

Leuchteneinheit
light unit Aluminium, hochglanzpoliert und weiß beschichtet
aluminum, highly polished and coated white

Schirm
shade mundgeblasenes Glas klar
hand-blown glass clear

Abhängung
suspension Stahlrohr verchromt
chromed steel tube

Ausführungen
versions



Glasschirm klar, Reflektor Acrylglas opal
Licht: nach unten gerichtet, rundum gestreut
glass shade clear, reflector acrylic glass opal
light: directed downwards, distributed all around





Glasschirm klar, Reflektor Aluminium poliert
Licht: nach unten gerichtet, rundum diffus
glass shade clear, reflector: aluminium polished
light: directed downwards, diffused all around





Glasschirm klar, Reflektor Kristallglas geschliffen mit Aluminium-Innenreflektor
Licht: nach unten gerichtet, rundum dekorativ
glass shade clear, reflector crystal glass with aluminium reflector cut crystal glass
light: directed downwards, diffused all around

Sonstiges
features LED austauschbar; werkzeuglose Schirmmontage; 110 V-Varianten auf Anfrage
LED exchangeable; glass shade tool-free mountable; 110 V versions on request

ANNEX Suspension M

Abbildung figure	Beschreibung description	Leuchtmittel lamp	Regelung control	Leistung power	CCT	Lumen lumen	Art.-Nr. art.-no.	€ netto DE excl. VAT	€ brutto DE incl. VAT
	Reflektor opal reflector opal	LED	TRIAC	20 W	2700 K	1450 lm	AN3101	609,24 €	725,00 €
					3000 K	1500 lm	AN3102	609,24 €	725,00 €
			DALI	27 W	2700 K	2900 lm	AN3105	642,86 €	765,00 €
					3000 K	3000 lm	AN3106	642,86 €	765,00 €
	Reflektor poliert reflector polished	LED	TRIAC	20 W	2700 K	1450 lm	AN3111	642,86 €	765,00 €
					3000 K	1500 lm	AN3112	642,86 €	765,00 €
			DALI	27 W	2700 K	2900 lm	AN3116	676,47 €	805,00 €
					3000 K	3000 lm	AN3117	676,47 €	805,00 €
	Reflektor Kristall reflector crystal	LED	TRIAC	20 W	2700 K	1450 lm	AN3121	747,90 €	890,00 €
					3000 K	1500 lm	AN3122	747,90 €	890,00 €
			DALI	27 W	2700 K	2900 lm	AN3125	781,51 €	930,00 €
					3000 K	3000 lm	AN3126	781,51 €	930,00 €

ANNEX Suspension L

Abbildung figure	Beschreibung description	Leuchtmittel lamp	Regelung control	Leistung power	CCT	Lumen lumen	Art.-Nr. art.-no.	€ netto DE excl. VAT	€ brutto DE incl. VAT
	Reflektor opal reflector opal	LED	TRIAC	34 W	2700 K	3850 lm	AN3147	680,67 €	810,00 €
					3000 K	4010 lm	AN3148	680,67 €	810,00 €
			DALI	41 W	2700 K	4500 lm	AN3151	722,69 €	860,00 €
					3000 K	4680 lm	AN3152	722,69 €	860,00 €
	Reflektor poliert reflector polished	LED	TRIAC	34 W	2700 K	3850 lm	AN3153	722,69 €	860,00 €
					3000 K	4010 lm	AN3154	722,69 €	860,00 €
			DALI	41 W	2700 K	4500 lm	AN3157	764,71 €	910,00 €
					3000 K	4680 lm	AN3158	764,71 €	910,00 €
	Reflektor Kristall reflector crystal	LED	TRIAC	34 W	2700 K	3850 lm	AN3141	882,35 €	1.050,00 €
					3000 K	4010 lm	AN3142	882,35 €	1.050,00 €
			DALI	41 W	2700 K	4500 lm	AN3145	924,37 €	1.100,00 €
					3000 K	4680 lm	AN3146	924,37 €	1.100,00 €

CAVITY Suspension

Ein speziell konzipierter, kurvenförmiger Aluminiumkörper mit vertieft sitzendem Leuchtmittel ersetzt beim Strahler CAVITY den Reflektor und erlaubt eine freie Entfaltung des Lichts, das über die Trichterform scheinbar nach außen fließt. Es entsteht ein Downlight mit einem blendfreien und sanften Licht, das aus jedem Winkel angenehm wirkt. Unterschiedliche Beleuchtungsaufgaben können einheitlich durch Kombination der Wandleuchten mit Aufbau- und Einbaustrahlern sowie den Pendelleuchten dieser Produktfamilie gelöst werden.

A specially designed, curved aluminum body including the recessed illuminant replaces the reflector in spotlight CAVITY and allows the light to unfold freely, seemingly flowing outwards via the funnel shaped form. The result is a glare-free and soft downlight, that is pleasant from all angles. Different lighting tasks can be solved consistently by combining the wall luminaires with surface-mounted and recessed spotlights and the pendant luminaires of this product family.

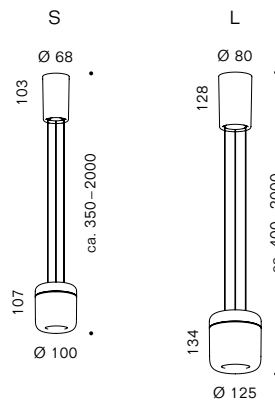

Licht
light **nach unten gerichtet, seitlich abgeschirmt**
directed downwards, shielded to the sides

Leuchtmittel
lamp LED 12–20 W, CoB, CRI Ra>95 (R9>80), EEK/EEC F

Gehäuse
housing **Aluminium schwarz oder weiß beschichtet, Aluminiumglanz finish oder Bronze finish**
aluminum black or white coated, aluminum gloss finish or bronze finish

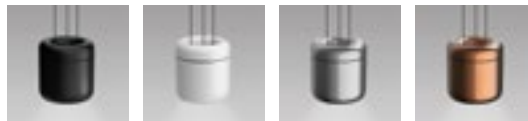

Sonstiges
features **LED austauschbar, werkzeuglose Gehäusemontage; geeignet für Deckenhöhen bis 3 m, Sonderlängen und 110 V-Varianten auf Anfrage**
LED exchangeable; housing tool-free mountable; suitable for ceiling heights up to 3 m, special lengths and 110 V versions on request

CAVITY Suspension S

Abbildung figure	Beschreibung description	Leuchtmittel lamp	Regelung control	Leistung power	CCT	Lumen lumen	Art.-Nr. art.-no.	€ netto DE excl. VAT	€ brutto DE incl. VAT
●	schwarz black	LED	TRIAC	12 W	2700 K	1220 lm	CA1101	327,73 €	390,00 €
					3000 K	1280 lm	CA1102	327,73 €	390,00 €
○	weiß white	LED	TRIAC	12 W	2700 K	1220 lm	CA1103	327,73 €	390,00 €
					3000 K	1280 lm	CA1104	327,73 €	390,00 €
●	Aluminiumglanz finish aluminum gloss finish	LED	TRIAC	12 W	2700 K	1220 lm	CA1105	394,96 €	470,00 €
					3000 K	1280 lm	CA1106	394,96 €	470,00 €
●	Bronze finish bronze finish	LED	TRIAC	12 W	2700 K	1220 lm	CA1107	394,96 €	470,00 €
					3000 K	1280 lm	CA1108	394,96 €	470,00 €

CAVITY Suspension L

Abbildung figure	Beschreibung description	Leuchtmittel lamp	Regelung control	Leistung power	CCT	Lumen lumen	Art.-Nr. art.-no.	€ netto DE excl. VAT	€ brutto DE incl. VAT
●	schwarz black	LED	TRIAC	20 W	2700 K	2070 lm	CA2101	457,98 €	545,00 €
					3000 K	2140 lm	CA2102	457,98 €	545,00 €
			DALI	20 W	2700 K	2070 lm	CA2105	512,61 €	610,00 €
					3000 K	2140 lm	CA2106	512,61 €	610,00 €
○	weiß white	LED	TRIAC	20 W	2700 K	2070 lm	CA2107	457,98 €	545,00 €
					3000 K	2140 lm	CA2108	457,98 €	545,00 €
			DALI	20 W	2700 K	2070 lm	CA2111	512,61 €	610,00 €
					3000 K	2140 lm	CA2112	512,61 €	610,00 €
●	Aluminiumglanz finish aluminum gloss finish	LED	TRIAC	20 W	2700 K	2070 lm	CA2113	546,22 €	650,00 €
					3000 K	2140 lm	CA2114	546,22 €	650,00 €
			DALI	20 W	2700 K	2070 lm	CA2117	600,84 €	715,00 €
					3000 K	2140 lm	CA2118	600,84 €	715,00 €
●	Bronze finish bronze finish	LED	TRIAC	20 W	2700 K	2070 lm	CA2119	546,22 €	650,00 €
					3000 K	2140 lm	CA2120	546,22 €	650,00 €
			DALI	20 W	2700 K	2070 lm	CA2123	600,84 €	715,00 €
					3000 K	2140 lm	CA2124	600,84 €	715,00 €

CAVITY Suspension L – Zubehör / Accessories

Baldachinprofil
Canopy profiles

Baldachine für die Montage von 2 oder 3 CAVITY Suspension L an einem Deckenauslass finden Sie auf den Seiten 198–199.
Canopies for mounting 2 or 3 CAVITY Suspension L on one ceiling outlet can be found on pages 198–199.

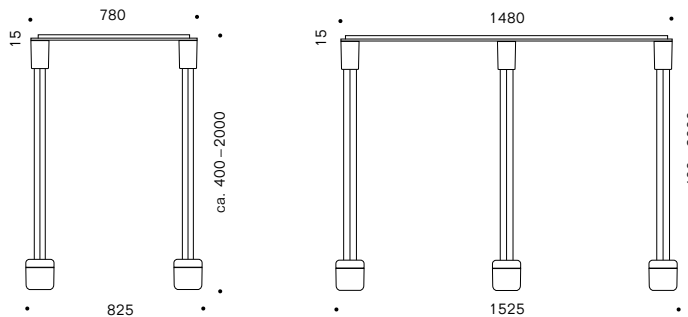

CAVITY Suspension L

CURLING Suspension

Klare Formen und intelligente Gestaltungsdetails machen CURLING Suspension zum universell einsetzbaren Downlight und Raumlicht in einem. Das ermöglicht besonders bei hohen Decken für jede Raumsituation und jede Raumhöhe die perfekte Lichtstimmung. CURLING Suspension kombiniert nach unten gerichtetes Direktlicht mit sanftem Raumlicht. Versionen mit Acrylglasschirm in kantiger Ästhetik erweitert das Einsatzspektrum von CURLING und ermöglichen einen optimalen Einsatz in Schulen, Kindergärten, Treppenhäusern und anderen Verkehrswegen im halböffentlichen oder öffentlichen Raum.



With its clear shape and intelligent design CURLING Suspension is an all-round downlight and ceiling light rolled into one. This means that in any setting you can rely on the perfect light mood. CURLING Suspension combines light directed downward with softly diffusing ambient light. Versions with acrylic glass shade in angular aesthetics expand CURLING's range of applications and enable optimal use in schools, kindergartens, stairwells and other paths in semi-public and public spaces.

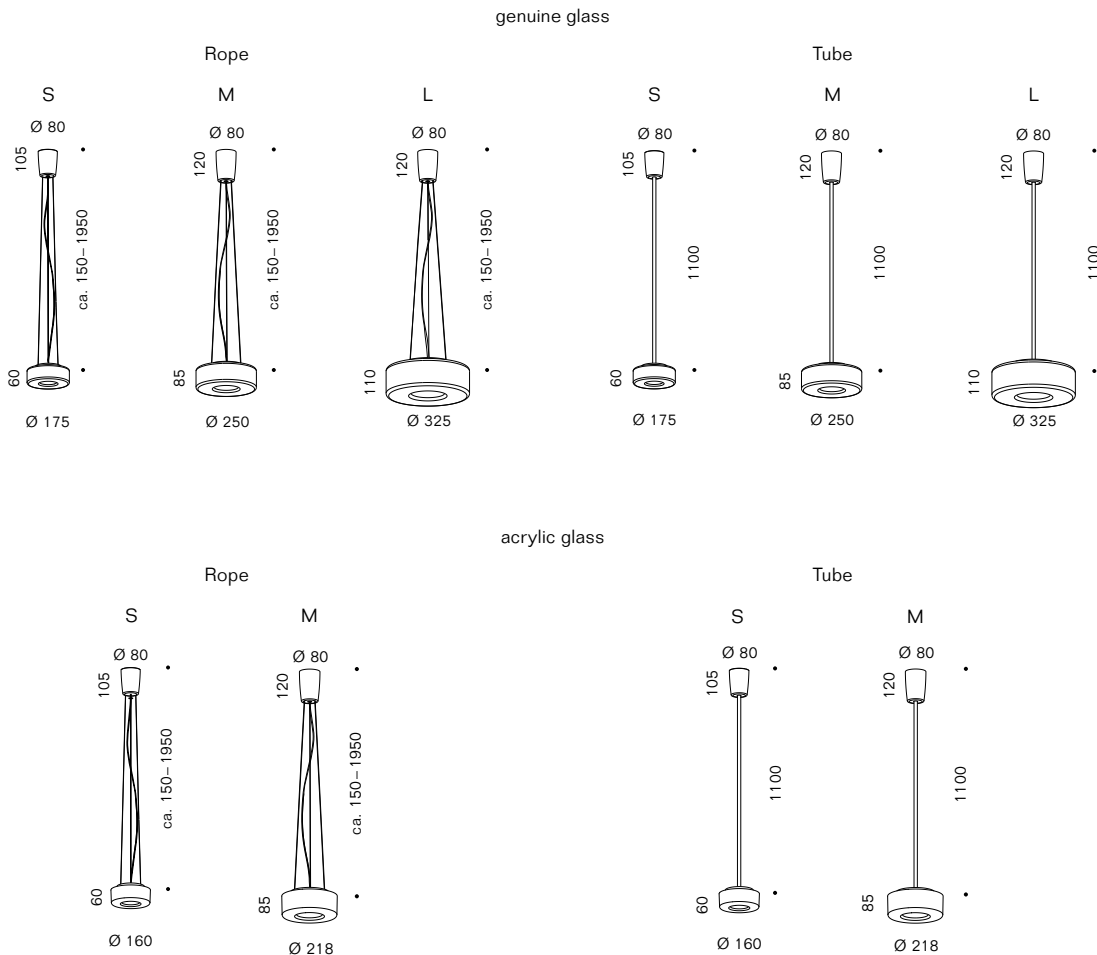

Leuchtmittel lamp	LED 11–34 W, CoB, CRI Ra>97 (R9>80), EEK/EEC F (2700 K, 3000 K), G (1800–3000 K D2W)
Leuchteneinheit light unit	Aluminium hochglanzpoliert aluminum highly polished
Abhängung suspension	Edelstahlseil oder Stahlrohr verchromt stainless steel rope or chromed steel tube

Schirm shade	mundgeblasenes Glas klar, opal oder metallisiert Reflektor: Polycarbonat opal mundgeblasenes Glas klar, opal oder metallisiert Reflektor: Polycarbonat opal	Acrylglas klar Reflektor: Polycarbonat opal Acrylic glass clear reflector: polycarbonate opal
Ausführungen versions	 Glasschirm klar Licht: nach unten gerichtet, rundum abstrahlend glass shade clear light: directed downwards, distributed all around	 Acrylglasschirm klar Licht: nach unten gerichtet, rundum abstrahlend acrylic glass shade clear light: directed downwards, distributed all around
	 Glasschirm klar, Reflektor konisch Licht: nach unten gerichtet, rundum weich gestreut glass shade clear, reflector conical light: directed downwards, diffused all around	 Acrylglasschirm klar, Reflektor konisch Licht: nach unten gerichtet, rundum weich gestreut acrylic glass shade clear, reflector conical light: directed downwards, diffused all around
	 Glasschirm klar, Reflektor zylindrisch Licht: nach unten gerichtet, rundum weich gestreut shade glass clear, reflector cylindrical light: directed downwards, diffused all around	 Acrylglasschirm klar, Reflektor zylindrisch Licht: nach unten gerichtet, rundum weich gestreut acrylic glass shade clear, reflector cylindrical light: directed downwards, diffused all around
	 Glasschirm opal Licht: nach unten gerichtet, rundum weich gestreut glass shade opal light: directed downwards, diffused all around	
	 Glasschirm neusilber Licht: nach unten gerichtet, rundum abstrahlend glass shade new silver light: directed downwards, distributed all around	
Sonstiges features	LED wechselbar, werkzeuglose Schirmmontage; 110 V-Varianten auf Anfrage; DALI-Varianten für den Einsatz in Notbeleuchtungsanlagen auf Anfrage LED exchangeable, shade tool-free mountable; 110 V versions on request; DALI versions for the use in emergency lighting systems on request	

CURLING ist ein modularer Artikel. Bitte jeweils Leuchteneinheit und Glasschirm zusammen bestellen.
CURLING is a modular article. Please order the lighting unit and glass shade together.





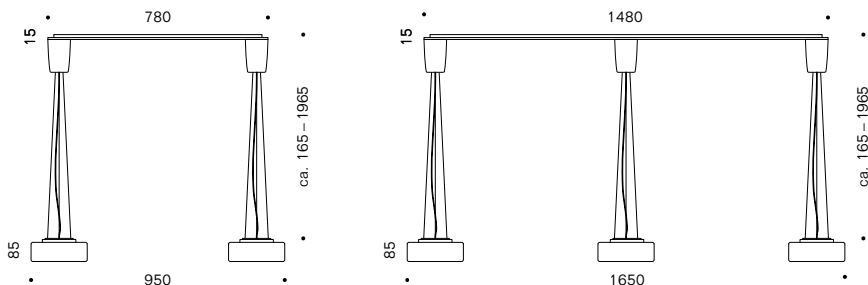





CURLING Suspension S/M – Zubehör / Accessories

Baldachinprofile Baldachine für 2 oder 3 CURLING Suspension an einem Deckenauslass finden Sie auf Seiten 198–199.
Canopy profiles Canopies for mounting zwei oder drei of CURLING Suspension on one ceiling outlet can be found on pages 198–199.













CURLING Suspension Rope M





CURLING Suspension S

Abbildung figure	Beschreibung description	Leuchtmittel lamp	Regelung control	Leistung power	CCT	Lumen lumen	Art.-Nr. art.-no.	€ netto DE € excl. VAT	brutto DE € incl. VAT
	Rope Leuchteinheit S Rope lighting unit S	LED	TRIAC	11 W	2700 K	1130 lm	LE015704	352,94 €	420,00 €
					3000 K	1180 lm	LE015705	352,94 €	420,00 €
					1800–3000 K D2W	870 lm	LE015706	382,35 €	455,00 €
			DALI	11 W	2700 K	1130 lm	LE015735	382,35 €	455,00 €
					3000 K	1180 lm	LE015736	382,35 €	455,00 €
					1800–3000 K D2W	870 lm	LE015737	411,76 €	490,00 €
	Tube Leuchteinheit S Tube lighting unit S	LED	TRIAC	11 W	2700 K	1130 lm	LE015707	315,13 €	375,00 €
					3000 K	1180 lm	LE015708	315,13 €	375,00 €
					1800–3000 K D2W	870 lm	LE015709	344,54 €	410,00 €
			DALI	11 W	2700 K	1130 lm	LE015740	344,54 €	410,00 €
					3000 K	1180 lm	LE015741	344,54 €	410,00 €
					1800–3000 K D2W	870 lm	LE015742	373,95 €	445,00 €
	Glas S klar glass S clear						CU014406	180,67 €	215,00 €
	Glas S klar, Reflektor konisch glass S clear, reflector conical						CU014407	201,68 €	240,00 €
	Glas S klar, Reflektor zylindrisch glass S clear, reflector cylindrical						CU014408	201,68 €	240,00 €
	Glas S opal glass S opal						CU014405	172,27 €	205,00 €
	Glas S neusilber glass S new silver						CU011201	243,70 €	290,00 €
	Acrylglas S klar acrylic glass S clear						CU011203	75,63 €	90,00 €
	Acrylglas S klar, Reflektor konisch acrylic glass S clear, reflector conical						CU011204	92,44 €	110,00 €
	Acrylglas S klar, Reflektor zylindrisch acrylic glass S clear, reflector cylindrical						CU011205	92,44 €	110,00 €

CURLING Suspension M

Abbildung figure	Beschreibung description	Leuchtmittel lamp	Regelung control	Leistung power	CCT	Lumen lumen	Art.-Nr. art.-no.	€ netto DE excl. VAT	€ brutto DE incl. VAT
	Rope Leuchteneinheit M Rope lighting unit M	LED	TRIAC 0–10 V	27 W	2700 K	2610 lm	LE015716	424,37 €	505,00 €
					3000 K	2750 lm	LE015717	424,37 €	505,00 €
					1800–3000 K D2W	2180 lm	LE015718	462,18 €	550,00 €
			DALI	27 W	2700 K	2610 lm	LE015719	453,78 €	540,00 €
					3000 K	2750 lm	LE015720	453,78 €	540,00 €
					1800–3000 K D2W	2180 lm	LE015721	491,60 €	585,00 €
	Tube Leuchteneinheit M Tube lighting unit M	LED	TRIAC 0–10 V	27 W	2700 K	2610 lm	LE015722	382,35 €	455,00 €
					3000 K	2750 lm	LE015723	382,35 €	455,00 €
					1800–3000 K D2W	2180 lm	LE015724	420,17 €	500,00 €
			DALI	27 W	2700 K	2610 lm	LE015725	411,76 €	490,00 €
					3000 K	2750 lm	LE015726	411,76 €	490,00 €
					1800–3000 K D2W	2180 lm	LE015727	449,58 €	535,00 €
	Glas M klar glass M clear						CU014402	226,89 €	270,00 €
	Glas M klar, Reflektor konisch glass M clear, reflector conical						CU014403	252,10 €	300,00 €
	Glas M klar, Reflektor zylindrisch glass M clear, reflector cylindrical						CU014404	252,10 €	300,00 €
	Glas M opal glass M opal						CU014401	214,29 €	255,00 €
	Glas M neusilber glass M new silver						CU011202	306,72 €	365,00 €
	Acrylglas M klar acrylic glass M clear						CU011206	100,84 €	120,00 €
	Acrylglas M klar, Reflektor konisch acrylic glass M clear, reflector conical						CU011207	126,05 €	150,00 €
	Acrylglas M klar, Reflektor zylindrisch acrylic glass M clear, reflector cylindrical						CU011208	126,05 €	150,00 €

CURLING Suspension L

Abbildung figure	Beschreibung description	Leuchtmittel lamp	Regelung control	Leistung power	CCT	Lumen lumen	Art.-Nr. art.-no.	€ netto DE excl. VAT	€ brutto DE incl. VAT			
	Rope Leuchteneinheit L Rope lighting unit L	LED	TRIAC	34 W	2700 K	3360 lm	LE014486	462,18 €	550,00 €			
					3000 K	3480 lm	LE014489	462,18 €	550,00 €			
					DALI	34 W	2700 K	3360 lm	LE014484	500,00 €	595,00 €	
			3000 K	3480 lm	LE014487		500,00 €	595,00 €				
				Tube Leuchteneinheit L Tube lighting unit L	LED	TRIAC	34 W	2700 K	3360 lm	LE014492	415,97 €	495,00 €
								3000 K	3480 lm	LE014495	415,97 €	495,00 €
DALI	34 W	2700 K						3360 lm	LE014490	453,78 €	540,00 €	
3000 K		3480 lm				LE014493	453,78 €	540,00 €				
	Glas L klar glass clear									CU014475	310,92 €	370,00 €
	Glas L klar, Reflektor konisch glass clear, reflector conical									CU014476	344,54 €	410,00 €
	Glas L klar, Reflektor zylindrisch glass clear, reflector cylindrical						CU014477	344,54 €	410,00 €			

DRAFT Suspension

DRAFT macht aus der archetypischen Kugelleuchte ein Objekt von zeitgenössischer Prägnanz und perfekt ausbalancierter Lichtwirkung. Die transparente, mundgeblasene Glaskugel und der lichtdurchlässige, mattweiße Innenreflektor treten in einen spannenden Kontrast. Das LED-Leuchtmittel tief im Inneren des konischen Reflektors sorgt rundum für weich gestreutes Raumlicht und gerichtetes Licht nach unten. Eine Diffusorscheibe gewährleistet einen besonders weichen Lichtaustritt und gleichmäßig beleuchtete Flächen. DRAFT ist absolut blendfrei, verfügt über zwei verschiedene Lichtfarben und die Dim2warm-Funktion.

DRAFT turns the archetypal spherical luminaire into an object that boasts an unpretentious contemporary look and perfectly balanced light. The transparent, hand-blown glass ball and the translucent, matte white internal reflector make for a striking contrast. Set deep in the internal reflector, the LED illuminant delivers softly diffused all-round and downward directional light. A diffuser plate ensures particularly soft light and evenly illuminated spaces. DRAFT is absolutely glare-free, comes with two different light colors and the Dim2warm function.

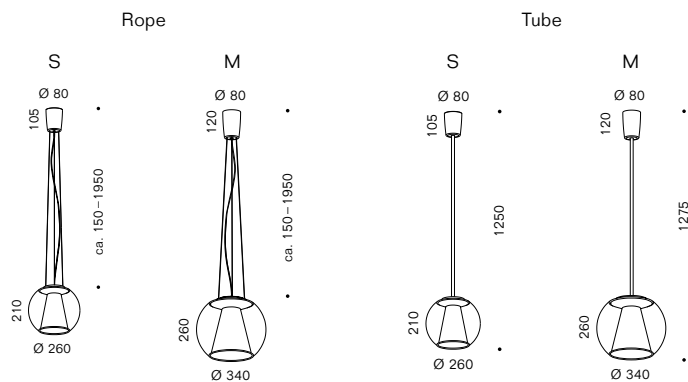

Leuchtmittel
lamp LED 11-27 W, CoB, CRI Ra>97 (R9>80), EEK/EEC F (2700 K, 3000 K), G (1800-3000 K D2W)

Leuchteneinheit
light unit **Aluminium hochglanzpoliert**
aluminum highly polished

Schirm
shade **mundgeblasenes Glas klar, Reflektor: Acrylglas opal**
hand-blown glass clear; reflector: acrylic glass opal





Ausführungen
versions **Glasschirm klar, Reflektor konisch opal; Licht: nach unten gerichtet, rundum weich gestreut**
glass shade clear, reflector conical; light: directed downwards, diffused all around





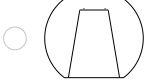
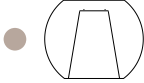

Sonstiges
features **LED wechselbar, werkzeuglose Schirmmontage; 110 V-Varianten auf Anfrage;**
DALI-Varianten für den Einsatz in Notbeleuchtungsanlagen auf Anfrage
LED exchangeable, shade tool-free mountable; 110 V versions on request;
DALI Versions for the use in emergency lighting systems on request

DRAFT ist ein modularer Artikel. Bitte jeweils Leuchteneinheit und Glasschirm zusammen bestellen.
DRAFT is a modular article. Please order the lighting unit and glass shade together.

DRAFT Suspension S

Abbildung figure	Beschreibung description	Leuchtmittel lamp	Regelung control	Leistung power	CCT	Lumen lumen	Art.-Nr. art.-no.	€ netto DE excl. VAT	€ brutto DE incl. VAT
	Rope Leuchteinheit S Rope lighting unit S	LED	TRIAC	11 W	2700 K	1130 lm	LE015704	352,94 €	420,00 €
					3000 K	1180 lm	LE015705	352,94 €	420,00 €
					1800–3000 K D2W	870 lm	LE015706	382,35 €	455,00 €
			DALI	11 W	2700 K	1130 lm	LE015735	382,35 €	455,00 €
					3000 K	1180 lm	LE015736	382,35 €	455,00 €
					1800–3000 K D2W	870 lm	LE015737	411,76 €	490,00 €
	Tube Leuchteinheit S Tube lighting unit S	LED	TRIAC	11 W	2700 K	1130 lm	LE015707	315,13 €	375,00 €
					3000 K	1180 lm	LE015708	315,13 €	375,00 €
					1800–3000 K D2W	870 lm	LE015709	344,54 €	410,00 €
			DALI	11 W	2700 K	1130 lm	LE015740	344,54 €	410,00 €
					3000 K	1180 lm	LE015741	344,54 €	410,00 €
					1800–3000 K D2W	870 lm	LE015742	373,95 €	445,00 €
	Glas S klar mit Reflektor glass S clear with reflector						DR015728	247,90 €	295,00 €
	Glas S braun mit Reflektor glass S brown with reflector						DR015729	285,71 €	340,00 €
	Glas S blau mit Reflektor glass S blue with reflector						DR015730	285,71 €	340,00 €

DRAFT Suspension M

Abbildung figure	Beschreibung description	Leuchtmittel lamp	Regelung control	Leistung power	CCT	Lumen lumen	Art.-Nr. art.-no.	€ netto DE excl. VAT	€ brutto DE incl. VAT
	Rope Leuchteinheit M Rope lighting unit M	LED	TRIAC	27 W	2700 K	2610 lm	LE015716	424,37 €	505,00 €
					3000 K	2750 lm	LE015717	424,37 €	505,00 €
					1800–3000 K D2W	2180 lm	LE015718	462,18 €	550,00 €
			DALI	27 W	2700 K	2610 lm	LE015719	453,78 €	540,00 €
					3000 K	2750 lm	LE015720	453,78 €	540,00 €
					1800–3000 K D2W	2180 lm	LE015721	491,60 €	585,00 €
	Tube Leuchteinheit M Tube lighting unit M	LED	TRIAC	27 W	2700 K	2610 lm	LE015722	382,35 €	455,00 €
					3000 K	2750 lm	LE015723	382,35 €	455,00 €
					1800–3000 K D2W	2180 lm	LE015724	420,17 €	500,00 €
			DALI	27 W	2700 K	2610 lm	LE015725	411,76 €	490,00 €
					3000 K	2750 lm	LE015726	411,76 €	490,00 €
					1800–3000 K D2W	2180 lm	LE015727	449,58 €	535,00 €
	Glas M klar mit Reflektor glass M clear with reflector						DR015731	327,73 €	390,00 €
	Glas M braun mit Reflektor glass M brown with reflector						DR015732	373,95 €	445,00 €
	Glas M blau mit Reflektor glass M blue with reflector						DR015733	373,95 €	445,00 €

DRAFT Suspension S / M – Zubehör / Accessories

Baldachinprofile Baldachine für die Montage von zwei oder drei DRAFT Suspension an nur einem Deckenauslass finden Sie auf Seiten 198–199.
Canopy profiles Canopies for mounting 2 or drei DRUM Suspension on only one ceiling outlet can be found on pages 198–199.

DRUM Suspension new

DRUM Suspension holt die schlichte Zylinderform von der Decke in den Raum und spielt mit dem geometrisch angepassten Volumen des opalen Innenreflektors. **DRUM Suspension Tube** passt mit ihrem rundum mild gestreuten Licht und gerichtetem Licht nach unten besonders gut in Flure oder Treppenhäuser, **DRUM Suspension Rope** mit ihrer feinen Stahlseilabhängung über Tische und Theken. **DRUM** ist absolut blendfrei, verfügt über zwei verschiedene Lichtfarben und die Dim2warm-Funktion.

DRUM Suspension brings the straightforward cylindrical shape down into the room and playfully deploys the geometrically adjusted volume of the opale internal reflector. DRUM Suspension Tube which diffuses light so mildly right round, directing light carefully downward, is ideal for corridors or stairwells, DRUM Suspension Rope with its fine steel cable suspension fits well over tables or bar tops. DRUM is absolutely glare-free, comes with two different light colors and the Dim2warm function.

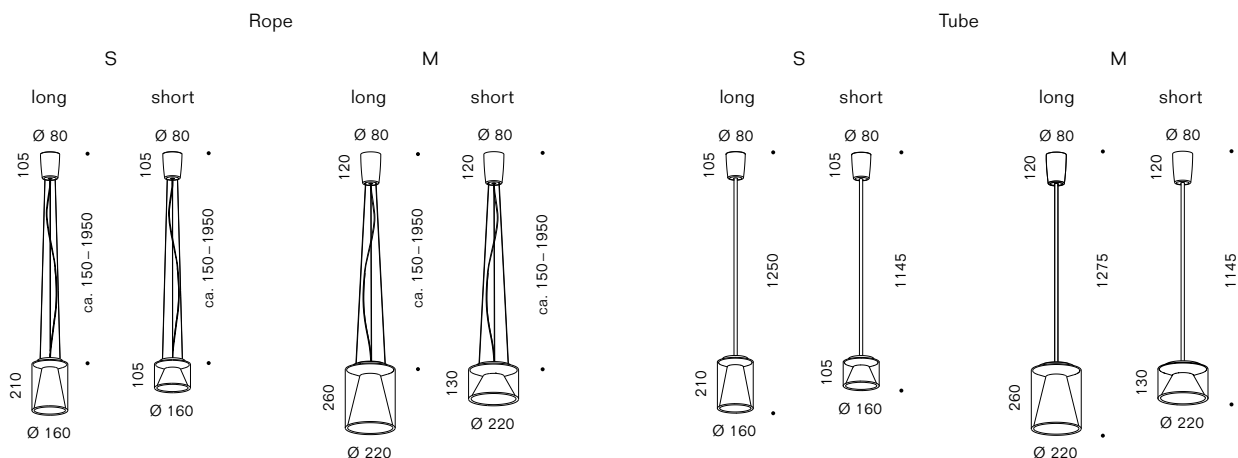

Licht
light **nach unten gerichtet, rundum weich gestreut**
directed downwards, diffused all around

Leuchtmittel
lamp LED 11-27 W, CoB, CRI Ra>97 (R9>80), EEK/EEC F (2700 K, 3000 K), G (1800-3000 K D2W)

Leuchteneinheit
light unit **Aluminium hochglanzpoliert**
aluminum highly polished

Glasschirm
glass shade **mundgeblasenes Glas klar, Reflektor: Acrylglas opal**
hand-blown glass clear; reflector: acrylic glass opal

Abhängung
suspension **Edelstahlseil oder Stahlrohr verchromt**
stainless steel rope or chromed steel tube



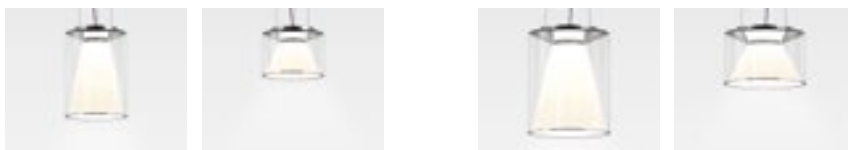

Ausführungen
versions







Sonstiges
features **LED wechselbar, werkzeuglose Schirmmontage; 110 V-Varianten auf Anfrage; DALI-Varianten für den Einsatz in Notbeleuchtungsanlagen auf Anfrage**
LED exchangeable, shade tool-free mountable; 110 V versions on request; DALI versions for the use in emergency lighting systems on request

DRUM ist ein modularer Artikel. Bitte jeweils Leuchteneinheit und Glasschirm zusammen bestellen.
DRUM is a modular article. Please order the lighting unit and glass shade together.

DRUM Suspension S

Abbildung figure	Beschreibung description	Leuchtmittel lamp	Regelung control	Leistung power	CCT	Lumen lumen	Art.-Nr. art.-no.	€ netto DE excl. VAT	€ brutto DE incl. VAT
	Rope Leuchteinheit S Rope lighting unit S	LED	TRIAC	11 W	2700 K	1130 lm	LE015704	352,94 €	420,00 €
					3000 K	1180 lm	LE015705	352,94 €	420,00 €
					1800–3000 K D2W	870 lm	LE015706	382,35 €	455,00 €
			DALI	11 W	2700 K	1130 lm	LE015735	382,35 €	455,00 €
					3000 K	1180 lm	LE015736	382,35 €	455,00 €
					1800–3000 K D2W	870 lm	LE015737	411,76 €	490,00 €
	Tube Leuchteinheit S Tube lighting unit S	LED	TRIAC	11 W	2700 K	1130 lm	LE015707	315,13 €	375,00 €
					3000 K	1180 lm	LE015708	315,13 €	375,00 €
					1800–3000 K D2W	870 lm	LE015709	344,54 €	410,00 €
			DALI	11 W	2700 K	1130 lm	LE015740	344,54 €	410,00 €
					3000 K	1180 lm	LE015741	344,54 €	410,00 €
					1800–3000 K D2W	870 lm	LE015742	373,95 €	445,00 €
	Glas S long mit Reflektor glass S long with reflector						DU015801	189,08 €	225,00 €
	Glas S short mit Reflektor glass S short with reflector						DU015802	142,86 €	170,00 €

DRUM Suspension M

Abbildung figure	Beschreibung description	Leuchtmittel lamp	Regelung control	Leistung power	CCT	Lumen lumen	Art.-Nr. art.-no.	€ netto DE excl. VAT	€ brutto DE incl. VAT
	Rope Leuchteinheit M Rope lighting unit M	LED	TRIAC	27 W	2700 K	2610 lm	LE015716	424,37 €	505,00 €
					3000 K	2750 lm	LE015717	424,37 €	505,00 €
					1800–3000 K D2W	2180 lm	LE015718	462,18 €	550,00 €
			DALI	27 W	2700 K	2610 lm	LE015719	453,78 €	540,00 €
					3000 K	2750 lm	LE015720	453,78 €	540,00 €
					1800–3000 K D2W	2180 lm	LE015721	491,60 €	585,00 €
	Tube Leuchteinheit M Tube lighting unit M	LED	TRIAC	27 W	2700 K	2610 lm	LE015722	382,35 €	455,00 €
					3000 K	2750 lm	LE015723	382,35 €	455,00 €
					1800–3000 K D2W	2180 lm	LE015724	420,17 €	500,00 €
			DALI	27 W	2700 K	2610 lm	LE015725	411,76 €	490,00 €
					3000 K	2750 lm	LE015726	411,76 €	490,00 €
					1800–3000 K D2W	2180 lm	LE015727	449,58 €	535,00 €
	Glas M long mit Reflektor glass M long with reflector						DU015803	222,69 €	265,00 €
	Glas M short mit Reflektor glass M short with reflector						DU015804	172,27 €	205,00 €

DRUM Suspension S/M – Zubehör / Accessories

Baldachinprofile Baldachine für die Montage von zwei oder drei DRUM Suspension an nur einem Deckenauslass finden Sie auf Seiten 198–199.
Canopy profiles Canopies for mounting two or three DRUM Suspension on only one ceiling outlet can be found on pages 198–199.

ONE EIGHTY Suspension

Als Pendelversion besonders geeignet auch zur Reihung mehrerer Leuchten, wirkt ONE EIGHTY Suspension unaufdringlich elegant. Mit zwei Schirmgrößen und zahlreichen Varianten, wahlweise mit einstellbarer Festlänge oder bequemer Höhenverstellung (Adjustable) kann jede Situation perfekt ausgeleuchtet werden.

Also particularly suitable for lining up rows of lamps, as a suspended version ONE EIGHTY Suspension makes an unobtrusive, elegant impression. With two shade sizes and numerous versions, available with optional set length or easy height adjustment, every situation can be lit perfectly.

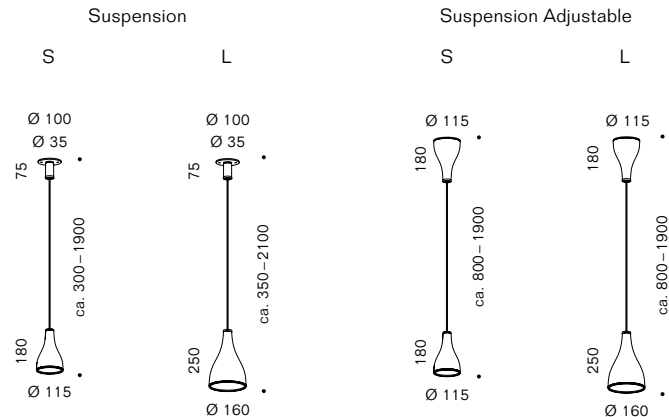



Licht
light **nach vorne gerichtet, seitlich abgeschirmt**
directed forward, shielded to the sides

Leuchtmittel
lamp **S: GU10, L: E27 (Lieferung ohne Leuchtmittel)**
S: GU10, L: E27 (delivery without bulb)



Baldachin & Schirm
canopy & shade **Aluminium gebürstet, weiß oder schwarz lackiert; Zierringe: Stahl vernickelt**
brushed aluminium with protective coating, coated white or black; decorative rings: steel nickel plated





ONE EIGHTY Suspension S

Abbildung figure	Beschreibung description	Fassung socket	Regelung control	Leistung power	Art.-Nr. art.-no.	€ netto DE excl. VAT	€ brutto DE incl. VAT
	gebürstet brushed	GU10	TRIAC	max. 60	OE1001	336,13 €	400,00 €
	schwarz black	GU10	TRIAC	max. 60	OE1021	336,13 €	400,00 €
	weiß white	GU10	TRIAC	max. 60	OE1003	336,13 €	400,00 €



ONE EIGHTY Suspension Adjustable S

Abbildung figure	Beschreibung description	Fassung socket	Regelung control	Leistung power	Art.-Nr. art.-no.	€ netto DE excl. VAT	€ brutto DE incl. VAT
	gebürstet brushed	GU10	TRIAC	max. 60	OE1002	420,17 €	500,00 €
	schwarz black	GU10	TRIAC	max. 60	OE1022	420,17 €	500,00 €
	weiß white	GU10	TRIAC	max. 60	OE1004	420,17 €	500,00 €

ONE EIGHTY Suspension L

Abbildung figure	Beschreibung description	Fassung socket	Regelung control	Leistung power	Art.-Nr. art.-no.	€ netto DE excl. VAT	€ brutto DE incl. VAT
	gebürstet brushed	E27	TRIAC	max. 100	OE1005	378,15 €	450,00 €
	schwarz black	E27	TRIAC	max. 100	OE1023	378,15 €	450,00 €
	weiß white	E27	TRIAC	max. 100	OE1007	378,15 €	450,00 €

ONE EIGHTY Suspension Adjustable L

Abbildung figure	Beschreibung description	Fassung socket	Regelung control	Leistung power	Art.-Nr. art.-no.	€ netto DE excl. VAT	€ brutto DE incl. VAT
	gebürstet brushed	E27	TRIAC	max. 100	OE1006	478,99 €	570,00 €
	schwarz black	E27	TRIAC	max. 100	OE1024	478,99 €	570,00 €
	weiß white	E27	TRIAC	max. 100	OE1008	478,99 €	570,00 €

POPPY Suspension

Werden die „Mohnblüten“ dieser Familie durch Einschalten geweckt, öffnen sich ihre Schirme ganz allmählich: die feinen Blätter sind aus Bimetall und dehnen sich durch Erwärmung aus. Alle Varianten können nach Belieben umgestaltet werden. Der flexible, textilmantelte Schlauch lässt sich immer neu biegen – zur Änderung der Lichtrichtung, oder einfach weil Ihnen danach ist. Die mundgeblasenen Glaskapseln sind erhältlich in den Farben keramik, rubinrot oder violett.

When the “poppy flowers” in this family are woken by the lamp being switched on, their shades open very gradually: the delicate leaves are bi-metallic and expand when heated. All the versions can be reshaped as desired. The flexible, textile-coated stem can be bent at will, to change the direction of the light, or because you just feel like it. The hand-blown glass capsules are available in ceramic, ruby red or violet.

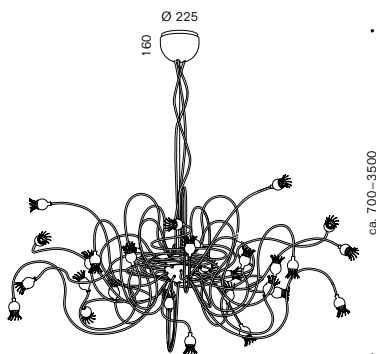

Licht
light **nach vorne gerichtet, rundum dekorativ**
directed forward, decorative all around

Leuchtmittel
lamp **30 x G4 20 W, 12 V, EEK/EEC G**

Material
material **30 Arme, flexibel: Aluminium, textilmantelt beige oder schwarz, Länge 150 cm; Glasschirme: mundgeblasenes Glas in keramik, rubinrot oder violett; Lamellen: Bimetall. Baldachin: Edelstahl gebürstet**
30 arms, flexible: textile coated aluminium tube in beige or black; length 150 cm
glass shade: hand-blown glass in ceramic, ruby red or violet; lamellae: bimetal; canopy: stainless steel, polished

Sonstiges
features **Leuchtmittel in Lieferung enthalten; Reflektor-Lamellen öffnen sich nach ca. 2 Minuten Betriebszeit**
lamps included in delivery; lamellae open within approx. 2 minutes after switching on luminaire

POPPY Suspension

Abbildung figure	Beschreibung description	Fassung socket	Regelung control	Leistung power	Art.-Nr. art.-no.	€ netto DE excl. VAT	€ brutto DE incl. VAT
	30 Arme schwarz, Schirme keramik 30 arms black, shades ceramic	30 x G4	ON/OFF	max. 600 W	PO1004	4.369,75 €	5.200,00 €
	30 Arme schwarz, Schirme rubinrot 30 arms black, shades red	30 x G4	ON/OFF	max. 600 W	PO1005	4.369,75 €	5.200,00 €
	30 Arme schwarz, Schirme violett 30 arms black, shades violet	30 x G4	ON/OFF	max. 600 W	PO1006	4.369,75 €	5.200,00 €
	30 Arme beige, Schirme keramik 30 arms beige shades ceramic	30 x G4	ON/OFF	max. 600 W	PO1019	4.369,75 €	5.200,00 €
	30 Arme beige, Schirme rubinrot 30 arms beige shades red	30 x G4	ON/OFF	max. 600 W	PO1020	4.369,75 €	5.200,00 €
	30 Arme beige, Schirme violett 30 arms beige shades violet	30 x G4	ON/OFF	max. 600 W	PO1021	4.369,75 €	5.200,00 €

PROPELLER Suspension

Dieser wunderbar zarte Entwurf ist ein überaus effizienter, geräuschloser Ventilator und zentrale Deckenbeleuchtung zugleich. Über ein filigranes Federdrahtgestell wird einfach ein (waschbares) elastisches Gewebe gezogen. Von innen beleuchtet, entsteht eine ebenso reizvolle wie nützliche animierte Skulptur. Und mit einer Funk-Fernbedienung regeln Sie die Drehzahl und die Drehrichtung – bequem von Ihrem Lieblingsplatz aus.

This wonderfully delicate design is an extremely efficient, silent fan and main ceiling lighting at one and the same time. A (washable) elastic fabric is just pulled over a filigree spring wire frame. Illuminated from inside, an animated sculpture emerges that is as charming as it is useful. And with a remote control you can easily regulate the number of revolutions and the direction of rotation from your favorite spot.

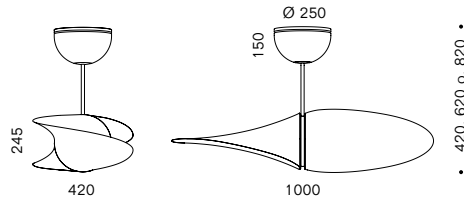

Licht light	gestreut durch den Stoffüberzug diffused through fabric cover
Leuchtmittel lamp	E27, nicht dimmbar, max. 105 W; Lieferung ohne Leuchtmittel E27, not dimmable, max. 105 W; delivery without bulb
Material material	Baldachin und Rohr: Aluminium gebürstet; Flügel: Stoffüberzug weiß aus 80% Polyamid und 20% Elasthan gespannt über Federstahl canopy and tube: aluminium brushed; wings: fabric cover white made of 80% polyamide and 20% elastane stretched over spring wire steel
Sonstiges features	Fernbedienung; Licht: An/Aus/nicht dimmbar, kompatibel mit LED-Lampen und steuerbaren LED-Lampen; Motor: Ein/Aus/Vor- bzw. Rückwärtslauf; variable Rotationsgeschwindigkeit (6-stufig mit Memory-Funktion, 25 U/Min (4 W) bis 140 U/Min.(16 W) Remote control; light: on/off/ not dimmable, compatible with LED lamps and controllable LED lamps; Motor: on/off/forward or reverse; variable rotational speed (6-stage speed control with memory function, from approx. 25 RPM (4 W) up to 140 RPM (16 W)

PROPELLER Suspension

Abbildung figure	Beschreibung description	Fassung socket	Regelung control	Leistung power	Art.-Nr. art.-no.	€ netto DE excl. VAT	€ brutto DE incl. VAT
	Länge 420 mm length 420 mm	E27	ON/OFF	max. 105 W	PR2101	1.075,63 €	1.280,00 €
	Länge 620 mm length 620 mm	E27	ON/OFF	max. 105 W	PR2102	1.075,63 €	1.280,00 €
	Länge 820 mm length 820 mm	E27	ON/OFF	max. 105 W	PR2103	1.075,63 €	1.280,00 €

REEF Suspension

Die unverwechselbaren Leuchtschirme dieser Familie bestehen aus innovativer Schaumkeramik, deren Struktur stark an Korallen erinnert. Dabei sind sie durabel, spülmaschinentauglich und verteilen das Streulicht perfekt in einem sanften Bone China-Farbtönen. Die zylindrischen Körper sind einseitig offen – so strahlen die Leuchten dieser Familie kräftig und brillant, aber völlig blendfrei.

The unmistakable lamp shades in this family are made of innovative foam ceramic, whose texture is highly reminiscent of corals. That said they are durable, dishwasher-proof and distribute the scattered light perfectly in a gentle bone china hue. The cylindrical objects are open on one side, such that the lamps in this family shine powerfully and brightly, though without any glare at all.

DESIGN PLUS



Internationaler Designpreis Baden-Württemberg 2003



reddot design award winner 2004

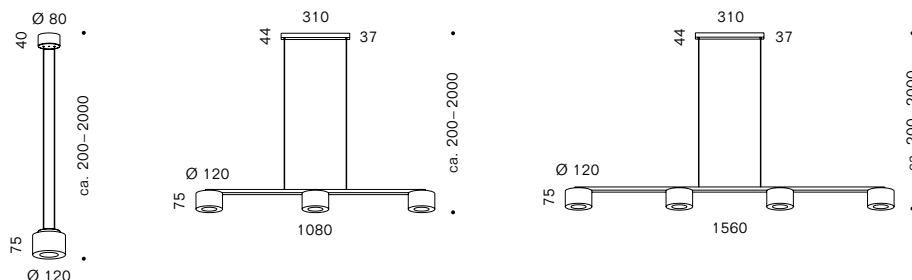

Licht
light **nach unten gerichtet, rundum diffus**
directed downwards, diffuse all around

Leuchtmittel
lamp **LED 1 x, 3 x, 4 x 8 W, CoB, CRI Ra>90, EEK/EEC F**
1 x, 3 x, 4 x G9 20 W, EEK/EEC G

Gehäuse
Housing **Aluminium poliert oder gebürstet; Schirm: Keramikschaum weiß**
aluminium polished or brushed; shade: ceramic foam white

Sonstiges
features **LED austauschbar; Schirm werkzeuglos abnehmbar und spülmaschinenfest**
LED exchangeable; shade tool-free removable and dishwasher safe

REEF Suspension 1

Abbildung figure	Beschreibung description	Leuchtmittel lamp	Regelung control	Leistung power	CCT	Lumen lumen	Art.-Nr. art.-no.	€ netto DE excl. VAT	€ brutto DE incl. VAT
●	gebürstet brushed	LED	TRIAC	8 W	2700 K	660 lm	RF2018	373,95 €	445,00 €
●	poliert polished	LED	TRIAC	8 W	2700 K	660 lm	RF2017	373,95 €	445,00 €

REEF Suspension 3

Abbildung figure	Beschreibung description	Leuchtmittel lamp	Regelung control	Leistung power	CCT	Lumen lumen	Art.-Nr. art.-no.	€ netto DE excl. VAT	€ brutto DE incl. VAT
●	gebürstet brushed	LED	TRIAC	26 W	2700 K	2820 lm	RF2021	1.134,45 €	1.350,00 €
		3 x G9	TRIAC	max. 180 W	2700 K	2940 lm	RF1006	890,76 €	1.060,00 €

REEF Suspension 4

Abbildung figure	Beschreibung description	Leuchtmittel lamp	Regelung control	Leistung power	CCT	Lumen lumen	Art.-Nr. art.-no.	€ netto DE excl. VAT	€ brutto DE incl. VAT
●	gebürstet brushed	LED	TRIAC	38 W	2700 K	3760 lm	RF2031	1.302,52 €	1.550,00 €
		4 x G9	TRIAC	max. 240 W	2700 K	3020 lm	RF1008	991,60 €	1.180,00 €

REEF Suspension 1 – Zubehör / Accessories

Baldachinprofile **Baldachine für die Montage von zwei oder drei REEF Suspension 1 an nur einem Deckenauslass finden Sie auf Seiten 198–199.**
Canopy profiles Canopies for mounting two or three REEF Suspension 1 on only one ceiling outlet can be found on pages 198–199.

☞ → 94 REEF Ceiling → 11 | REEF Wall → 115 | Baldachinprofile / Canopy profiles → 198–199

TWIN

Der Aufbau dieser eleganten Pendelleuchte ist einfach und transparent, ohne nüchtern zu wirken und verweist auf ihr Funktionsprinzip. Um den Abstand der Zwillingschirme zu verstellen, werden die Leuchtenarme einfach und leichtgängig auseinander gezogen und so den jeweiligen Bedürfnissen angepasst. Unabhängig vom Winkel der Arme bleiben die Schirme dabei stets waagrecht. Ist TWIN ganz ausgezogen, eröffnet sich zwischen den Schirmen ein Raum, der wunderbar genutzt werden kann – zum Beispiel für größere Vasen und Blumengestecke auf dem Tisch.

DESIGN PLUS



The structure of this elegant suspended lamp is straightforward and transparent, without seeming sober, and highlights its function. To alter the distance between the two shades, the arms of the lamp are simply pulled apart and thus adapted to the relevant needs. Regardless of the angle of the arms the shades stay horizontal at all times. If TWIN is fully expanded a space opens up between the two shades that can be put to optimum use, for example for large vases and bouquets on the table top.

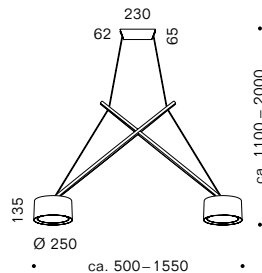

Licht light	direkt nach unten, rundum diffus directed downwards, diffuse all around
Leuchtmittel lamp	LED 2 x 11,5 W, CoB, CRI Ra>97 (R9>80), EEK/EEC F (2700 K), E (3000 K) 2 x 60 W, 2 x G9, EEK/EEC G
Material material	Leuchtenarme und Baldachin: Aluminium glanzverchromt oder schwarz seidenmatt lackiert; Schirme: Acrylglas opal weiß oder mundgeblasenes Glas opal weiß; Kabel: textillummantelt, schwarz arms and canopy: Aluminium bright chrome-plated or black lacquered; shades: Acrylic glass opal white or hand-blown translucent genuine glass; cable: textile coated black
Sonstiges features	LED wechselbar; Schirmabstand über Scherengitterprinzip stufenlos verstellbar; geeignet bis Deckenhöhe ca 3,3 m (weitere Kabellängen auf Anfrage) und Tischlängen bis 3,3 m LED exchangeable; shade spacing can be set as desired due to its snake fence structure; suitable for ceiling heights up to 3.3 m (other lengths on request) and tables up to 3.3 m long

TWIN Suspension

Abbildung figure	Beschreibung description	Leuchtmittel lamp	Regelung control	Leistung power	CCT	Lumen lumen	Art.-Nr. art.-no.	€ netto DE excl. VAT	€ brutto DE incl. VAT
●	schwarz, Acrylglas opal black, acrylic glass opal	LED	TRIAC	23 W	2700 K	2240 lm	TW1103	1.210,08 €	1.440,00 €
					3000 K	2360 lm	TW1107	1.210,08 €	1.440,00 €
		2 x G9	TRIAC	max. 120 W	2800 K	1960 lm	TW1003	899,16 €	1.070,00 €
●	schwarz, Glas opal black, glass opal	LED	TRIAC	23 W	2700 K	2240 lm	TW1303	1.420,17 €	1.690,00 €
					3000 K	2360 lm	TW1307	1.420,17 €	1.690,00 €
		2 x G9	TRIAC	max. 120 W	2800 K	1960 lm	TW1203	1.084,03 €	1.290,00 €
●	glanzverchromt, Acrylglas opal chrome-plated, acrylic glass opal	LED	TRIAC	23 W	2700 K	2240 lm	TW1101	1.302,52 €	1.550,00 €
					3000 K	2360 lm	TW1105	1.302,52 €	1.550,00 €
		2 x G9	TRIAC	max. 120 W	2800 K	1960 lm	TW1001	991,60 €	1.180,00 €
●	glanzverchromt, Glas opal chrome-plated, glass opal	LED	TRIAC	23 W	2700 K	2240 lm	TW1301	1.504,20 €	1.790,00 €
					3000 K	2360 lm	TW1305	1.504,20 €	1.790,00 €
		2 x G9	TRIAC	max. 120 W	2800 K	1960 lm	TW1201	1.168,07 €	1.390,00 €

ZOOM, ZOOM XL

Wenn man ein flexibles Scherengitter zum Kreis schließt, kann dieser seinen Durchmesser ändern – ein Effekt, den man am ehesten mit einem Kamera-ZOOM beschreiben kann. In Größe und Gestalt durchaus ein moderner Kronleuchter, wirkt ZOOM besonders imposant in den Versionen mit zwei oder drei Leuchtringen, die individuell gestuft werden können. Und für den ganz großen Auftritt gibt es ZOOM XL mit einem maximalen Durchmesser von 2.60 Metern.

If you form a circle with a flexible concertina mesh, the latter's diameter can change, an effect that can best be described with a camera zoom. In terms of size and shape by all means a modern-day chandelier, ZOOM is particularly impressive in the versions with two or three rings of lights, which can be individually layered. And for that big occasion there is ZOOM XL, which has a maximum diameter of 2.60 meters.

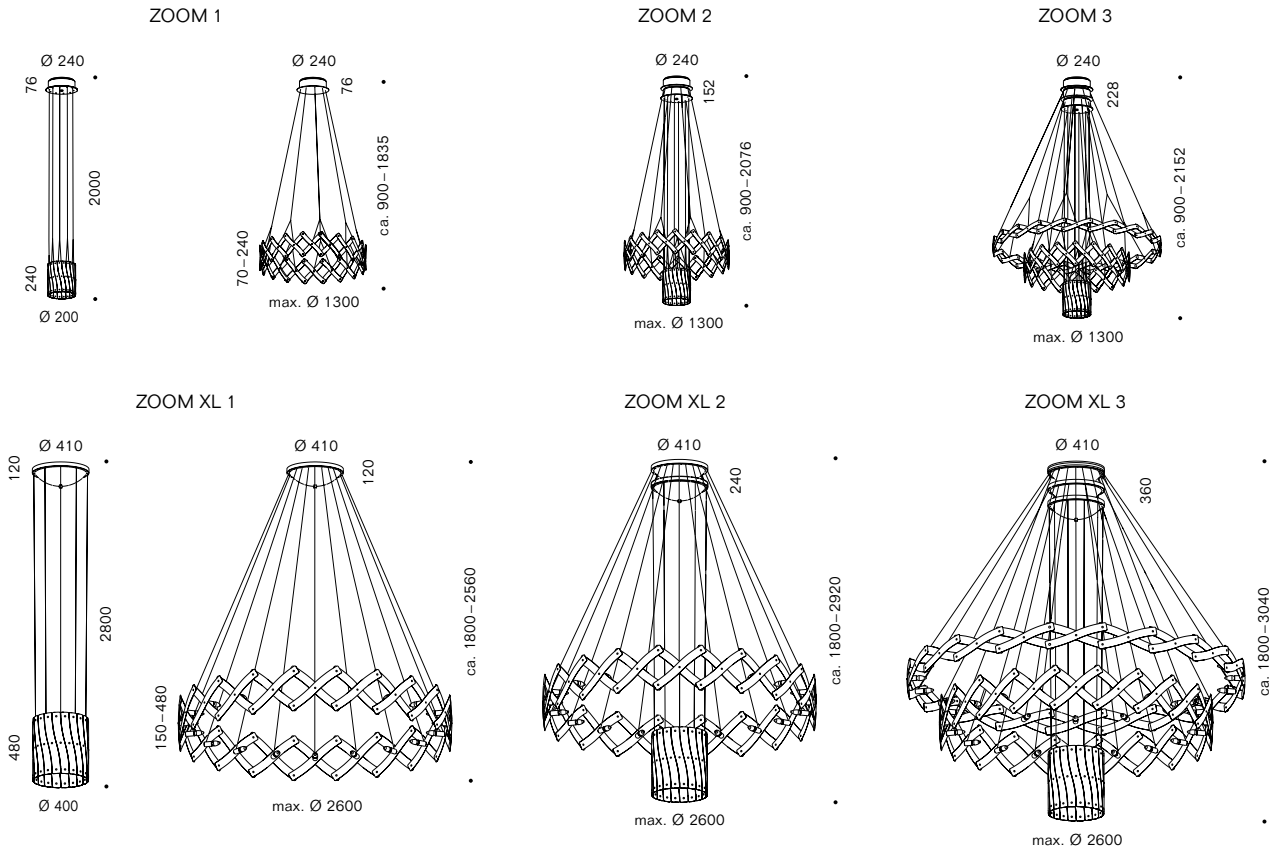

Licht light	frei abstrahlend, diffus durch Lamellen free radiating, diffused through lamellae		
Leuchtmittel lamp	ZOOM 1 LED 20 x 1,5 W, CRI Ra>90, EEK/EEC F G4 20 x 10 W, EEK/EEC G ZOOM XL 1 20 x E14 ohne Leuchtmittel/without bulbs	ZOOM 2 LED 40 x 1,5 W, CRI Ra>90, EEK/EEC F G4 40 x 10 W, EEK/EEC G ZOOM XL 2 40 x E14 ohne Leuchtmittel/without bulbs	ZOOM 3 LED 60 x 1,5 W CRI Ra>90, EEK/EEC F G4 60 x 10 W, EEK/EEC G ZOOM XL 3 60 x E14 ohne Leuchtmittel/without bulbs
Gehäuse Housing	Baldachin: Edelstahl gebürstet; Lamellen Edelstahl gebürstet, transluzente weiße Folie canopy: brushed stainless steel; lamellae: brushed stainless steel, translucent foil		
Sonstiges features	Durchmesser über Scherengitterprinzip stufenlos verstellbar. Für maximalen Durchmesser beträgt die Mindestabhängung 900 mm, bei geschlossener Leuchte. Die Leuchte steigt durch völliges Öffnen um 350 mm. Optional erhältlich: ZOOM Kristallglas Anhänger. Funkelnde Kristallketten aus Bleikristallglas die einfach in die unteren Scherengitterdrehpunkte eingehängt werden. LED und Halogen Leuchtmittel austauschbar. Diameter continuously adjustable. For maximum diameter minimum suspension is 900 mm when lamp closed. Lamp will rise 350 mm when completely opened. Optional available: ZOOM crystal glass pendants. Sparkling crystal chains of lead crystal glass which are hooked into the lower scissor lattice pivot points. LED and halogen bulbs exchangeable.		

ZOOM 1

Abbildung figure	Beschreibung description	Leuchtmittel lamp	Regelung control	Leistung power	CCT	Lumen lumen	Art.-Nr. art.-no.	€ netto DE excl. VAT	€ brutto DE incl. VAT
●	gebürstet brushed	LED	TRIAC	35 W	2700 K	2700 lm	ZO3001	1.252,10 €	1.490,00 €
			DALI	35 W	2700 K	2580 lm	ZO3011	1.336,13 €	1.590,00 €
		20 × G4	TRIAC	max. 200 W	2700 K	2600 lm	ZO1001	882,35 €	1.050,00 €

ZOOM 2

Abbildung figure	Beschreibung description	Leuchtmittel lamp	Regelung control	Leistung power	CCT	Lumen lumen	Art.-Nr. art.-no.	€ netto DE excl. VAT	€ brutto DE incl. VAT
●	gebürstet brushed	LED	TRIAC	70 W	2700 K	5400 lm	ZO3002	2.436,97 €	2.900,00 €
			DALI	70 W	2700 K	5160 lm	ZO3012	2.605,04 €	3.100,00 €
		40 × G4	TRIAC	max. 400 W	2700 K	5200 lm	ZO1003	1.680,67 €	2.000,00 €

ZOOM 3

Abbildung figure	Beschreibung description	Leuchtmittel lamp	Regelung control	Leistung power	CCT	Lumen lumen	Art.-Nr. art.-no.	€ netto DE excl. VAT	€ brutto DE incl. VAT
●	gebürstet brushed	LED	TRIAC	105 W	2700 K	8100 lm	ZO3003	3.613,45 €	4.300,00 €
			DALI	105 W	2700 K	7740 lm	ZO3013	3.865,55 €	4.600,00 €
		60 × G4	TRIAC	max. 600 W	2700 K	7800 lm	ZO1006	2.436,97 €	2.900,00 €

ZOOM XL 1

Abbildung figure	Beschreibung description	Fassung socket	Regelung control	Leistung power	Art.-Nr. art.-no.	€ netto DE excl. VAT	€ brutto DE incl. VAT
●	gebürstet brushed	20 × E14	TRIAC	max. 560 W	ZO1002	2.605,04 €	3.100,00 €

ZOOM XL 2

Abbildung figure	Beschreibung description	Fassung socket	Regelung control	Leistung power	Art.-Nr. art.-no.	€ netto DE excl. VAT	€ brutto DE incl. VAT
●	gebürstet brushed	40 × E14	TRIAC	max. 1120 W	ZO1004	5.126,05 €	6.100,00 €

ZOOM XL 3

Abbildung figure	Beschreibung description	Fassung socket	Regelung control	Leistung power	Art.-Nr. art.-no.	€ netto DE excl. VAT	€ brutto DE incl. VAT
●	gebürstet brushed	60 × E14	TRIAC	max. 1680 W	ZO1005	7.647,06 €	9.100,00 €





SUSPENSION



CAVITY Suspension • aluminium gloss finish

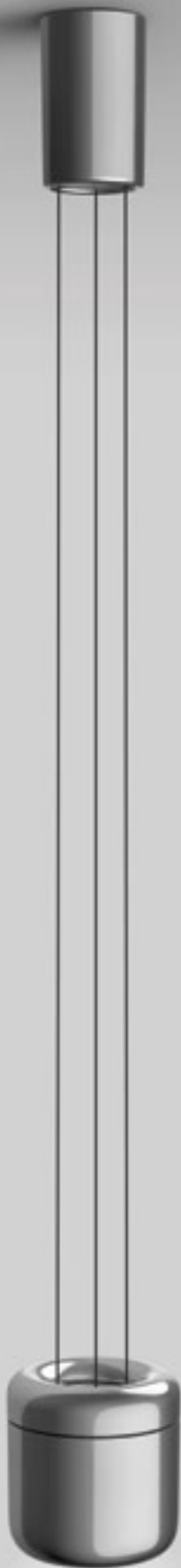

CAVITY Suspension • white



SUSPENSION

CAVITY Suspension • black



CAVITY Suspension • bronze finish









CURLING Suspension Tube M • glass new silver



CURLING Suspension Rope M • glass clear



SUSPENSION

**CURLING Suspension Rope M • glass clear
reflector: conical**



**CURLING Suspension Rope M • glass clear
reflector: cylindrical**





clear



blue



brown







Rope S · long



Rope S · short



Rope M · long



Rope M · short







white



90

silver



black





SUSPENSION







TWIN • chrome-plated



SUSPENSION









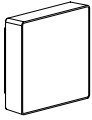

APP
S. 102



CAVITY
S. 105
new



CLUB
S. 106



CRIB
S. 107

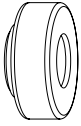

CURLING
S. 108

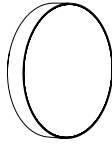

LID
S. 110

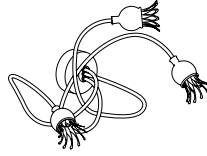

POPPY
S. 112



REEF
S. 115



REFLEX²
S. 116
new

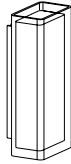

ROD
S. 117



SML
S. 118



SML²
S. 120

APP Wall

Kluges Licht, kreative Vielfalt! Ein formal schlichter LED-Leuchtquader zeigt, was in ihm steckt. Mit seiner doppellagigen Frontfläche eröffnet er größten Gestaltungsspielraum. Allein die Bandbreite der verfügbaren Standard-Fronten reicht von unterschiedlichen Strukturoberflächen über sanft mattierte Farben bis hin zu Spiegelflächen und solchen mit optischen Effekten. Wer ein Statement setzen oder eine Botschaft transportieren möchte, lässt APP mit individuellen Prints personalisieren. Hinweise, Zimmernummern, Firmenfarben... Sie haben die Wahl.



Intelligent light, creative diversity! A formally reduced LED cube shows the power within. With its double-layered front surface APP opens up immense creative scope. Even the range of standard fronts available allows numerous options from different textured structures to restrained satin colors to mirrored surfaces and those with visual effects. Those who want to make a statement or transport a message can have App personalized with individual prints. Notes, room numbers, corporate colors... it's up to you!

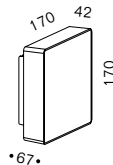

Licht
light **nach oben und unten streuend, seitlich diffus**
up- and downwards dispersed, diffuse to the sides

Leuchtmittel
lamp LED 16–22 W, CRI Ra>90, EEK/EEC E











Leuchteneinheit
light unit **Kühlkörper: Aluminium; Schirm: Polycarbonat klar**
heatsink: aluminium; shade: polycarbonate clear

Front
front **Plexiglas®, Echtglas**
Plexiglas®, genuine glass



Sonstiges
features **LED austauschbar; Fronten als Sonderausführungen in allen gängigen Plexiglas 3 mm Platten und als Foliendruck möglich; IP44 und 110 V-Varianten auf Anfrage; DALI-Varianten sind geeignet für den Einsatz in Notbeleuchtungsanlagen**
LED exchangeable; Fronts available in special versions in all common Plexiglas 3 mm panels and with foil printing; IP44 and 110 V-version on request; DALI versions are suitable for the use in emergency lighting systems

APP Wall

Abbildung figure	Beschreibung description	Leuchtmittel lamp	Regelung control	Leistung power	CCT	Lumen lumen	Art.-Nr. art.-no.	€ netto DE excl. VAT	€ brutto DE incl. VAT
	Leuchteinheit APP lighting unit APP	LED	TRIAC	16 W	2700 K	1880 lm	AP1001	281,51 €	335,00 €
					3000 K	1880 lm	AP1002	281,51 €	335,00 €
			DALI	22 W	2700 K	2690 lm	AP1005	319,33 €	380,00 €
					3000 K	2690 lm	AP1006	319,33 €	380,00 €
	Front Rippe front ribbed						AP1101	79,83 €	95,00 €
	Front Pyramide front pyramid						AP1102	79,83 €	95,00 €
	Front Wabe front honeycomb						AP1103	79,83 €	95,00 €
	Front Eiskristall front cracked ice						AP1104	79,83 €	95,00 €
	Front Weiß front white						AP1105	79,83 €	95,00 €
	Front Echtglasspiegel front genuine glass mirror						AP1106	100,84 €	120,00 €
	Front Grau front grey						AP1107	79,83 €	95,00 €
	Front fluoreszierend Grün front fluorescent green						AP1108	79,83 €	95,00 €
	Front individueller Foliendruck front individual foil print						AP1199	189,08 €	225,00 €

CAVITY Wall new available Q1 2023

CAVITY Wall setzt sanfte Lichtakzente auf der Wand und ergänzt die Produktfamilie um eine gleichseitig nach oben und unten abstrahlende Wandleuchte. Speziell konzipierte, kurvenförmige Aluminiumkörper und das vertieft darin sitzende Leuchtmittel erlauben eine freie Entfaltung des Lichts, das über die Trichterform scheinbar nach außen fließt. Unterschiedliche Beleuchtungsaufgaben können einheitlich durch Kombination der Wandleuchten mit Aufbau- und Einbaustrahlern sowie den Pendelleuchten dieser Produktfamilie gelöst werden.

CAVITY Wall sets gentle light accents on the wall and extends the product family with a wall luminaire distributing light equally upwards and downwards. Specially designed, curved aluminum bodies and the recessed illuminant within allow the light to unfold freely, seemingly flowing outwards via the funnel shaped form. Different lighting tasks can be solved consistently by combining the wall luminaires with surface-mounted and recessed spotlights and the pendant luminaires of this product family.

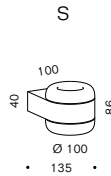

Licht
light **nach oben und unten gerichtet, seitlich abgeschirmt**
directed upwards and downwards, shielded to the sides

Leuchtmittel
lamp **LED 12 W, CoB, CRI Ra>97 (R9>80), EEK/EEC E**

Leuchteneinheit
lighting unit **Aluminium schwarz oder weiß beschichtet**
aluminum black or white coated

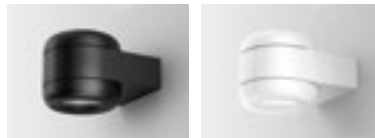

Sonstiges
features **LED austauschbar**
LED exchangeable

CAVITY Wall S

Abbildung figure	Beschreibung description	Leuchtmittel lamp	Regelung control	Leistung power	CCT	Lumen lumen	Art.-Nr. art.-no.	€ netto DE excl. VAT	€ brutto DE incl. VAT
●	schwarz black	LED	TRIAC	12 W	2700 K	1220 lm	CA2401	302,52 €	360,00 €
					3000 K	1280 lm	CA2402	302,52 €	360,00 €
			DALI	12 W	2700 K	1220 lm	CA2411	327,73 €	390,00 €
					3000 K	1280 lm	CA2412	327,73 €	390,00 €
○	weiß white	LED	TRIAC	12 W	2700 K	1220 lm	CA2405	302,52 €	360,00 €
					3000 K	1280 lm	CA2406	302,52 €	360,00 €
			DALI	12 W	2700 K	1220 lm	CA2415	327,73 €	390,00 €
					3000 K	1280 lm	CA2416	327,73 €	390,00 €

CLUB Wall

Diese Familie zeitlos klassischer Schirmeleuchten ist für den anspruchsvollen Bedarf optimiert. Statt eines Drahtgestells halten schlanke Aluminiumprofile den Schirm – und vermeiden unschöne Schattenkanten.

This family of timeless classical lamps with shades has been improved to satisfy sophisticated demands. Instead of a wire frame, slender aluminum profiles hold shade, avoiding unsightly shadow lines.

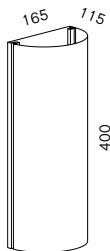

Licht light	nach oben und unten direkt, gerichtet, diffus durch Schirm directly up- and downwards, directional, diffuse through shade
Leuchtmittel lamp	LED R7s 15 W, CRI Ra>80 EEK/EEC E
Material material	Aluminium gebürstet oder schwarz lackiert; Schirm: Chintz weiß oder Melange grau aluminium brushed or black coated; shade: chintz white or melange grey
Sonstiges features	LED-Retrofit in Lieferung enthalten LED-Retrofit Included in delivery

CLUB Wall

Abbildung figure	Beschreibung description	Leuchtmittel lamp	Regelung control	Leistung power	CCT	Lumen lumen	Art.-Nr. art.-no.	€ netto DE excl. VAT	€ brutto DE incl. VAT
	gebürstet, Chintz weiß brushed, Chintz white	LED	TRIAC	15 W	2700 K	2000 lm	CL1075	243,70 €	290,00 €
	schwarz, Chintz weiß black, Chintz white	LED	TRIAC	15 W	2700 K	2000 lm	CL1065	243,70 €	290,00 €
	gebürstet, Melange grau brushed, Melange grey	LED	TRIAC	15 W	2700 K	2000 lm	CL2131	243,70 €	290,00 €
	schwarz, Melange grau black, Melange grey	LED	TRIAC	15 W	2700 K	2000 lm	CL2132	243,70 €	290,00 €

CRIB Wall

Im ausgeschalteten Zustand ist CRIB ein formal extrem reduziertes Wandobjekt aus einem schlichten Metallkörper und einer transparenten Glasfläche. Erst im eingeschalteten Zustand offenbart sich die Raffinesse des Glaselements, über dessen polierte Kante das LED-Licht eingespeist wird: Eine feine, speziell behandelte Echtglasscheibe lenkt das Licht gleichmäßig nach oben und unten. CRIB kann umgedreht, horizontal oder vertikal montiert werden und sorgt als Solitär oder in der Reihung für eine magische Lichtwirkung in minimalistischer Form.



When switched off, CRIB is a formally extremely reduced wall object made up of a simple metal body and a transparent glass surface. It is only when switched on that the sophistication of the glass element is revealed, as LED light is supplied via its polished edge: A delicate, specially treated pane of glass distributes the light evenly upwards and downwards. CRIB may be installed upside down, vertically or horizontally, and with its minimalist form creates a magical light effect both when used as a single luminaire or in a row.

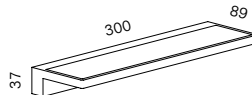

Licht
light **nach oben und unten gestreut**
upwards and downwards diffuse

Leuchtmittel
lamp LED 12 W, CRI Ra>90, R9>50, EEK/EEC E

Material
material **Gehäuse: Zink schwarz oder weiß beschichtet, Edelstahl finish oder Chrom finish;**
Lampenabdeckung: Optiwhite Echtglas mit Mikrostruktur
housing: zinc black or white coated, stainless steel finish or chrome finish;
lamp cover: optiwhite glass with microstructure

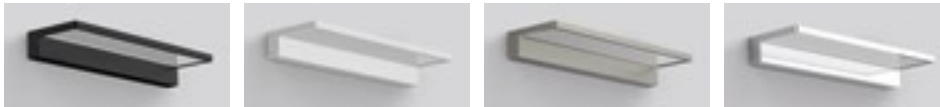

Sonstiges
features **LED austauschbar; kann als Up- oder Downlight montiert werden; IP44 Varianten sind nur für Innenräume geeignet**
LED exchangeable; can be mounted upwards or downwards; IP44 variants are only suitable for indoor use

CRIB Wall

Abbildung figure	Beschreibung description	Leuchtmittel lamp	Regelung control	Leistung power	CCT	Lumen lumen	Art.-Nr. art.-no.	€ netto DE excl. VAT	€ brutto DE incl. VAT
●	schwarz black	LED	TRIAC	12 W	2700 K	1350 lm	CR1001	369,75 €	440,00 €
○	weiß white	LED	TRIAC	12 W	2700 K	1350 lm	CR1002	369,75 €	440,00 €
●	Edelstahl finish stainless steel finish	LED	TRIAC	12 W	2700 K	1350 lm	CR1003	411,76 €	490,00 €
●	Chrom finish chrome finish	LED	TRIAC	12 W	2700 K	1350 lm	CR1005	411,76 €	490,00 €

CRIB Wall IP44

Abbildung figure	Beschreibung description	Leuchtmittel lamp	Regelung control	Leistung power	CCT	Lumen lumen	Art.-Nr. art.-no.	€ netto DE excl. VAT	€ brutto DE incl. VAT
●	schwarz black	LED	TRIAC	12 W	2700 K	1350 lm	CR1101	403,36 €	480,00 €
○	weiß white	LED	TRIAC	12 W	2700 K	1350 lm	CR1102	403,36 €	480,00 €
●	Edelstahl finish stainless steel finish	LED	TRIAC	12 W	2700 K	1350 lm	CR1103	453,78 €	540,00 €
●	Chrom finish chrome finish	LED	TRIAC	12 W	2700 K	1350 lm	CR1104	453,78 €	540,00 €

CURLING Wall

CURLING Wall ergänzt die Produktfamilie um eine Wandleuchte, die für ein atmosphärisches Rundumlicht sorgt und so zum prägnanten Lichtobjekt wird. Ein spezieller Diffusor erzeugt ein dekoratives Lichtspiel der mundgeblasenen Glas- und handpolierten Metalloberflächen und macht die Leuchte zugleich blendfrei. Versionen mit Acrylglasschirm in kantiger Ästhetik erweitert das Einsatzspektrum von CURLING und ermöglichen einen optimalen Einsatz in Schulen, Kindergärten, Treppenhäusern und anderen Verkehrswegen im halböffentlichen oder öffentlichen Raum.

INNOVATIONSPREIS
ARCHITEKTUR +
TECHNIK
2020 AUSZEICHNUNG

CURLING Wall extends the product family to include a wall-mounted luminaire that delivers atmospheric all-round light and thus functions as a striking light sculpture. A special diffuser creates decoratively playful light thanks to the handblown glass and hand-polished metal surfaces, and also ensures the luminaire is glare-free. Versions with acrylic glass shade in angular aesthetics expand CURLING's range of applications and enable optimal use in schools, kindergartens, stairwells and other paths in semi-public and public spaces.

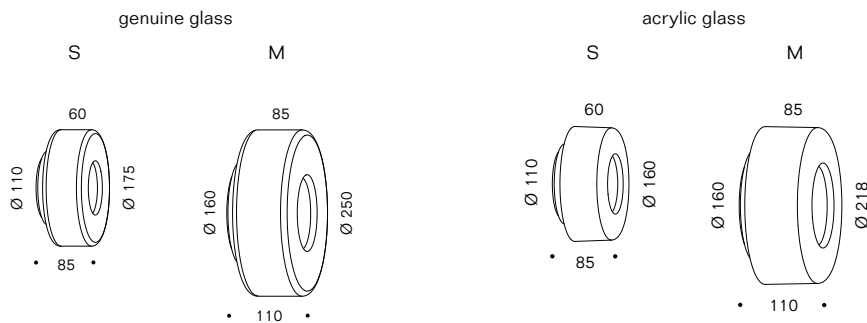

Leuchtmittel
lamp LED 11–20 W, CoB, CRI Ra>97 (R9>80), EEK/EEC F (2700 K, 3000 K), G (1800–3000 K D2W)

Leuchteneinheit
Lighting unit Aluminium hochglanzpoliert
aluminum highly polished

Schirm
shade mundgeblasenes Glas klar oder metallisiert
Diffusor: Polycarbonat, PMMA
hand-blown glass clear or metallised
diffuser: polycarbonate, PMMA

Acrylglas klar
Reflektor: Polycarbonat, PMMA
Acrylic glass clear
reflector: polycarbonate, PMMA

Ausführungen
versions



Glasschirm klar
Licht: nach vorne diffus,
rundum abstrahlend
glass shade clear
light: diffuse to the front,
distributed all around



Acrylglaschirm klar
Licht: nach vorne diffus,
rundum abstrahlend
acrylic glass shade clear
light: diffuse to the front,
distributed all around







Glasschirm neusilber
Licht: nach vorne diffus,
rundum abstrahlend
glass shade new silver
light: diffuse to the front,
distributed all around





Sonstiges
features LED wechselbar, werkzeuglose Schirmmontage; 110 V-Varianten auf Anfrage;
DALI-Varianten für den Einsatz in Notbeleuchtungsanlagen auf Anfrage
LED exchangeable, shade tool-free mountable; 110 V versions on request;
DALI versions for the use in emergency lighting systems on request

CURLING ist ein modularer Artikel. Bitte jeweils Leuchteneinheit und Glasschirm zusammen bestellen.
CURLING is a modular article. Please order the lighting unit and glass shade together.

CURLING Wall S

Abbildung figure	Beschreibung description	Leuchtmittel lamp	Regelung control	Leistung power	CCT	Lumen lumen	Art.-Nr. art.-no.	€ netto DE excl. VAT	€ brutto DE incl. VAT
	Leuchteneinheit S lighting unit S	LED	TRIAC	11 W	2700 K	1130 lm	LE015701	180,67 €	215,00 €
					3000 K	1180 lm	LE015702	180,67 €	215,00 €
					1800 K–3000 K D2W	870 lm	LE015703	214,29 €	255,00 €
			DALI	11 W	2700 K	1130 lm	LE015730	205,88 €	245,00 €
					3000 K	1180 lm	LE015731	205,88 €	245,00 €
					1800 K–3000 K D2W	870 lm	LE015732	239,50 €	285,00 €
	Glas S klar glass S clear						CU011212	201,68 €	240,00 €
	Glasschirm S neusilber glass shade S new silver						CU011218	268,91 €	320,00 €
	Acrylglas S klar acrylic glass S clear						CU011220	100,84 €	120,00 €

CURLING Wall M

Abbildung figure	Beschreibung description	Leuchtmittel lamp	Regelung control	Leistung power	CCT	Lumen lumen	Art.-Nr. art.-no.	€ netto DE excl. VAT	€ brutto DE incl. VAT
	Leuchteneinheit M lighting unit M	LED	TRIAC	20 W	2700 K	1910 lm	LE015710	239,50 €	285,00 €
					3000 K	2010 lm	LE015711	239,50 €	285,00 €
					1800 K–3000 K D2W	1540 lm	LE015712	273,11 €	325,00 €
			DALI 1–10 V	20 W	2700 K	1910 lm	LE015713	264,71 €	315,00 €
					3000 K	2010 lm	LE015714	264,71 €	315,00 €
					1800 K–3000 K D2W	1540 lm	LE015715	298,32 €	355,00 €
	Glas M klar glass M clear						CU011209	235,29 €	280,00 €
	Glasschirm M neusilber glass shade M new silver						CU011219	319,33 €	380,00 €
	Acrylglas M klar acrylic glass M clear						CU011223	126,05 €	150,00 €

CURLING Wall M – Zubehör / Accessories

Optiken
optics

Einfach austauschbare Optiken zur Bestimmung der Lichtverteilung von CURLING Wall M finden Sie auf Seite 201.
Easily replaceable optics to define the light distribution of CURLING Wall M, see page 201.

LID Wall

Bei Tag ist LID ein dezentes Designobjekt. Sobald man LID einschaltet, verwandelt sie sich in sphärisches Licht. Einen besonderen Akzent setzt eine feine Lichtaura, durch die sich die kreisrunde Scheibe von dem sie umgebenden Lichtschein abhebt. LID löst sich optisch vom Hintergrund und entfaltet eine angenehme, ruhige Lichtstimmung.



During the day LID is a discreet design object but as soon as LID is turned on, it morphs into spherical light. The fine aura of light that emanates through the circular disc is particularly eye-catching and sets it off from the surrounding shining light. LID stands out from the backgrounds and contributes to a pleasant, calm and light mood.

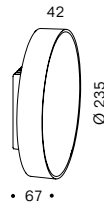

Licht light	rundum gleichmäßig abstrahlend radiating evenly right round
-----------------------	---





Leuchtmittel lamp	LED 16–22 W, CRI Ra>90, EEK/EEC E
-----------------------------	-----------------------------------

Material material	Kühlkörper: Aluminium, Schirm: Plexiglas® transparent; Front: Glas opal, Spiegelglas, Aluminium silber eloxiert, Aluminium champagner eloxiert cooling unit: aluminium; housing: transparent Plexiglas®; front: opal glass, mirror glass, aluminium silver or gold anodized
-----------------------------	--







Sonstiges features	LED austauschbar LED exchangeable
------------------------------	---

LID Wall

Abbildung figure	Beschreibung description	Leuchtmittel lamp	Regelung control	Leistung power	CCT	Lumen lumen	Art.-Nr. art.-no.	€ netto DE excl. VAT	€ brutto DE incl. VAT
	Leuchteneinheit LID lighting unit LID	LED	TRIAC	16 W	2700 K	1880 lm	LD1001	306,72 €	365,00 €
					3000 K	1880 lm	LD1002	306,72 €	365,00 €
			DALI	22 W	2700 K	2690 lm	LD1005	340,34 €	405,00 €
					3000 K	2690 lm	LD1006	340,34 €	405,00 €
	Front Aluminium champagner eloxiert front aluminium champagne anodized						LD1103	96,64 €	115,00 €
	Front Aluminium silber eloxiert front aluminium silver anodized						LD1104	96,64 €	115,00 €
	Front Echtglas opal front genuine glass opal						LD1101	134,45 €	160,00 €
	Front Spiegel front genuine glass mirror						LD1102	134,45 €	160,00 €

LID Wall IP44

Abbildung figure	Beschreibung description	Leuchtmittel lamp	Regelung control	Leistung power	CCT	Lumen lumen	Art.-Nr. art.-no.	€ netto DE excl. VAT	€ brutto DE incl. VAT
	Leuchteneinheit LID IP44 lighting unit LID IP44	LED	TRIAC	16 W	2700 K	1880 lm	LD1201	340,34 €	405,00 €
					3000 K	1880 lm	LD1202	340,34 €	405,00 €
			DALI	22 W	2700 K	2690 lm	LD1205	365,55 €	435,00 €
					3000 K	2690 lm	LD1206	365,55 €	435,00 €
	IP44 Front Aluminium champagner eloxiert front aluminium champagne anodized						LD1303	117,65 €	140,00 €
	IP44 Front Aluminium silber eloxiert front aluminium silver anodized						LD1304	117,65 €	140,00 €
	IP44 Front Echtglas opal front genuine glass opal						LD1301	151,26 €	180,00 €
	IP44 Front Spiegel front genuine glass mirror						LD1302	151,26 €	180,00 €

POPPY Wall

Werden die „Mohnblüten“ dieser Familie durch Einschalten geweckt, öffnen sich ihre Schirme ganz allmählich: die feinen Blätter sind aus Bimetall und dehnen sich durch Erwärmung aus. Alle Varianten können nach Belieben umgestaltet werden. Der flexible, textilmantelte Schlauch lässt sich immer neu biegen – zur Änderung der Lichtrichtung, oder einfach weil Ihnen danach ist. Die mundgeblasenen Glaskapseln sind erhältlich in den Farben keramik, rubinrot oder violett.

When the “poppy flowers” in this family are woken by the lamp being switched on, their shades open very gradually: the delicate leaves are bi-metallic and expand when heated. All the versions can be reshaped as desired. The flexible, textile-coated stem can be bent at will, to change the direction of the light, or because you just feel like it. The hand-blown glass capsules are available in ceramic, ruby red or violet.

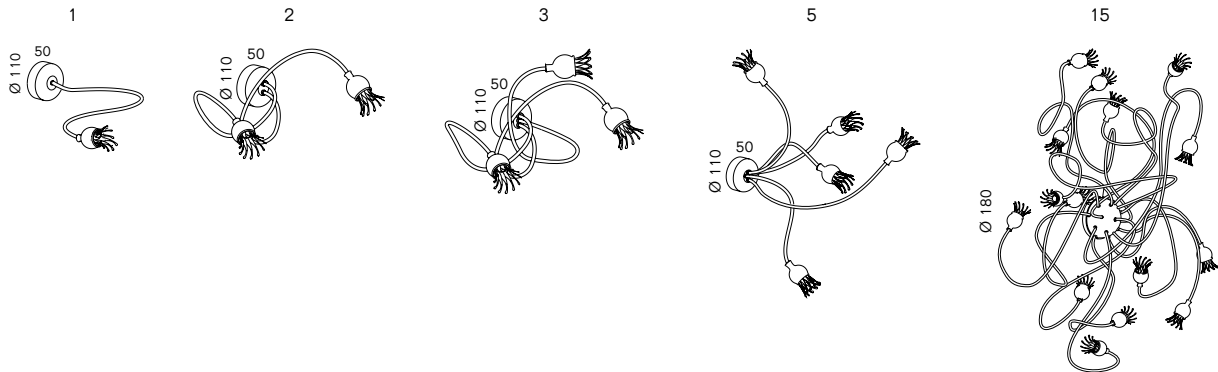







Licht light	nach vorne gerichtet, seitlich abgeschirmt directed forward, shielded to the sides
Leuchtmittel lamp	POPPY Wall 1/2/3: 1×/2×/3×G4 35 W, 12 V, EEK/EEC G POPPY Wall 5/15: 5×/15×G4 20 W, 12 V, EEK/EEC G
Größen sizes	1 bis 5 Arme: Länge der Arme 75 cm, 15 Arme: Länge der Arme 75 oder 150 cm 1 to 5 arms: length of arms 75 cm, 15 arms: length of arms 75 cm or 150 cm
Material material	Arme, flexibel: Aluminium, textilmantelt beige oder schwarz; Glasschirme: mundgeblasenes Glas keramik, rubinrot oder violett; Lamellen: Bimetall; Baldachin: 1–5 Arme Edelstahl, poliert; 15 Arme: Edelstahl gebürstet arms, flexible: textile coated aluminium tube in beige or black; glass shade: hand-blown glass in ceramic, ruby red or violet; lamellae: bimetal; canopy: 1–5 arms stainless steel, polished; 15 arms: stainless steel, brushed
Sonstiges features	Leuchtmittel in Lieferung enthalten; Reflektor-Lamellen öffnen sich nach ca. 2 Minuten Betriebszeit; Leuchte kann auch als Deckenleuchte montiert werden lamps included in delivery; lamellae open within approx. 2 minutes after switching on luminaire; luminaire can also be mounted as ceiling luminaire







POPPY Wall 1

Abbildung figure	Beschreibung description	Fassung socket	Regelung control	Leistung power	Art.-Nr. art.-no.	€ netto DE excl. VAT	€ brutto DE incl. VAT
	1 Arm schwarz, Schirm keramik 1 arm black, shade ceramic	G4	ON/OFF	max. 35 W	PO1025	394,96 €	470,00 €
	1 Arm schwarz, Schirm rubinrot 1 arm black, shade ruby red	G4	ON/OFF	max. 35 W	PO1026	394,96 €	470,00 €
	1 Arm schwarz, Schirm violett 1 arm black, shade violet	G4	ON/OFF	max. 35 W	PO1027	394,96 €	470,00 €
	1 Arm beige, Schirm keramik 1 arm beige shade ceramic	G4	ON/OFF	max. 35 W	PO1028	394,96 €	470,00 €
	1 Arm beige, Schirm rubinrot 1 arm beige shade ruby red	G4	ON/OFF	max. 35 W	PO1029	394,96 €	470,00 €
	1 Arm beige, Schirm violett 1 arm beige shade violet	G4	ON/OFF	max. 35 W	PO1030	394,96 €	470,00 €







POPPY Wall 2

Abbildung figure	Beschreibung description	Fassung socket	Regelung control	Leistung power	Art.-Nr. art.-no.	€ netto DE excl. VAT	€ brutto DE incl. VAT
	2 Arme schwarz, Schirme keramik 2 arms black, shades ceramic	2 × G4	ON/OFF	max. 70 W	PO1031	495,80 €	590,00 €
	2 Arme schwarz, Schirme rubinrot 2 arms black, shades ruby red	2 × G4	ON/OFF	max. 70 W	PO1032	495,80 €	590,00 €
	2 Arme schwarz, Schirme violett 2 arms black, shades violet	2 × G4	ON/OFF	max. 70 W	PO1033	495,80 €	590,00 €
	2 Arme beige, Schirme keramik 2 arms beige shades ceramic	2 × G4	ON/OFF	max. 70 W	PO1034	495,80 €	590,00 €
	2 Arme beige, Schirme rubinrot 2 arms beige shades ruby red	2 × G4	ON/OFF	max. 70 W	PO1035	495,80 €	590,00 €
	2 Arme beige, Schirme violett 2 arms beige shades violet	2 × G4	ON/OFF	max. 70 W	PO1036	495,80 €	590,00 €







POPPY Wall 3

Abbildung figure	Beschreibung description	Fassung socket	Regelung control	Leistung power	Art.-Nr. art.-no.	€ netto DE excl. VAT	€ brutto DE incl. VAT
	3 Arme schwarz, Schirme keramik 3 arms black, shades ceramic	3 × G4	ON/OFF	max. 105 W	PO1037	596,64 €	710,00 €
	3 Arme schwarz, Schirme rubinrot 3 arms black, shades ruby red	3 × G4	ON/OFF	max. 105 W	PO1038	596,64 €	710,00 €
	3 Arme schwarz, Schirme violett 3 arms black, shades violet	3 × G4	ON/OFF	max. 105 W	PO1039	596,64 €	710,00 €
	3 Arme beige, Schirme keramik 3 arms beige shades ceramic	3 × G4	ON/OFF	max. 105 W	PO1040	596,64 €	710,00 €
	3 Arme beige, Schirme rubinrot 3 arms beige shades ruby red	3 × G4	ON/OFF	max. 105 W	PO1041	596,64 €	710,00 €
	3 Arme beige, Schirme violett 3 arms beige shades violet	3 × G4	ON/OFF	max. 105 W	PO1042	596,64 €	710,00 €

POPPY Wall 5

Abbildung figure	Beschreibung description	Fassung socket	Regelung control	Leistung power	Art.-Nr. art.-no.	€ netto DE excl. VAT	€ brutto DE incl. VAT
	5 Arme schwarz, Schirme keramik 5 arms black, shades ceramic	5 × G4	ON/OFF	max. 100 W	PO1043	773,11 €	920,00 €
	5 Arme schwarz, Schirme rubinrot 5 arms black, shades ruby red	5 × G4	ON/OFF	max. 100 W	PO1044	773,11 €	920,00 €
	5 Arme schwarz, Schirme violett 5 arms black, shades violet	5 × G4	ON/OFF	max. 100 W	PO1045	773,11 €	920,00 €
	5 Arme beige, Schirme keramik 5 arms beige shades ceramic	5 × G4	ON/OFF	max. 100 W	PO1046	773,11 €	920,00 €
	5 Arme beige, Schirme rubinrot 5 arms beige shades ruby red	5 × G4	ON/OFF	max. 100 W	PO1047	773,11 €	920,00 €
	5 Arme beige, Schirme violett 5 arms beige shades violet	5 × G4	ON/OFF	max. 100 W	PO1048	773,11 €	920,00 €

POPPY Wall 15

Abbildung figure	Beschreibung description	Fassung socket	Regelung control	Leistung power	Art.-Nr. art.-no.	€ netto DE excl. VAT	€ brutto DE incl. VAT
	15 Arme 75 cm schwarz, Schirme keramik 15 arms 75 cm black, shades ceramic	15 × G4	ON/OFF	max. 300 W	PO1007	1.764,71 €	2.100,00 €
	15 Arme 150 cm schwarz, Schirme keramik 15 arms 150 cm black, shades ceramic	15 × G4	ON/OFF	max. 300 W	PO1010	1.848,74 €	2.200,00 €
	15 Arme 75 cm schwarz, Schirme rubinrot 15 arms 75 cm black, shades ruby red	15 × G4	ON/OFF	max. 300 W	PO1008	1.764,71 €	2.100,00 €
	15 Arme 150 cm schwarz, Schirme rubinrot arms 150 cm black, shades ruby red	15 × G4	ON/OFF	max. 300 W	PO1011	1.848,74 €	2.200,00 €
	15 Arme 75 cm schwarz, Schirme violett 15 arms 75 cm black, shades violet	15 × G4	ON/OFF	max. 300 W	PO1009	1.764,71 €	2.100,00 €
	15 Arme 150 cm schwarz, Schirme violett 15 arms 150 cm black, shades violet	15 × G4	ON/OFF	max. 300 W	PO1012	1.848,74 €	2.200,00 €
	15 Arme 75 cm beige, Schirme keramik 15 arms 75 cm beige, shades ceramic	15 × G4	ON/OFF	max. 300 W	PO1013	1.764,71 €	2.100,00 €
	15 Arme 150 cm beige, Schirme keramik 15 arms 150 cm beige, shades ceramic	15 × G4	ON/OFF	max. 300 W	PO1016	1.848,74 €	2.200,00 €
	15 Arme 75 cm beige, Schirme rubinrot 15 arms 75 cm beige, shades ruby red	15 × G4	ON/OFF	max. 300 W	PO1014	1.764,71 €	2.100,00 €
	15 Arme 150 cm beige, Schirme rubinrot 15 arms 150 cm beige, shades ruby red	15 × G4	ON/OFF	max. 300 W	PO1017	1.848,74 €	2.200,00 €
	15 Arme 75 cm beige, Schirme violett 15 arms 75 cm beige, shades violet	15 × G4	ON/OFF	max. 300 W	PO1015	1.764,71 €	2.100,00 €
	15 Arme 150 cm beige, Schirme violett 15 arms 150 cm beige, shades violet	15 × G4	ON/OFF	max. 300 W	PO1018	1.848,74 €	2.200,00 €

REEF Wall

Die unverwechselbaren Leuchtschirme dieser Familie bestehen aus innovativer Schaumkeramik, deren Struktur stark an Korallen erinnert. Dabei sind sie durabel, spülmaschinentauglich und verteilen das Streulicht perfekt in einem sanften Bone China-Farbton. Die zylindrischen Körper sind einseitig offen – so strahlen die Leuchten dieser Familie kräftig und brillant, aber völlig blendfrei.

The unmistakable lamp shades in this family are made of innovative foam ceramic, whose texture is highly reminiscent of corals. That said they are durable, dishwasher-proof and distribute the scattered light perfectly in a gentle bone china hue. The cylindrical objects are open on one side, such that the lamps in this family shine powerfully and brightly, though without any glare at all.



reddot design award
winner 2004

DESIGN PLUS

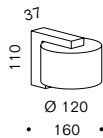

downlight

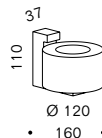

uplight

Licht light	nach unten gerichtet, rundum diffus directed downwards, diffuse all around
Leuchtmittel lamp	LED 8 W, CoB, CRI Ra>97, EEK/EEC F G9 max. 60 W, EEK/EEC G
Gehäuse Housing	Aluminium poliert oder gebürstet; Leuchtschirm: Keramikschaum weiß aluminium polished or brushed; shade: ceramic foam white
Sonstiges features	Schirm werkzeuglos abnehmbar und spülmaschinenfest; LED austauschbar; kann als Up- oder Downlight montiert werden shade tool-free removable and dishwasher safe; LED exchangeable; can be mounted upwards or downwards

REEF Wall

Abbildung figure	Beschreibung description	Leuchtmittel lamp	Regelung control	Leistung power	CCT	Lumen lumen	Art.-Nr. art.-no.	€ netto DE excl. VAT	€ brutto DE incl. VAT
●	gebürstet brushed	LED	TRIAC	8 W	2700 K	790 lm	RF2057	386,55 €	460,00 €
		G9	TRIAC	max. 60 W	2700 K	740 lm	RF1002	289,92 €	345,00 €
●	poliert polished	LED	TRIAC	8 W	2700 K	790 lm	RF2058	411,76 €	490,00 €
		G9	TRIAC	max. 60 W	2700 K	740 lm	RF1001	310,92 €	370,00 €

REFLEX² Wall reduziert die Formensprache der Produktfamilie auf das Wesentliche und komplettiert sie mit einer extrem flachen Wandleuchte. REFLEX² Wall greift als Uplight das Prinzip der indirekten Beleuchtung auf, die intensives, weiches Licht über Decke und Wand in den Raum strahlt und so für ein absolut blendfreies Licht im Büro, in Privaträumen oder im Objektbereich sorgt.

REFLEX² Wall reduces the design language of the product family to the essentials and completes it with an extremely flat wall luminaire. As an uplight, REFLEX² Wall picks up on the principle of indirect lighting, emitting intense, soft light into the room via the ceiling and wall, thus providing absolutely glare-free light for offices, private rooms and more extensive projects.

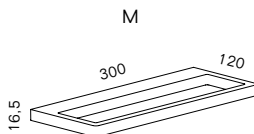

Licht light	nach oben oder unten gerichtet, indirekt über Wand und Decke directed upwards, indirectly via wall and ceiling
Leuchtmittel lamp	LED 12 W, CRI Ra>90 (R9>50), EEK/EEC E
Gehäuse housing	Aluminium schwarz oder weiß beschichtet aluminium black or white coated
Material material	Leuchtmittelabdeckung: Flachglas satinée lamp cover: glass semigloss
Sonstiges features	LED austauschbar; kann als Up- oder Downlight montiert werden LED exchangeable; can be mounted upwards or downwards

REFLEX² Wall M

Abbildung figure	Beschreibung description	Leuchtmittel lamp	Regelung control	Leistung power	CCT	Lumen lumen	Art.-Nr. art.-no.	€ netto DE excl. VAT	€ brutto DE incl. VAT
●	schwarz black	LED	TRIAC	12 W	2700 K	1420 lm	RE4001	319,33 €	380,00 €
					3000 K	1470 lm	RE4003	319,33 €	380,00 €
○	weiß white	LED	TRIAC	12 W	2700 K	1420 lm	RE4002	319,33 €	380,00 €
					3000 K	1470 lm	RE4004	319,33 €	380,00 €

REFLEX² Wall M – Zubehör / Accessories

Wandabdeckungen Zur Abdeckung von z. B. Anschlussdosen finden Sie passende Wandabdeckungen auf Seite 203.
Wall covers To cover e.g. junction boxes wall matching covers can be found on page 203.

ROD Wall

Mit einem reduzierten Glaskörper in einem abgerundeten, kubischen Glasprofil erhält ROD die Anmutung einer minimalistischen Wandvitrine. Aufgrund ihres leichten Wandabstands wird sie zur schwebenden, fast schon architektonischen vertikalen Struktur. Mit einem illuminierten Innenkörper und den unterschiedlichen Innenschirmen lassen sich verschiedene Lichtszenarien schaffen.



With its reduced glass body in a rounded, cubic glass profile, ROD appears like a minimalist display cabinet mounted on the wall. The slight gap between the luminaire and the wall turns it into a floating, almost architectural vertical structure. Various lighting scenarios may be created with the illuminated inner body and the very different inner shades.



Licht
light **direkt nach oben und unten, nach vorne diffus oder abgeschirmt**
directed upwards and downwards, forwards diffuse or shielded

Leuchtmittel
lamp LED 27 W, CRI Ra>90, R9>50, EEK/EEC F

Gehäuse
Housing **Glasschirm: Borosilikatglasrohr; Gehäuse: Aluminium weiß beschichtet**
glass shade: borosilicate glass tube; body: aluminium white coated

Innenschirm
inner shade **Acrylglas opal, Aluminium glanzverchromt oder gold eloxiert**
acrylic satinée opal, aluminium chrome plated or gold anodized



Sonstiges
features **LED austauschbar; weitere Ausführungen (CCT/CRI) und andere Oberflächen auf Anfrage erhältlich.**
LED exchangeable; other versions (CCT/CRI) and different coatings available on request.

ROD Wall

Abbildung figure	Beschreibung description	Leuchtmittel lamp	Regelung control	Leistung power	CCT	Lumen lumen	Art.-Nr. art.-no.	€ netto DE excl. VAT	€ brutto DE incl. VAT
○	opal opal	LED	TRIAC 0–10 V	27 W	2700 K	3180 lm	RD1001	470,59 €	560,00 €
			DALI	27 W	2700 K	3180 lm	RD1009	495,80 €	590,00 €
●	glanzverchromt chrome plated	LED	TRIAC 0–10 V	27 W	2700 K	3180 lm	RD1002	470,59 €	560,00 €
			DALI	27 W	2700 K	3180 lm	RD1010	495,80 €	590,00 €
●	gold eloxiert gold anodized	LED	TRIAC 0–10 V	27 W	2700 K	3180 lm	RD1018	470,59 €	560,00 €
			DALI	27 W	2700 K	3180 lm	RD1021	495,80 €	590,00 €

SML Wall

Als Baukastensystem konzipiert, bietet das SML-Programm eine Fülle an Einsatzmöglichkeiten. Konsequente Gestaltung hat seine Abmessungen auf das Minimum reduziert: 25 mm Bauhöhe. Die für oben und unten frei wählbaren unterschiedlichen Leuchtmittelabdeckungen ermöglichen eine individuelle Lichtlenkung – symmetrisch nach oben und unten streuend oder zu einer Seite abgeblendet. So können repräsentative Büros oder Wohnungen in einer einheitlichen Formensprache beleuchtet werden, ohne dabei auf unterschiedliche Lichtqualitäten verzichten zu müssen.

Conceived as a modular system, the SML range can be used for a variety of purposes. A consistent design has pared its dimensions down to a minimum: 25 mm in height. The different illuminant covers, which can be chosen freely for top and bottom, allow the light to be directed individually – symmetrically scattering upward and downward or shielded to one side. This way, for example, prestigious offices and apartments can be illuminated in a uniform formal language, without having to do without differing qualities of light.

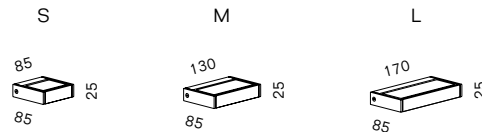

Licht light	Abhängig von gewählter Leuchtmittelabdeckung symmetrisch nach oben und unten gestreut oder zu einer Seite gestreut, zur anderen abgeblendet depending on the chosen illuminant covers symmetrical scattering upward and downward or scattered to one side, dimmed to the other
-----------------------	--

Leuchtmittel lamp	S: 60 W G9, EEK/EEC G M: 120 W R7s, EEK/EEC G L: 160 W R7s, EEK/EEC G
-----------------------------	---





Material material	Aluminium eloxiert silber oder Aluminium glanzverchromt, Leuchtmittelabdeckungen: Keramikglas aluminum anodized silver or aluminum chrome-plated, bulb covers: ceramic glass
-----------------------------	--

SML Wall – Zubehör / Accessories





Wandabdeckungen Wall covers	Zur Abdeckung von z. B. Anschlussdosen finden Sie passende Wandabdeckungen auf Seite 203. To cover e.g. junction boxes wall matching covers can be found on page 203.
---------------------------------------	---







SML Wall S

Abbildung figure	Beschreibung description	Fassung socket	Regelung control	Leistung power	Art.-Nr. art.-no.	€ netto DE excl. VAT	€ brutto DE incl. VAT
	silber, satinée/satinée silver, satinée/satinée	G9	TRIAC	max. 60 W	SM1172	243,70 €	290,00 €
	silber, satinée/Raster silver, satinée/raster	G9	TRIAC	max. 60 W	SM1199	243,70 €	290,00 €
	glanzverchromt, satinée/satinée chrome plated, satinée/satinée	G9	TRIAC	max. 60 W	SM3172	273,11 €	325,00 €
	glanzverchromt, satinée/Raster chrome plated, satinée/raster	G9	TRIAC	max. 60 W	SM3199	273,11 €	325,00 €

SML Wall M

Abbildung figure	Beschreibung description	Fassung socket	Regelung control	Leistung power	Art.-Nr. art.-no.	€ netto DE excl. VAT	€ brutto DE incl. VAT
	silber, satinée/satinée silver, satinée/satinée	R7s	TRIAC	max. 120 W	SM1173	260,50 €	310,00 €
	silber, satinée/Raster silver, satinée/raster	R7s	TRIAC	max. 120 W	SM1198	260,50 €	310,00 €
	glanzverchromt, satinée/satinée chrome plated, satinée/satinée	R7s	TRIAC	max. 120 W	SM3173	294,12 €	350,00 €
	glanzverchromt, satinée/Raster chrome plated, satinée/raster	R7s	TRIAC	max. 120 W	SM3177	294,12 €	350,00 €

SML Wall L

Abbildung figure	Beschreibung description	Fassung socket	Regelung control	Leistung power	Art.-Nr. art.-no.	€ netto DE excl. VAT	€ brutto DE incl. VAT
	silber, satinée/satinée silver, satinée/satinée	R7s	TRIAC	max. 160 W	SM1174	285,71 €	340,00 €
	silber, satinée/Raster silver, satinée/raster	R7s	TRIAC	max. 160 W	SM1175	285,71 €	340,00 €
	glanzverchromt, satinée/satinée chrome plated, satinée/satinée	R7s	TRIAC	max. 160 W	SM3174	323,53 €	385,00 €
	glanzverchromt, satinée/Raster chrome plated, satinée/raster	R7s	TRIAC	max. 160 W	SM3176	323,53 €	385,00 €

SML² Wall

Mit ihrem radikal reduzierten Design und exklusiver Ausstattung hat sich die SML-Familie als ein Markenzeichen des Unternehmens etabliert. Die SML²-Linie eröffnet mit sechs Größenausführungen erweiterte Einsatzmöglichkeiten und Modularität. Auch SML² ist mit nur 25 mm Bauhöhe modular kombinierbar mit allen anderen Versionen.

With its radically reduced design and exclusive features, the SML line has established itself as one of the serien trademark ranges. The SML² line comes in six lengths and offers wide application range and extended modularity. With its height of just 25 mm SML² can be modularly combined with all other versions.



reddot design award
winner 2013

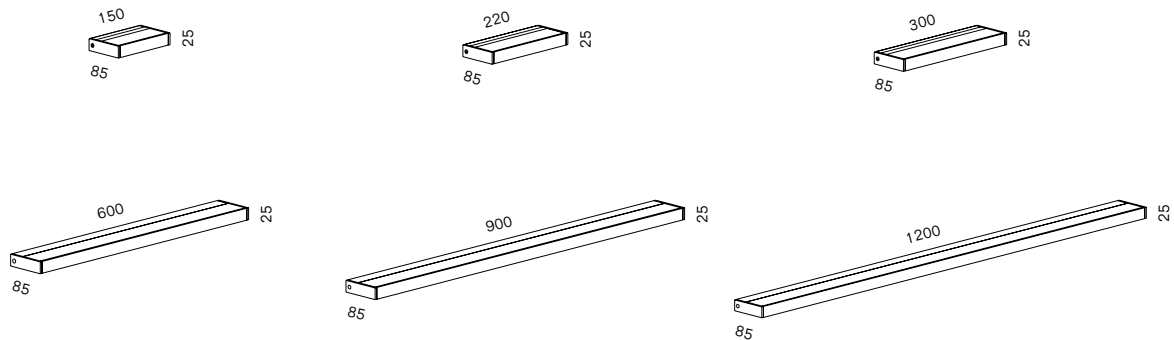

Licht
light

Abhängig von gewählter Leuchtmittelabdeckung symmetrisch nach oben und unten gestreut oder zu einer Seite gestreut, zur anderen abgeblendet
depending on the chosen illuminant covers symmetrical scattering upward and downward or scattered to one side, dimmed to the other

Leuchtmittel
lamp

LED 10–40 W, CRI Ra>90 (R9>50), EEK/EEC F

Material
material

Aluminium poliert oder Aluminium schwarz, silber oder weiß lackiert; Leuchtmittelabdeckungen; Polycarbonat
aluminium polished or aluminium lacquered black, silver or white; Illuminant covers: polycarbonate

Sonstiges
features

LED austauschbar
LED exchangeable

SML² Wall – Zubehör / Accessories









Wandabdeckungen
Wall covers

Zur Abdeckung von z. B. Anschlussdosen finden Sie passende Wandabdeckungen auf Seite 203.
To cover e.g. junction boxes wall matching covers can be found on page 203.









Wandadapter
Wall adapters

Montagehilfe bei nicht mittigem Stromanschluss finden Sie auf Seite 202.
Mounting aid for centered power connection can be found on page 202.









SML² Wall 150

Abbildung figure	Beschreibung description	Leuchtmittel lamp	Regelung control	Leistung power	CCT	Lumen lumen	Art.-Nr. art.-no.	€ netto DE excl. VAT	€ brutto DE incl. VAT
	silber, satinée/satinée silver, satinée/satinée	LED	ON/OFF	10 W	2700 K	1110 lm	SM1325	348,74 €	415,00 €
					3000 K	1130 lm	SM1227	348,74 €	415,00 €
	silber, satinée/Raster silver, satinée/raster	LED	ON/OFF	10 W	2700 K	1110 lm	SM1326	348,74 €	415,00 €
					3000 K	1130 lm	SM1228	348,74 €	415,00 €
	weiß, satinée/satinée white, satinée/satinée	LED	ON/OFF	10 W	2700 K	1110 lm	SM1327	348,74 €	415,00 €
					3000 K	1130 lm	SM1229	348,74 €	415,00 €
	weiß, satinée/Raster white, satinée/raster	LED	ON/OFF	10 W	2700 K	1110 lm	SM1328	348,74 €	415,00 €
					3000 K	1130 lm	SM1230	348,74 €	415,00 €
	schwarz, satinée/satinée black, satinée/satinée	LED	ON/OFF	10 W	2700 K	1110 lm	SM1329	348,74 €	415,00 €
					3000 K	1130 lm	SM1231	348,74 €	415,00 €
	schwarz, satinée/Raster black, satinée/raster	LED	ON/OFF	10 W	2700 K	1110 lm	SM1330	348,74 €	415,00 €
					3000 K	1130 lm	SM1232	348,74 €	415,00 €
	poliert, satinée/satinée polished, satinée/satinée	LED	ON/OFF	10 W	2700 K	1110 lm	SM1331	394,96 €	470,00 €
					3000 K	1130 lm	SM1233	394,96 €	470,00 €
	poliert, satinée/Raster polished, satinée/raster	LED	ON/OFF	10 W	2700 K	1110 lm	SM1332	394,96 €	470,00 €
					3000 K	1130 lm	SM1234	394,96 €	470,00 €









SML² Wall 220

Abbildung figure	Beschreibung description	Leuchtmittel lamp	Regelung control	Leistung power	CCT	Lumen lumen	Art.-Nr. art.-no.	€ netto DE excl. VAT	€ brutto DE incl. VAT
	silber, satinée/satinée silver, satinée/satinée	LED	TRIAC	15 W	2700 K	1540 lm	SM1333	436,97 €	520,00 €
					3000 K	1560 lm	SM1235	436,97 €	520,00 €
	silber, satinée/Raster silver, satinée/raster	LED	TRIAC	15 W	2700 K	1540 lm	SM1334	436,97 €	520,00 €
					3000 K	1560 lm	SM1236	436,97 €	520,00 €
	weiß, satinée/satinée white, satinée/satinée	LED	TRIAC	15 W	2700 K	1540 lm	SM1335	436,97 €	520,00 €
					3000 K	1560 lm	SM1237	436,97 €	520,00 €
	weiß, satinée/Raster white, satinée/raster	LED	TRIAC	15 W	2700 K	1540 lm	SM1336	436,97 €	520,00 €
					3000 K	1560 lm	SM1238	436,97 €	520,00 €
	schwarz, satinée/satinée black, satinée/satinée	LED	TRIAC	15 W	2700 K	1540 lm	SM1337	436,97 €	520,00 €
					3000 K	1560 lm	SM1239	436,97 €	520,00 €
	schwarz, satinée/Raster black, satinée/raster	LED	TRIAC	15 W	2700 K	1540 lm	SM1338	436,97 €	520,00 €
					3000 K	1560 lm	SM1240	436,97 €	520,00 €
	poliert, satinée/satinée polished, satinée/satinée	LED	TRIAC	15 W	2700 K	1540 lm	SM1339	478,99 €	570,00 €
					3000 K	1560 lm	SM1241	478,99 €	570,00 €
	poliert, satinée/Raster polished, satinée/raster	LED	TRIAC	15 W	2700 K	1540 lm	SM1340	478,99 €	570,00 €
					3000 K	1560 lm	SM1242	478,99 €	570,00 €

SML² Wall 300









Abbildung figure	Beschreibung description	Leuchtmittel lamp	Regelung control	Leistung power	CCT	Lumen lumen	Art.-Nr. art.-no.	€ netto DE excl. VAT	€ brutto DE incl. VAT
	silber, satinée/satinée silver, satinée/satinée	LED	TRIAC	20 W	2700 K	2090 lm	SM1341	529,41 €	630,00 €
					3000 K	2130 lm	SM1243	529,41 €	630,00 €
			DALI	20 W	2700 K	2090 lm	SM1601	554,62 €	660,00 €
					3000 K	2130 lm	SM1602	554,62 €	660,00 €
	silber, satinée/Raster silver, satinée/raster	LED	TRIAC	20 W	2700 K	2090 lm	SM1342	529,41 €	630,00 €
					3000 K	2130 lm	SM1244	529,41 €	630,00 €
			DALI	20 W	2700 K	2090 lm	SM1603	554,62 €	660,00 €
					3000 K	2130 lm	SM1604	554,62 €	660,00 €
	weiß, satinée/satinée white, satinée/satinée	LED	TRIAC	20 W	2700 K	2090 lm	SM1343	529,41 €	630,00 €
					3000 K	2130 lm	SM1245	529,41 €	630,00 €
			DALI	20 W	2700 K	2090 lm	SM1605	554,62 €	660,00 €
					3000 K	2130 lm	SM1606	554,62 €	660,00 €
	weiß, satinée/Raster white, satinée/raster	LED	TRIAC	20 W	2700 K	2090 lm	SM1344	529,41 €	630,00 €
					3000 K	2130 lm	SM1246	529,41 €	630,00 €
			DALI	20 W	2700 K	2090 lm	SM1607	554,62 €	660,00 €
					3000 K	2130 lm	SM1608	554,62 €	660,00 €
	schwarz, satinée/satinée black, satinée/satinée	LED	TRIAC	20 W	2700 K	2090 lm	SM1345	529,41 €	630,00 €
					3000 K	2130 lm	SM1247	529,41 €	630,00 €
			DALI	20 W	2700 K	2090 lm	SM1609	554,62 €	660,00 €
					3000 K	2130 lm	SM1610	554,62 €	660,00 €
	schwarz, satinée/Raster black, satinée/raster	LED	TRIAC	20 W	2700 K	2090 lm	SM1346	529,41 €	630,00 €
					3000 K	2130 lm	SM1248	529,41 €	630,00 €
			DALI	20 W	2700 K	2090 lm	SM1611	554,62 €	660,00 €
					3000 K	2130 lm	SM1612	554,62 €	660,00 €
	poliert, satinée/satinée polished, satinée/satinée	LED	TRIAC	20 W	2700 K	2090 lm	SM1347	571,43 €	680,00 €
					3000 K	2130 lm	SM1249	571,43 €	680,00 €
			DALI	20 W	2700 K	2090 lm	SM1613	596,64 €	710,00 €
					3000 K	2130 lm	SM1614	596,64 €	710,00 €
	poliert, satinée/Raster polished, satinée/raster	LED	TRIAC	20 W	2700 K	2090 lm	SM1348	571,43 €	680,00 €
					3000 K	2130 lm	SM1250	571,43 €	680,00 €
			DALI	20 W	2700 K	2090 lm	SM1615	596,64 €	710,00 €
					3000 K	2130 lm	SM1616	596,64 €	710,00 €

SML² Wall 600

Abbildung figure	Beschreibung description	Leuchtmittel lamp	Regelung control	Leistung power	CCT	Lumen lumen	Art.-Nr. art.-no.	€ netto DE excl. VAT	€ brutto DE incl. VAT
	silber, satinée/satinée silver, satinée/satinée	LED	TRIAC	20 W	2700 K	2050 lm	SM1701	529,41 €	630,00 €
					3000 K	2080 lm	SM1801	529,41 €	630,00 €
					2700 K	2050 lm	SM1349	529,41 €	630,00 €
			DALI	20 W	3000 K	2080 lm	SM1251	529,41 €	630,00 €
					2700 K–5000 K TW	2100 lm	SM1501	571,43 €	680,00 €
					<hr/>				
	silber, satinée/Raster silver, satinée/raster	LED	TRIAC	20 W	2700 K	2050 lm	SM1702	529,41 €	630,00 €
					3000 K	2080 lm	SM1802	529,41 €	630,00 €
					2700 K	2050 lm	SM1350	529,41 €	630,00 €
			DALI	20 W	3000 K	2080 lm	SM1252	529,41 €	630,00 €
					2700 K–5000 K TW	2100 lm	SM1502	571,43 €	680,00 €
					<hr/>				
	weiß, satinée/satinée white, satinée/satinée	LED	TRIAC	20 W	2700 K	2050 lm	SM1703	529,41 €	630,00 €
					3000 K	2080 lm	SM1803	529,41 €	630,00 €
					2700 K	2050 lm	SM1351	529,41 €	630,00 €
			DALI	20 W	3000 K	2080 lm	SM1253	529,41 €	630,00 €
					2700 K–5000 K TW	2100 lm	SM1503	571,43 €	680,00 €
					<hr/>				
	weiß, satinée/Raster white, satinée/raster	LED	TRIAC	20 W	2700 K	2050 lm	SM1704	529,41 €	630,00 €
					3000 K	2080 lm	SM1804	529,41 €	630,00 €
					2700 K	2050 lm	SM1352	529,41 €	630,00 €
			DALI	20 W	3000 K	2080 lm	SM1254	529,41 €	630,00 €
					2700 K–5000 K TW	2100 lm	SM1504	571,43 €	680,00 €
					<hr/>				
	schwarz, satinée/satinée black, satinée/satinée	LED	TRIAC	20 W	2700 K	2050 lm	SM1705	529,41 €	630,00 €
					3000 K	2080 lm	SM1805	529,41 €	630,00 €
					2700 K	2050 lm	SM1353	529,41 €	630,00 €
			DALI	20 W	3000 K	2080 lm	SM1255	529,41 €	630,00 €
					2700 K–5000 K TW	2100 lm	SM1505	571,43 €	680,00 €
					<hr/>				
	schwarz, satinée/Raster black, satinée/raster	LED	TRIAC	20 W	2700 K	2050 lm	SM1706	529,41 €	630,00 €
					3000 K	2080 lm	SM1806	529,41 €	630,00 €
					2700 K	2050 lm	SM1354	529,41 €	630,00 €
			DALI	20 W	3000 K	2080 lm	SM1256	529,41 €	630,00 €
					2700 K–5000 K TW	2100 lm	SM1506	571,43 €	680,00 €
					<hr/>				
	poliert, satinée/satinée polished, satinée/satinée	LED	TRIAC	20 W	2700 K	2050 lm	SM1707	571,43 €	680,00 €
					3000 K	2080 lm	SM1807	571,43 €	680,00 €
					2700 K	2050 lm	SM1355	571,43 €	680,00 €
			DALI	20 W	3000 K	2080 lm	SM1257	571,43 €	680,00 €
					2700 K–5000 K TW	2100 lm	SM1507	621,85 €	740,00 €
					<hr/>				
	poliert, satinée/Raster polished, satinée/raster	LED	TRIAC	20 W	2700 K	2050 lm	SM1708	571,43 €	680,00 €
					3000 K	2080 lm	SM1808	571,43 €	680,00 €
					2700 K	2050 lm	SM1356	571,43 €	680,00 €
			DALI	20 W	3000 K	2080 lm	SM1258	571,43 €	680,00 €
					2700 K–5000 K TW	2100 lm	SM1508	621,85 €	740,00 €
					<hr/>				

WALL

SML² Wall 900

Abbildung figure	Beschreibung description	Leuchtmittel lamp	Regelung control	Leistung power	CCT	Lumen lumen	Art.-Nr. art.-no.	€ netto DE excl. VAT	€ brutto DE incl. VAT
	silber, satinée/satinée silver, satinée/satinée	LED	TRIAC	30 W	2700 K	3070 lm	SM1709	579,83 €	690,00 €
					3000 K	3120 lm	SM1809	579,83 €	690,00 €
					2700 K	3070 lm	SM1357	579,83 €	690,00 €
			DALI	30 W	3000 K	3120 lm	SM1259	579,83 €	690,00 €
					2700 K–5000 K TW	3200 lm	SM1511	647,06 €	770,00 €
					2700 K	3070 lm	SM1710	579,83 €	690,00 €
	silber, satinée/Raster silver, satinée/raster	LED	TRIAC	30 W	3000 K	3120 lm	SM1810	579,83 €	690,00 €
					2700 K	3070 lm	SM1358	579,83 €	690,00 €
					2700 K	3070 lm	SM1358	579,83 €	690,00 €
			DALI	30 W	3000 K	3120 lm	SM1260	579,83 €	690,00 €
					2700 K–5000 K TW	3200 lm	SM1512	647,06 €	770,00 €
					2700 K	3070 lm	SM1711	579,83 €	690,00 €
	weiß, satinée/satinée white, satinée/satinée	LED	TRIAC	30 W	3000 K	3120 lm	SM1811	579,83 €	690,00 €
					2700 K	3070 lm	SM1359	579,83 €	690,00 €
					2700 K	3070 lm	SM1359	579,83 €	690,00 €
			DALI	30 W	3000 K	3120 lm	SM1261	579,83 €	690,00 €
					2700 K–5000 K TW	3200 lm	SM1513	647,06 €	770,00 €
					2700 K	3070 lm	SM1712	579,83 €	690,00 €
	weiß, satinée/Raster white, satinée/raster	LED	TRIAC	30 W	3000 K	3120 lm	SM1812	579,83 €	690,00 €
					2700 K	3070 lm	SM1360	579,83 €	690,00 €
					2700 K	3070 lm	SM1360	579,83 €	690,00 €
			DALI	30 W	3000 K	3120 lm	SM1262	579,83 €	690,00 €
					2700 K–5000 K TW	3200 lm	SM1514	647,06 €	770,00 €
					2700 K	3070 lm	SM1713	579,83 €	690,00 €
	schwarz, satinée/satinée black, satinée/satinée	LED	TRIAC	30 W	3000 K	3120 lm	SM1813	579,83 €	690,00 €
					2700 K	3070 lm	SM1361	579,83 €	690,00 €
					2700 K	3070 lm	SM1361	579,83 €	690,00 €
			DALI	30 W	3000 K	3120 lm	SM1263	579,83 €	690,00 €
					2700 K–5000 K TW	3200 lm	SM1515	647,06 €	770,00 €
					2700 K	3070 lm	SM1714	579,83 €	690,00 €
	schwarz, satinée/Raster black, satinée/raster	LED	TRIAC	30 W	3000 K	3120 lm	SM1814	579,83 €	690,00 €
					2700 K	3070 lm	SM1362	579,83 €	690,00 €
					2700 K	3070 lm	SM1362	579,83 €	690,00 €
			DALI	30 W	3000 K	3120 lm	SM1264	579,83 €	690,00 €
					2700 K–5000 K TW	3200 lm	SM1516	647,06 €	770,00 €
					2700 K	3070 lm	SM1715	621,85 €	740,00 €
	poliert, satinée/satinée polished, satinée/satinée	LED	TRIAC	30 W	3000 K	3120 lm	SM1815	621,85 €	740,00 €
					2700 K	3070 lm	SM1363	621,85 €	740,00 €
					2700 K	3070 lm	SM1363	621,85 €	740,00 €
			DALI	30 W	3000 K	3120 lm	SM1265	621,85 €	740,00 €
					2700 K–5000 K TW	3200 lm	SM1517	689,08 €	820,00 €
					2700 K	3070 lm	SM1716	621,85 €	740,00 €
	poliert, satinée/Raster polished, satinée/raster	LED	TRIAC	30 W	3000 K	3120 lm	SM1816	621,85 €	740,00 €
					2700 K	3070 lm	SM1364	621,85 €	740,00 €
					2700 K	3070 lm	SM1364	621,85 €	740,00 €
			DALI	30 W	3000 K	3120 lm	SM1266	621,85 €	740,00 €
					2700 K–5000 K TW	3200 lm	SM1518	689,08 €	820,00 €
					2700 K	3070 lm	SM1716	621,85 €	740,00 €

SML² Wall 1200

Abbildung figure	Beschreibung description	Leuchtmittel lamp	Regelung control	Leistung power	CCT	Lumen lumen	Art.-Nr. art.-no.	€ netto DE excl. VAT	€ brutto DE incl. VAT
● ⊖	silber, satinée/satinée silver, satinée/satinée	LED	TRIAC	40 W	2700 K	4000 lm	SM1717	663,87 €	790,00 €
					3000 K	4180 lm	SM1817	663,87 €	790,00 €
					2700 K	4000 lm	SM1365	663,87 €	790,00 €
			DALI	40 W	3000 K	4180 lm	SM1267	663,87 €	790,00 €
					2700 K–5000 K TW	4350 lm	SM1521	764,71 €	910,00 €
● ⊕	silber, satinée/Raster silver, satinée/raster	LED	TRIAC	40 W	2700 K	4000 lm	SM1718	663,87 €	790,00 €
					3000 K	4180 lm	SM1818	663,87 €	790,00 €
					2700 K	4000 lm	SM1366	663,87 €	790,00 €
			DALI	40 W	3000 K	4180 lm	SM1268	663,87 €	790,00 €
					2700 K–5000 K TW	4350 lm	SM1522	764,71 €	910,00 €
○ ⊖	weiß, satinée/satinée white, satinée/satinée	LED	TRIAC	40 W	2700 K	4000 lm	SM1719	663,87 €	790,00 €
					3000 K	4180 lm	SM1819	663,87 €	790,00 €
					2700 K	4000 lm	SM1367	663,87 €	790,00 €
			DALI	40 W	3000 K	4180 lm	SM1269	663,87 €	790,00 €
					2700 K–5000 K TW	4350 lm	SM1523	764,71 €	910,00 €
○ ⊕	weiß, satinée/Raster white, satinée/raster	LED	TRIAC	40 W	2700 K	4000 lm	SM1720	663,87 €	790,00 €
					3000 K	4180 lm	SM1820	663,87 €	790,00 €
					2700 K	4000 lm	SM1368	663,87 €	790,00 €
			DALI	40 W	3000 K	4180 lm	SM1270	663,87 €	790,00 €
					2700 K–5000 K TW	4350 lm	SM1524	764,71 €	910,00 €
● ⊖	schwarz, satinée/satinée black, satinée/satinée	LED	TRIAC	40 W	2700 K	4000 lm	SM1721	663,87 €	790,00 €
					3000 K	4180 lm	SM1821	663,87 €	790,00 €
					2700 K	4000 lm	SM1369	663,87 €	790,00 €
			DALI	40 W	3000 K	4180 lm	SM1271	663,87 €	790,00 €
					2700 K–5000 K TW	4350 lm	SM1525	764,71 €	910,00 €
● ⊕	schwarz, satinée/Raster black, satinée/raster	LED	TRIAC	40 W	2700 K	4000 lm	SM1722	663,87 €	790,00 €
					3000 K	4180 lm	SM1822	663,87 €	790,00 €
					2700 K	4000 lm	SM1370	663,87 €	790,00 €
			DALI	40 W	3000 K	4180 lm	SM1272	663,87 €	790,00 €
					2700 K–5000 K TW	4350 lm	SM1526	764,71 €	910,00 €
● ⊖	poliert, satinée/satinée polished, satinée/satinée	LED	TRIAC	40 W	2700 K	4000 lm	SM1723	705,88 €	840,00 €
					3000 K	4180 lm	SM1823	705,88 €	840,00 €
					2700 K	4000 lm	SM1371	705,88 €	840,00 €
			DALI	40 W	3000 K	4180 lm	SM1273	705,88 €	840,00 €
					2700 K–5000 K TW	4350 lm	SM1527	806,72 €	960,00 €
● ⊕	poliert, satinée/Raster polished, satinée/raster	LED	TRIAC	40 W	2700 K	4000 lm	SM1724	705,88 €	840,00 €
					3000 K	4180 lm	SM1824	705,88 €	840,00 €
					2700 K	4000 lm	SM1372	705,88 €	840,00 €
			DALI	40 W	3000 K	4180 lm	SM1274	705,88 €	840,00 €
					2700 K–5000 K TW	4350 lm	SM1528	806,72 €	960,00 €

WALL



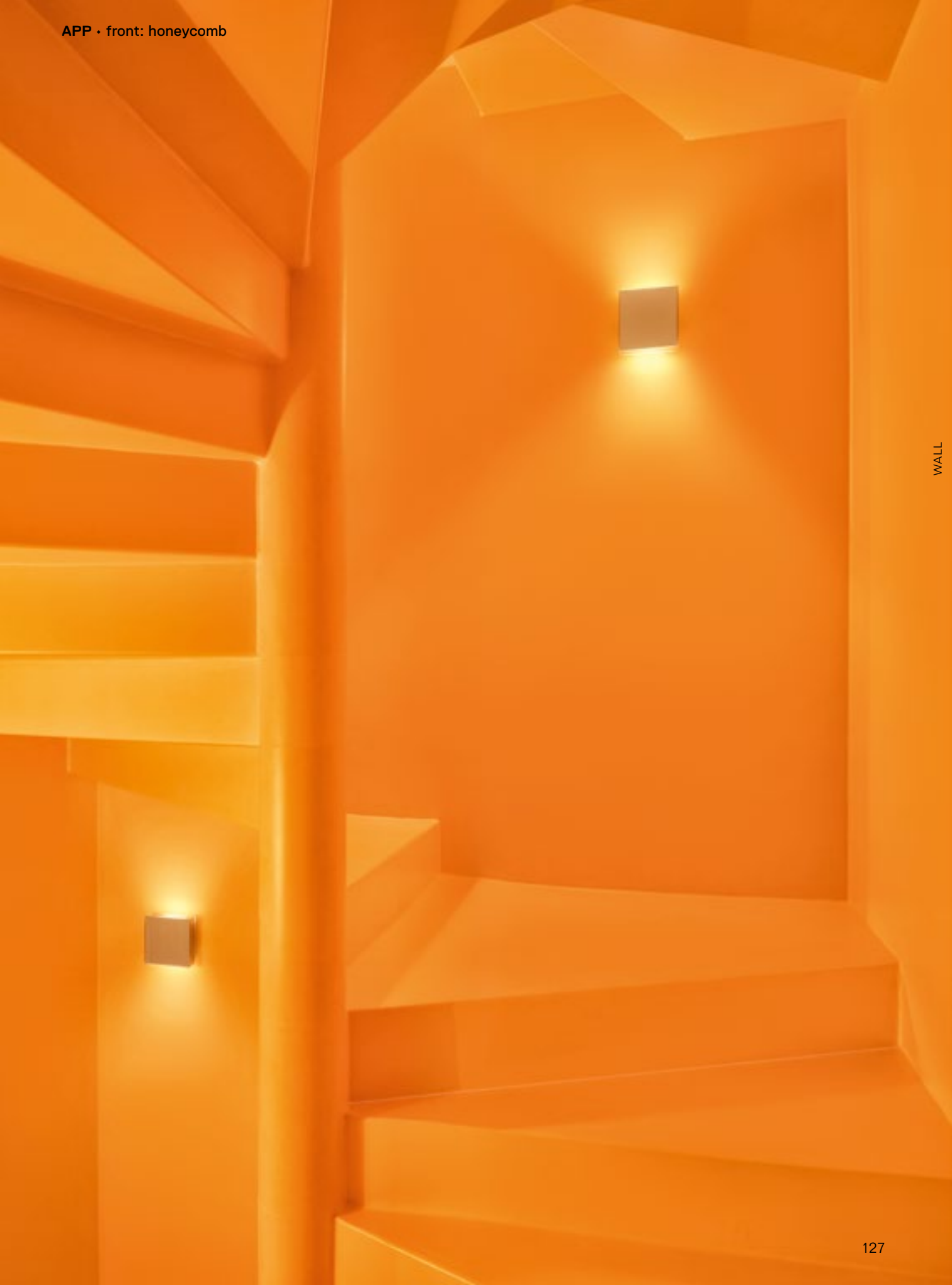

WALL



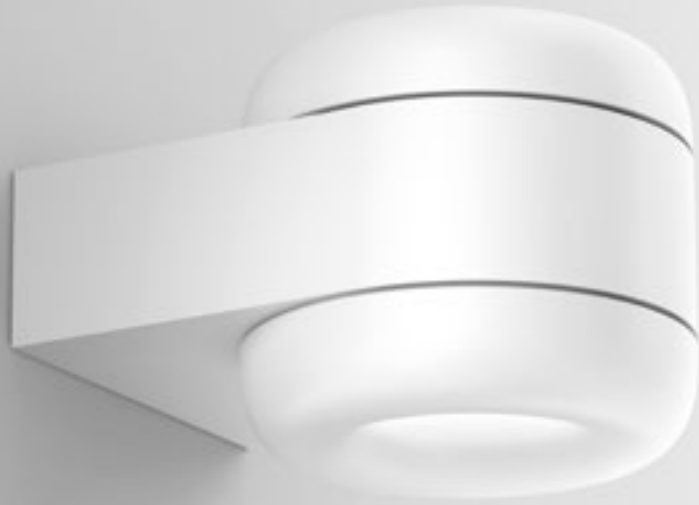





glass clear



glass new silver



acrylic glass clear











WALL







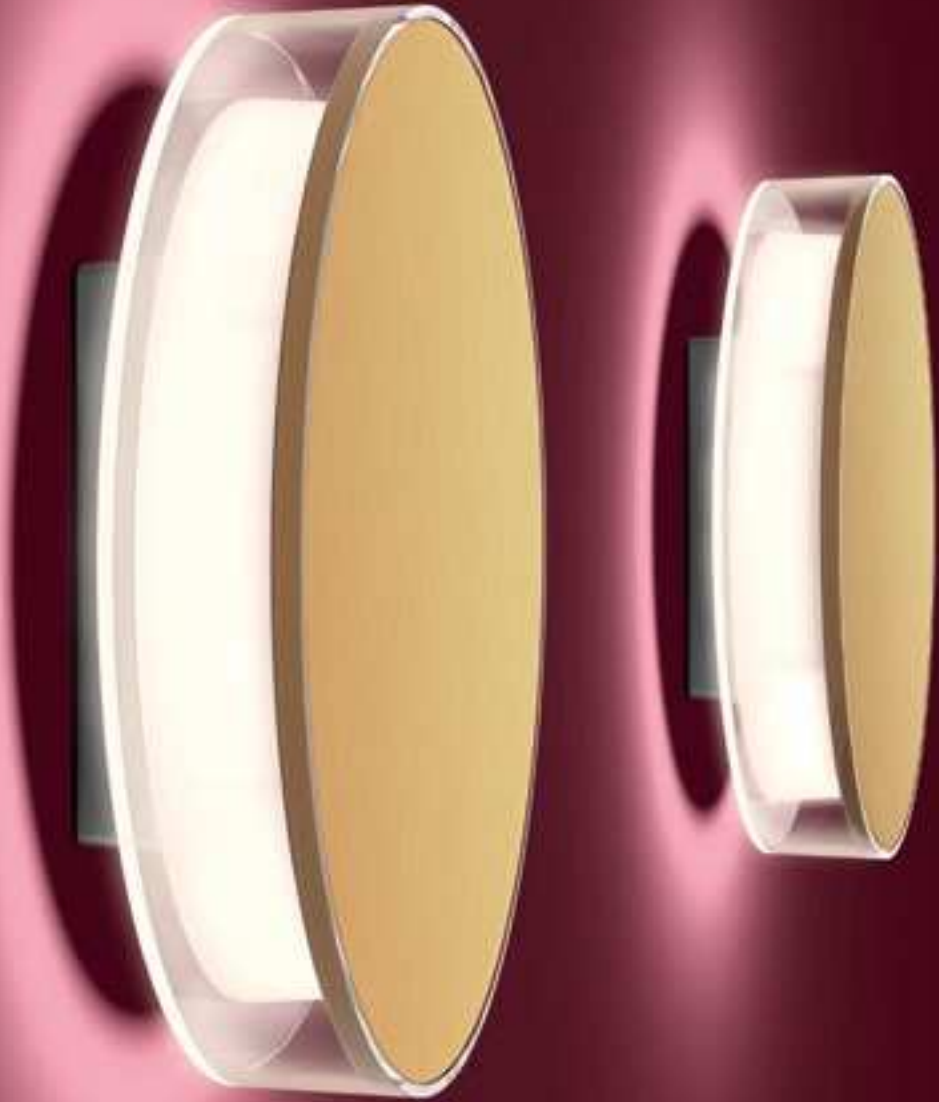

POPPY Wall • 2 arms: beige • shades: violet



3 arms: beige • shade: ceramic



3 arms: black • shade: ruby red



3 arms: black • shade: violet







REFLEX² Wall M · black



WALL

REFLEX² Wall M · white







WALL





WALL

5	...
4	...
3	...
2	...
1	...
0	...
-1	...







polished

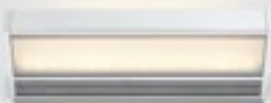

silver

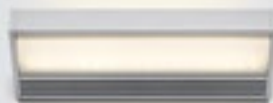

black





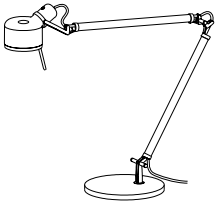

JOB
S. 155



POPPY
S. 156

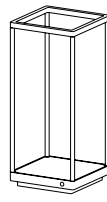

REFLEX²
S. 157
new

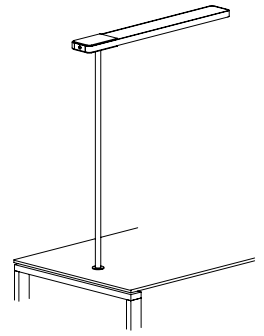

SLICE²
S. 158

JOB Table

An dieser exklusiven Variante der klassischen Schreibtischleuchte kann sich auch ein scharfes Auge lange erfreuen: alle Metallteile aus massivem, poliertem Edelstahl, Arme aus Echtglas, sorgfältigste Details (die Unterseite des Sockels ist mit Leder bezogen). JOB überzeugt auch funktional: auch bei Höchstleistung bleibt der Leuchtenkopf kühl. Dort– Wo man ihn braucht–ist auch der Schalter/Dimmer. Und Sie haben vier Befestigungen zur Wahl: Tisch-Sockel oder Tisch-Klemme, Möbeladapter für direktes Einstecken in Tischplatten oder Adapter für USM Haller-Tischsysteme.



Even a keen eye will enjoy a good long look at this exclusive version of the classic writing desk lamp: desk lamp: solid, polished stainless steel parts, genuine glass arms and great attention to details (the bottom of the base is covered with leather) JOB also stands out with regard to function: even when fully operational the head of the lamp remains cool. The switch/dimmer is also just where it is needed. And there is a choice of four mounts: Table-base or table-clamp, furniture adapter for direct fitting onto table tops or adapter for USM Haller table systems.

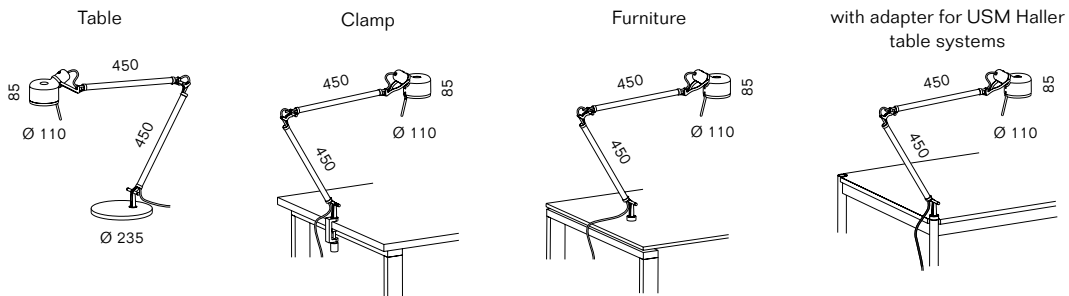

Licht light	direkt, seitlich abgeschirmt directly, laterally shielded
Leuchtmittel lamp	LED 13 W E27, CRI Ra>90 (R9>50), EEK/EEC D
Material material	Tisch-Sockel: Edelstahl poliert, unterseitig Echtleder; Tisch-Klemme und -Adapter: Edelstahl poliert Rohre: Borosilikatglas und Edelstahl poliert; Schirm: Edelstahl poliert und Borosilikatglas table base: stainless steel polished, bottom side real leather; table clamp and furniture adapter: stainless steel polished, tubes: borosilicate glass and stainless steel polished; shade: stainless steel polished and borosilicate glass
Sonstiges features	LED-Retrofit in Lieferung enthalten; An/Aus Dimmung über Taster am Leuchtenkopf LED-Retrofit included in delivery; on/off dimming via button on the head

JOB Table

Abbildung figure	Beschreibung description	Leuchtmittel lamp	Regelung control	Leistung power	CCT	Lumen lumen	Art.-Nr. art.-no.	€ netto DE excl. VAT	€ brutto DE incl. VAT
	Table	LED E27	integr.	13 W	2200–2700 K D2W	1521 lm	JB1013	1.218,49 €	1.450,00 €
	Clamp	LED E27	integr.	13 W	2200–2700 K D2W	1521 lm	JB1014	1.025,21 €	1.220,00 €
	Furniture	LED E27	integr.	13 W	2200–2700 K D2W	1521 lm	JB1015	941,18 €	1.120,00 €
	mit Adapter für USM Haller Tischsysteme with adapter for USM Haller table systems	LED E27	integr.	13 W	2200–2700 K D2W	1521 lm	JB1016	941,18 €	1.120,00 €

POPPY Table

Werden die „Mohnblüten“ dieser Familie durch Einschalten geweckt, öffnen sich ihre Schirme ganz allmählich: die feinen Blätter sind aus Bimetall und dehnen sich durch Erwärmung aus. Alle Varianten können nach Belieben umgestaltet werden. Der flexible, textilmantelte Schlauch lässt sich immer neu biegen – zur Änderung der Lichtrichtung, oder einfach weil Ihnen danach ist. Die mundgeblasenen Glaskapseln sind erhältlich in den Farben keramik, rubinrot oder violett.

When the “poppy flowers” in this family are woken by the lamp being switched on, their shades open very gradually: the delicate leaves are bi-metallic and expand when heated. All the versions can be reshaped as desired. The flexible, textile-coated stem can be bent at will, to change the direction of the light, or because you just feel like it. The hand-blown glass capsules are available in the colours ceramic, ruby red or violet.

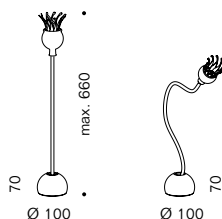

Licht light	nach vorne gerichtet, seitlich abgeschirmt directed forward, shielded to the sides
Leuchtmittel lamp	G4 35 W, 12 V, EEK/EEC G
Material material	Arme, flexibel: Aluminium, textilmantelt beige oder schwarz; Glasschirme: mundgeblasenes Glas in keramik, rubinrot oder violett; Lamellen: Bimetall; Sockel: Edelstahl, poliert arms, flexible: textile coated aluminium tube in beige or black; glass shade: hand-blown glass in ceramic, ruby red or violet; lamellae: bimetal; base: stainless steel, polished
Sonstiges features	Leuchtmittel in Lieferung enthalten; Reflektor-Lamellen öffnen sich nach ca. 2 Minuten Betriebszeit; Leuchte kann auch als Wandleuchte montiert werden lamps included in delivery; lamellae open within approx. 2 minutes after switching on luminaire; luminaire can also be mounted as wall luminaire

POPPY Table

Abbildung figure	Beschreibung description	Fassung socket	Regelung control	Leistung power	Art.-Nr. art.-no.	€ netto DE excl. VAT	€ brutto DE incl. VAT
	Arme schwarz, Schirm keramik arms black, shade ceramic	G4	ON/OFF	max. 35 W	PO1001	352,94 €	420,00 €
	Arme schwarz, Schirm rubinrot arms black, shade ruby red	G4	ON/OFF	max. 35 W	PO1002	352,94 €	420,00 €
	Arme schwarz, Schirm violett arms black, shade violet	G4	ON/OFF	max. 35 W	PO1003	352,94 €	420,00 €
	Arme beige, Schirm keramik arms beige shade ceramic	G4	ON/OFF	max. 35 W	PO1022	352,94 €	420,00 €
	Arme beige, Schirm rubinrot arms beige shade ruby red	G4	ON/OFF	max. 35 W	PO1023	352,94 €	420,00 €
	Arme beige, Schirm violett arms beige shade violet	G4	ON/OFF	max. 35 W	PO1024	352,94 €	420,00 €

REFLEX² Table new available Q1 2023

REFLEX² Table erweitert die Produktfamilie um eine feine, filigrane Tischleuchte. Mit ihrer offenen, graphischen Anmutung sorgt REFLEX² Table auf Tisch, Sideboard oder Boden für intensives, nach unten gerichtetes Licht. Aus einer geometrischen Rahmenstruktur entsteht so eine angenehme und atmosphärische Lichtstimmung im Raum.



REFLEX² Table extends the product family with a fine, filigree table luminaire. With its open, graphic appearance, REFLEX² Table provides intense downward light on a table, sideboard or floor, creating a pleasant and atmospheric lighting mood from a geometric frame structure.

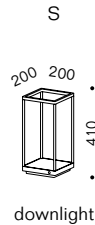

Licht light	nach unten gestreut scattered downwards
Leuchtmittel lamp	LED 33 W, CRI Ra>90 (R9>50) Dim2Warm
Material material	Leuchtmittelabdeckungen: Flachglas satinée lamp cover: glass semigloss
Gehäuse housing	Aluminium schwarz oder weiß beschichtet aluminium black or white coated
Sonstiges features	LED austauschbar; Kabelaufwicklung unter dem Sockel; Taster für on/off/dimming im Sockel LED exchangeable; cable wrap below the base; push button for on/off/dimming in the base

REFLEX² Table S

Abbildung figure	Beschreibung description	Leuchtmittel lamp	Regelung control	Leistung power	CCT	Lumen lumen	Art.-Nr. art.-no.	€ netto DE excl. VAT	€ brutto DE incl. VAT
●	schwarz black	LED	integr.	33 W	2200–3000 K D2W	3910 lm	RE3801	487,39 €	580,00 €
○	weiß white	LED	integr.	33 W	2200–3000 K D2W	3910 lm	RE3802	487,39 €	580,00 €

SLICE² Furniture

Der komplett geschlossene Leuchtenkopf von SLICE² sorgt mit einer besonders innovativen Anordnung der Leuchtmittel auf zwei Ebenen für eine optimale Lichtwirkung: Breit nach oben abstrahlende LED-Streifen bieten indirektes, auch bei voller Leistung absolut blendfreies Licht. Nach unten sorgen LED-Leuchtmittel, deren Licht über die Glaskanten eingespeist und von einer prismatischen Scheibe verteilt wird, für ideales, direktes Licht auf der Arbeitsfläche.

The completely closed luminaire head of SLICE² with its particularly innovative arrangement of illuminants on two levels creates an optimum light effect: Wide-angled upwards-facing LED strips provide indirect light that is entirely glare-free even at full power. Downwards, LEDs whose light is supplied via the glass edges and distributed by a prismatic disk generate ideal direct lighting for work surfaces.

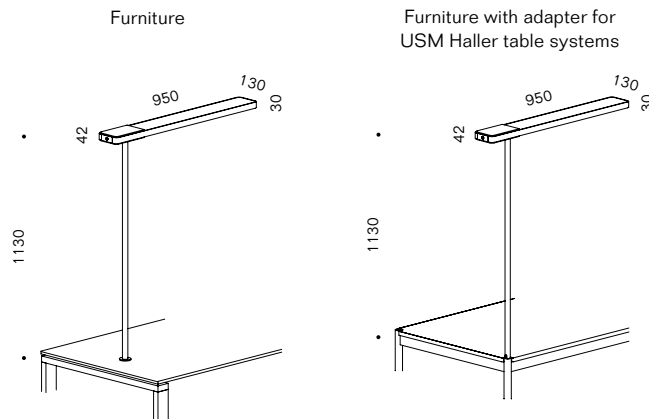

Licht light	direkt nach oben abstrahlend durch Diffusorplatte, nach unten abgeblendet durch Prismenstrukturglas; vereinheitlichte Blendungsbewertung UGR<15, Lichtverteilung: indirekt 85%, direkt 15% beaming upwards through diffuser plate, downwards directed through prism pattern glass; unified glare rating UGR<15, light distribution LED: indirect 85%, direct 15%
Leuchtmittel lamp	LED 2 × 41 W, CRI Ra>80, EEK/EEC C
Material material	Leuchtenkopf und Leuchtenrohr: glanzverchromt, schwarz, weiß oder silber beschichtet; Leuchtmittelabdeckung: unten Prismenstruktur-Acrylglas, oben Acrylglas Diffusor lamp head and tube: chrome-plated, black, white or silver coated; lamp cover: bottom prism pattern acrylic glass, top diffuser acrylic glass
Sonstiges features	LED austauschbar; vereinheitlichte Blendungsbewertung UGR<15; weitere Ausführungen (CCT/CRI/Leistung) möglich LED exchangeable; unified glare rating UGR<15; other technical versions (CCT/CRI/power) on request

SLICE² Furniture

Abbildung figure	Beschreibung description	Leuchtmittel lamp	Regelung control	Leistung power	CCT	Lumen lumen	Art.-Nr. art.-no.	€ netto DE excl. VAT	€ brutto DE incl. VAT
●	glanzverchromt chrome plated	LED	integr.	82 W	3000 K	12710 lm	SL4001	1.336,13 €	1.590,00 €
					4000 K	13345 lm	SL4002	1.336,13 €	1.590,00 €
			Sensorik	82 W	3000 K	12710 lm	SL5001	1.504,20 €	1.790,00 €
					4000 K	13345 lm	SL5002	1.504,20 €	1.790,00 €
●	schwarz black	LED	integr.	82 W	3000 K	12710 lm	SL4101	1.252,10 €	1.490,00 €
					4000 K	13345 lm	SL4102	1.252,10 €	1.490,00 €
			Sensorik	82 W	3000 K	12710 lm	SL5101	1.420,17 €	1.690,00 €
					4000 K	13345 lm	SL5102	1.420,17 €	1.690,00 €
○	weiß white	LED	integr.	82 W	3000 K	12710 lm	SL4201	1.252,10 €	1.490,00 €
					4000 K	13345 lm	SL4202	1.252,10 €	1.490,00 €
			Sensorik	82 W	3000 K	12710 lm	SL5201	1.420,17 €	1.690,00 €
					4000 K	13345 lm	SL5202	1.420,17 €	1.690,00 €
●	silber silver	LED	integr.	82 W	3000 K	12710 lm	SL4301	1.252,10 €	1.490,00 €
					4000 K	13345 lm	SL4302	1.252,10 €	1.490,00 €
			Sensorik	82 W	3000 K	12710 lm	SL5301	1.420,17 €	1.690,00 €
					4000 K	13345 lm	SL5302	1.420,17 €	1.690,00 €

SLICE² Furniture with adapter for USM Haller table systems

Abbildung figure	Beschreibung description	Leuchtmittel lamp	Regelung control	Leistung power	CCT	Lumen lumen	Art.-Nr. art.-no.	€ netto DE excl. VAT	€ brutto DE incl. VAT
●	glanzverchromt chrome plated	LED	integr.	82 W	3000 K	12710 lm	SL4011	1.336,13 €	1.590,00 €
					4000 K	13345 lm	SL4012	1.336,13 €	1.590,00 €
			Sensorik	82 W	3000 K	12710 lm	SL5011	1.504,20 €	1.790,00 €
					4000 K	13345 lm	SL5012	1.504,20 €	1.790,00 €
●	schwarz black	LED	integr.	82 W	3000 K	12710 lm	SL4111	1.252,10 €	1.490,00 €
					4000 K	13345 lm	SL4112	1.252,10 €	1.490,00 €
			Sensorik	82 W	3000 K	12710 lm	SL5111	1.420,17 €	1.690,00 €
					4000 K	13345 lm	SL5112	1.420,17 €	1.690,00 €
○	weiß white	LED	integr.	82 W	3000 K	12710 lm	SL4211	1.252,10 €	1.490,00 €
					4000 K	13345 lm	SL4212	1.252,10 €	1.490,00 €
			Sensorik	82 W	3000 K	12710 lm	SL5211	1.420,17 €	1.690,00 €
					4000 K	13345 lm	SL5212	1.420,17 €	1.690,00 €
●	silber silver	LED	integr.	82 W	3000 K	12710 lm	SL4311	1.252,10 €	1.490,00 €
					4000 K	13345 lm	SL4312	1.252,10 €	1.490,00 €
			Sensorik	82 W	3000 K	12710 lm	SL5311	1.420,17 €	1.690,00 €
					4000 K	13345 lm	SL5312	1.420,17 €	1.690,00 €





TABLE











TABLE



CENTRAL
S. 168



CLUB
S. 169

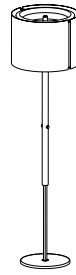

JONES
S. 171

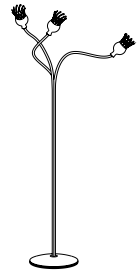

POPPY
S. 172

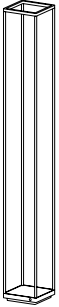

REFLEX²
S. 174
new

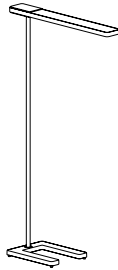

SLICE²
S. 176

CENTRAL Floor

CENTRAL verbindet anmutiges Design mit einem Höchstmaß an Funktionalität und Flexibilität. Mit einer Größe von über zwei Metern in Maximalposition ist CENTRAL Floor ein Blickfang, bleibt dabei jedoch leicht in ihrer Form. Der Clou liegt in den beiden Teleskoparmen aus gebürstetem Edelstahl. Über das vertikale Teleskoprohr lässt sich die Höhe verstellen, mit dem feineren horizontalen Teleskoparm wird die Ausladung angepasst—ob für den Einsatz über dem Couchtisch oder als prägnante Esstischleuchte. Durch die umlaufende Lichtfuge im Schirm fällt ein sanft illuminierendes Licht, das dadurch selbst zum Gestaltungselement wird.

CENTRAL combines graceful design with extreme functionality and flexibility. Measuring over two meters at its maximum height, CENTRAL Floor is a real eye-catcher, yet remains light in terms of form. This is thanks to its two brushed stainless steel telescopic arms. The height can be adjusted via the vertical telescopic tube, and the out-reach via the more delicate horizontal telescopic arm—for use above the coffee table or as a striking outreach luminaire for the dining table. The groove in the shade gives rise to a soft light and in so doing itself becomes a design element.

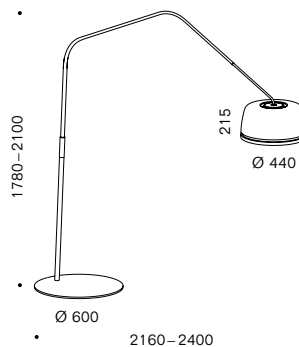

Licht
light **direkt nach unten abstrahlend, durch Lichtfuge sanft illuminierend**
directed downwards, via groove in the shade softly illuminating

Leuchtmittel
lamp LED 27 W CoB, CRI >90, EEK/EEC F

Material
material **Leuchtenarm: Edelstahl gebürstet, Sockel: Stahl schwarz matt oder perlgrau matt beschichtet**
Schirm: Aluminium schwarz matt oder perlgrau matt beschichtet
luminaire arm: brushed stainless steel; light unit: steel coated in matt black or matt pearl gray
shade: coated aluminum in matt black or matt pearl gray



Sonstiges
features **LED austauschbar; dimmbar über Taster im Leuchtschirm**
LED exchangeable; dimmable via switch in the lampshade

CENTRAL Floor

Abbildung figure	Beschreibung description	Leuchtmittel lamp	Regelung control	Leistung power	CCT	Lumen lumen	Art.-Nr. art.-no.	€ netto DE excl. VAT	€ brutto DE incl. VAT
●	perlgrau pearl grey	LED	integr.	27 W	2700 K	2610 lm	CE1019	2.092,44 €	2.490,00 €
●	schwarz black	LED	integr.	27 W	2700 K	2610 lm	CE1017	2.092,44 €	2.490,00 €

CLUB Floor

Diese Familie zeitlos klassischer Schirmleuchten ist für den anspruchsvollen Bedarf optimiert. Statt eines Drahtgestells halten schlanke Aluminiumprofile die nahtlosen Schirmhälften – und vermeiden unschöne Schattenkanten. An den seitlichen Knöpfen ist ihr freundlich-atmosphärisches Licht im oberen und unteren Bereich getrennt zu regeln. Und überflüssiges Kabel wird im Fuß aufgewickelt.

This family of timelessly classical lamps with shades has been improved to satisfy sophisticated demands. Instead of a wire frame, slender aluminum profiles hold the seamless halves of the shade, avoiding unsightly shadow lines. Its friendly, atmospheric light can be regulated separately on the upper and lower section by means of the control knobs on the side. And any superfluous cable is wound up in the light unit.

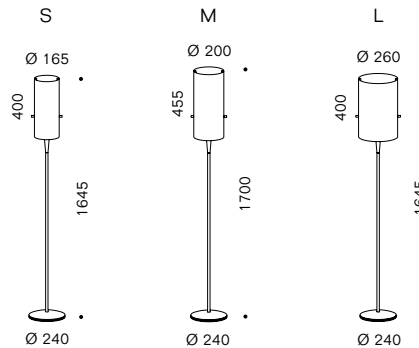





Licht light	nach oben und unten direkt, gerichtet, diffus durch Schirm directly up- and downwards, directional, diffuse through shade
Leuchtmittel lamp	LED up 1 x 10 W CoB, down 2 x 5 W CoB, CRI Ra>97 (R9>93) EEK/EEC F
Material material	Aluminium gebürstet oder schwarz lackiert; Schirm: Chintz weiß oder Melange grau aluminium brushed or black laquered; shade: chintz white or melange grey
Sonstiges features	LED austauschbar; über Tastknöpfe am Schirm getrennt regelbar (on/off/dimmen) LED exchangeable; controlled separately (on/off/dimming) via push buttons on the shade





CLUB Floor S

Abbildung figure	Beschreibung description	Leuchtmittel lamp	Regelung control	Leistung power	CCT	Lumen lumen	Art.-Nr. art.-no.	€ netto DE excl. VAT	€ brutto DE incl. VAT
	gebürstet, Chintz weiß brushed, Chintz white	LED	integr.	20 W	2700 K	1930 lm	CL2101	806,72 €	960,00 €
	schwarz, Chintz weiß black, Chintz white	LED	integr.	20 W	2700 K	1930 lm	CL2102	806,72 €	960,00 €
	gebürstet, Melange grau brushed, Melange grey	LED	integr.	20 W	2700 K	1930 lm	CL2103	806,72 €	960,00 €
	schwarz, Melange grau black, Melange grey	LED	integr.	20 W	2700 K	1930 lm	CL2104	806,72 €	960,00 €

CLUB Floor M

Abbildung figure	Beschreibung description	Leuchtmittel lamp	Regelung control	Leistung power	CCT	Lumen lumen	Art.-Nr. art.-no.	€ netto DE excl. VAT	€ brutto DE incl. VAT
	gebürstet, Chintz weiß brushed, Chintz white	LED	integr.	20 W	2700 K	1930 lm	CL2111	806,72 €	960,00 €
	schwarz, Chintz weiß black, Chintz white	LED	integr.	20 W	2700 K	1930 lm	CL2112	806,72 €	960,00 €
	gebürstet, Melange grau brushed, Melange grey	LED	integr.	20 W	2700 K	1930 lm	CL2113	806,72 €	960,00 €
	schwarz, Melange grau black, Melange grey	LED	integr.	20 W	2700 K	1930 lm	CL2114	806,72 €	960,00 €

CLUB Floor L

Abbildung figure	Beschreibung description	Leuchtmittel lamp	Regelung control	Leistung power	CCT	Lumen lumen	Art.-Nr. art.-no.	€ netto DE excl. VAT	€ brutto DE incl. VAT
	gebürstet, Chintz weiß brushed, Chintz white	LED	integr.	20 W	2700 K	1930 lm	CL2121	806,72 €	960,00 €
	schwarz, Chintz weiß black, Chintz white	LED	integr.	20 W	2700 K	1930 lm	CL2122	806,72 €	960,00 €
	gebürstet, Melange grau brushed, Melange grey	LED	integr.	20 W	2700 K	1930 lm	CL2123	806,72 €	960,00 €
	schwarz, Melange grau black, Melange grey	LED	integr.	20 W	2700 K	1930 lm	CL2124	806,72 €	960,00 €

JONES Floor

Diese diskrete Dame wird auf den ersten Blick gern unterschätzt. JONES ist kräftiger Deckenfluter, intime Leseleuchte und atmosphärische Schirmleuchte in einer Gestalt. Ihre Verwandlung funktioniert ganz einfach über zwei Knöpfe am Standrohr der Leuchte, ein dritter regelt die Helligkeit. Und mit dem farbigen Glaseinsatz leuchtet der weiße Schirm –erhältlich in zwei Größen–auf Wunsch farbig.



At first sight this discreet lady is often underestimated. JONES is a powerful uplight, intimate reading light and atmospheric shade lamp in one. It is transformed extremely easily by means of two buttons on the lamp' upright tube, while a third regulates the brightness. And if desired, a coloured glass insert causes the white shade, which is available in two sizes, to shine in colour.

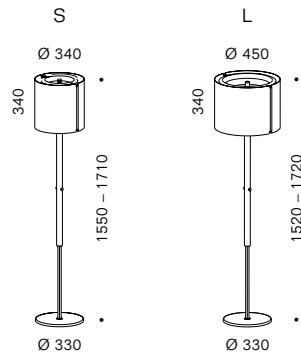

Licht light	stufenlos einstellbar: Leselicht, gerichtet nach unten. Dekoratives Licht, gerichtet nach unten und oben, rundum diffus durch Schirm (farbig durch Glaseinsatz) Indirektes Licht, gerichtet nach oben Infinitely adjustable: reading light, directed downwards. Decorative light, directed downwards and upwards, diffused all around by shade (coloured by glass insert). Indirect light, directed upwards.
Leuchtmittel lamp	LED 38 W CoB, CRI Ra>97 (R9>90), EEK/EEC F E27 max. 205 W, EEK/EEC G (Lieferung ohne Leuchtmittel/delivery without bulb)
Material material	Schirm: Glashartgewebe textilkaschiert weiß. Rundrohr und Sockel: Aluminium gebürstet und schutzlackiert oder schwarz lackiert Vierkantrrohr: Aluminium verchromt. Glaseinsatz: Borosilikatglas orange shade: glass fabric laminated, white; round rod and base: aluminum brushed with protective coating or laquered black square rod: aluminum chrome-plated; colored glass insert: borosilicate glass orange
Sonstiges features	LED austauschbar; farbiger Glaseinsatz leicht und schnell einsetzbar; Taster für on/off/dimming im Standrohr LED exchangeable; colored glass insert easily replaceable; push buttons für on/off/dimming in the standpipe

JONES Floor S

Abbildung figure	Beschreibung description	Leuchtmittel lamp	Regelung control	Leistung power	CCT	Lumen lumen	Art.-Nr. art.-no.	€ netto DE excl. VAT	€ brutto DE incl. VAT
●	gebürstet brushed	LED	integr.	38 W	2700 K	3500 lm	JO3006	1.672,27 €	1.990,00 €
		E27	integr.	max. 205 W	3000 K	4200 lm	JO1010	1.252,10 €	1.490,00 €
●	schwarz black	LED	integr.	38 W	2700 K	3500 lm	JO3106	1.672,27 €	1.990,00 €

JONES Floor L

Abbildung figure	Beschreibung description	Leuchtmittel lamp	Regelung control	Leistung power	CCT	Lumen lumen	Art.-Nr. art.-no.	€ netto DE excl. VAT	€ brutto DE incl. VAT
●	gebürstet brushed	LED	integr.	38 W	2700 K	3500 lm	JO3003	1.672,27 €	1.990,00 €
		E27	integr.	max. 205 W	3000 K	4200 lm	JO1007	1.252,10 €	1.490,00 €
●	schwarz black	LED	integr.	38 W	2700 K	3500 lm	JO3103	1.672,27 €	1.990,00 €

POPPY Floor

Werden die „Mohnblüten“ dieser Familie durch Einschalten geweckt, öffnen sich ihre Schirme ganz allmählich: die feinen Blätter sind aus Bimetall und dehnen sich durch Erwärmung aus. Alle Varianten können nach Belieben umgestaltet werden. Der flexible, textilmantelte Schlauch lässt sich immer neu biegen – zur Änderung der Lichtrichtung, oder einfach weil Ihnen danach ist. Die mundgeblasenen Glaskapseln sind erhältlich in den Farben keramik, rubinrot oder violett.

When the “poppy flowers” in this family are woken by the lamp being switched on, their shades open very gradually: the delicate leaves are bi-metallic and expand when heated. All the versions can be reshaped as desired. The flexible, textile-coated stem can be bent at will, to change the direction of the light, or because you just feel like it. The hand-blown glass capsules are available in the colours ceramic, ruby red or violet.

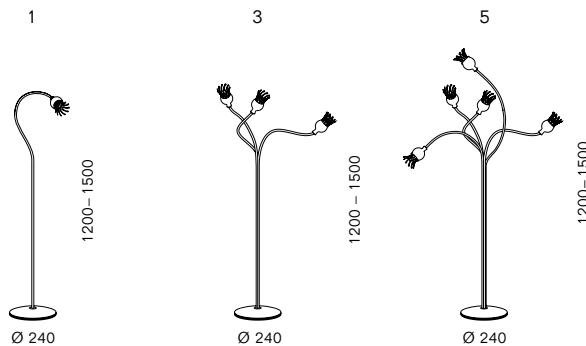







Licht light	nach vorne gerichtet, seitlich abgeschirmt directed forward, shielded to the sides
Leuchtmittel lamp	POPPY Floor 1/3: 1 x/3 x G4 35 W, 12 V, EEK/EEC G POPPY Floor 5: 5 x G4 20 W, 12 V, EEK/EEC G
Material material	Arme, flexibel: Aluminium, textilmantelt beige oder schwarz; Glasschirme: mundgeblasenes Glas keramik, rubinrot oder violett; Lamellen: Bimetall; Sockel: Stahl arms: flexible, textile coated aluminium tube in beige or black; glass shade: hand-blown glass in ceramic, ruby red or violet; lamellae: bimetal; base: steel
Sonstiges features	Leuchtmittel in Lieferung enthalten; Reflektor-Lamellen öffnen sich nach ca. 2 Minuten Betriebszeit lamps included in delivery; lamellae open within approx. 2 minutes after switching on luminaire







POPPY Floor 1

Abbildung figure	Beschreibung description	Fassung lamp	Regelung control	Leistung power	Art.-Nr. art.-no.	€ netto DE excl. VAT	€ brutto DE incl. VAT
	1 Arm schwarz, Schirm keramik 1 arm black, shade ceramic	G4	ON/OFF	35 W	PO1052	495,80 €	590,00 €
	1 Arm schwarz, Schirm rubinrot 1 arm black, shade red	G4	ON/OFF	35 W	PO1051	495,80 €	590,00 €
	1 Arm schwarz, Schirm violett 1 arm black, shade violet	G4	ON/OFF	35 W	PO1050	495,80 €	590,00 €
	1 Arm beige, Schirm keramik 1 arm beige shade ceramic	G4	ON/OFF	35 W	PO1055	495,80 €	590,00 €
	1 Arm beige, Schirm rubinrot 1 arm beige shade red	G4	ON/OFF	35 W	PO1054	495,80 €	590,00 €
	1 Arm beige, Schirm violett 1 arm beige shade violet	G4	ON/OFF	35 W	PO1053	495,80 €	590,00 €

POPPY Floor 3

Abbildung figure	Beschreibung description	Fassung lamp	Regelung control	Leistung power	Art.-Nr. art.-no.	€ netto DE excl. VAT	€ brutto DE incl. VAT
	3 Arme schwarz, Schirme keramik 3 arms black, shades ceramic	3 × G4	ON/OFF	105 W	PO1058	689,08 €	820,00 €
	3 Arme schwarz, Schirme rubinrot 3 arms black, shades red	3 × G4	ON/OFF	105 W	PO1057	689,08 €	820,00 €
	3 Arme schwarz, Schirme violett 3 arms black, shades violet	3 × G4	ON/OFF	105 W	PO1056	689,08 €	820,00 €
	3 Arme beige, Schirme keramik 3 arms beige shades ceramic	3 × G4	ON/OFF	105 W	PO1061	689,08 €	820,00 €
	3 Arme beige, Schirme rubinrot 3 arms beige shades red	3 × G4	ON/OFF	105 W	PO1060	689,08 €	820,00 €
	3 Arme beige, Schirme violett 3 arms beige shades violet	3 × G4	ON/OFF	105 W	PO1059	689,08 €	820,00 €

POPPY Floor 5

Abbildung figure	Beschreibung description	Fassung lamp	Regelung control	Leistung power	Art.-Nr. art.-no.	€ netto DE excl. VAT	€ brutto DE incl. VAT
	5 Arme schwarz, Schirme keramik 5 arms black, shades ceramic	5 × G4	ON/OFF	100 W	PO1064	873,95 €	1.040,00 €
	5 Arme schwarz, Schirme rubinrot 5 arms black, shades red	5 × G4	ON/OFF	100 W	PO1063	873,95 €	1.040,00 €
	5 Arme schwarz, Schirme violett 5 arms black, shades violet	5 × G4	ON/OFF	100 W	PO1062	873,95 €	1.040,00 €
	5 Arme beige, Schirme keramik 5 arms beige shades ceramic	5 × G4	ON/OFF	100 W	PO1067	873,95 €	1.040,00 €
	5 Arme beige, Schirme rubinrot 5 arms beige shades red	5 × G4	ON/OFF	100 W	PO1066	873,95 €	1.040,00 €
	5 Arme beige, Schirme violett 5 arms beige shades violet	5 × G4	ON/OFF	100 W	PO1065	873,95 €	1.040,00 €

Die Stehleuchten der REFLEX²-Produktfamilie scheinen mit Ihren schwarzen oder weißen Linien lediglich die Konturen eines Quaders nachzuzeichnen. Alle Modelle besitzen eine feine, elegant abgerundete Rahmenstruktur, in der sich die LED-Platinen befinden. Die Deckenfluter strahlen absolut blendfreies Licht über die Decke in den Raum, wohingegen die Leseleuchte sanft, aber intensiv nach unten leuchtet. Aus einer dezenten Struktur entsteht so eine intensive Lichtstimmung. Gesteuert wird das Licht über Taster im Sockel, die beim Modell M zusätzlich zur Helligkeit auch die Lichtfarbe regeln.

The floor luminaires of the REFLEX² family with their black or white lines seem to merely trace the contours of a cuboid. All models have a fine, elegantly rounded framework structure, which contains the LED circuit boards. The ceiling washlights radiate absolutely glare-free light into the room via the ceiling, whereas the reading luminaire provides a soft but intense downward light. A subtle structure that creates an intense lighting atmosphere in the room. The light is controlled via push-buttons in the base, which in the case of the M model not only regulate brightness but also light color.

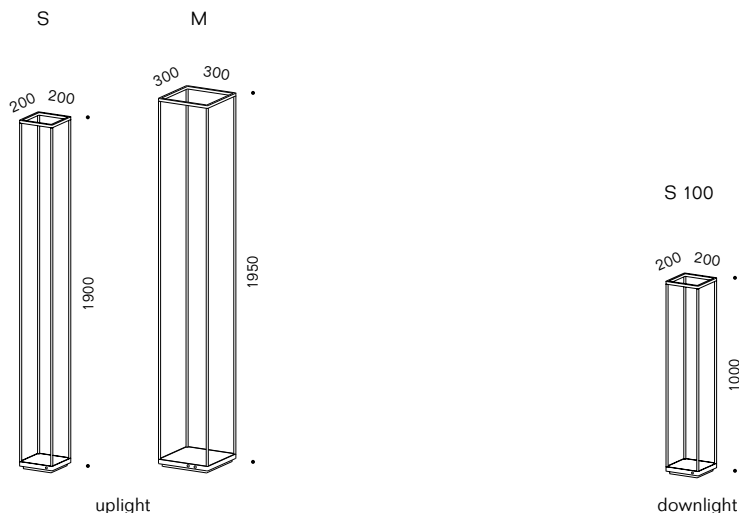

Licht light	nach oben gestreut, indirekt über Decke scattered upwards, diffuse all around via ceiling	nach unten gestreut scattered downwards
Leuchtmittel lamp	LED 35–50 W, CRI Ra>90 (R9>50); S: Dim2Warm, M: 2200–4000 K/tunable white; EEK/EEC E	LED 33 W, CRI Ra>90 (R9>50) Dim2Warm, EEK/EEC E
Material material	Leuchtmittelabdeckungen: Flachglas satinée lamp cover: glass semigloss	
Gehäuse housing	Aluminium schwarz oder weiß beschichtet aluminium black or white coated	
Sonstiges features	LED austauschbar; Kabelaufwicklung unter dem Sockel; Fusstaster für on/off/dimming (S, M) und Colour dimming (M) im Sockel LED exchangeable; Cable wrap below base; push buttons for on/off/dimming (S, M) and colour dimming (M) in the base	



REFLEX² Floor S

Abbildung figure	Beschreibung description	Leuchtmittel lamp	Regelung control	Leistung power	CCT	Lumen lumen	Art.-Nr. art.-no.	€ netto DE excl. VAT	€ brutto DE incl. VAT
●	schwarz black	LED	integr.	33 W	2200–3000 K D2W	3910 lm	RE3501	823,53 €	980,00 €
○	weiß white	LED	integr.	33 W	2200–3000 K D2W	3910 lm	RE3502	823,53 €	980,00 €

REFLEX² Floor M

Abbildung figure	Beschreibung description	Leuchtmittel lamp	Regelung control	Leistung power	CCT	Lumen lumen	Art.-Nr. art.-no.	€ netto DE excl. VAT	€ brutto DE incl. VAT
●	schwarz black	LED	integr.	50 W	2200–4000 K TW	6040 lm	RE3603	1.058,82 €	1.260,00 €
○	weiß white	LED	integr.	50 W	2200–4000 K TW	6040 lm	RE3604	1.058,82 €	1.260,00 €

REFLEX² Floor S 100 new available Q1 2023

Abbildung figure	Beschreibung description	Leuchtmittel lamp	Regelung control	Leistung power	CCT	Lumen lumen	Art.-Nr. art.-no.	€ netto DE excl. VAT	€ brutto DE incl. VAT
●	schwarz black	LED	integr.	33 W	2200–3000 K D2W	3910 lm	RE3701	571,43 €	680,00 €
○	weiß white	LED	integr.	33 W	2200–3000 K D2W	3910 lm	RE3702	571,43 €	680,00 €

SLICE² Floor

SLICE² entwickelt die erfolgreiche SLICE technisch, funktional und formalästhetisch weiter. Der komplett geschlossene Leuchtenkopf sorgt mit einer besonders innovativen Anordnung der Leuchtmittel auf zwei Ebenen für eine optimale Lichtwirkung: Breit nach oben abstrahlende LED-Streifen bieten indirektes, auch bei voller Leistung absolut blendfreies Licht. Nach unten sorgen LED-Leuchtmittel, deren Licht über die Glaskanten eingespeist und von einer prismatischen Scheibe verteilt wird, für ideales, direktes Licht auf der Arbeitsfläche.

SLICE² further develops the successful SLICE with a view to technology, functionality and formal aesthetics. The completely closed luminaire head with its particularly innovative arrangement of illuminants on two levels creates an optimum light effect: Wide-angled upwards-facing LED strips provide indirect light that is entirely glare-free even at full power. Downwards, LEDs whose light is supplied via the glass edges and distributed by a prismatic disk generate ideal direct lighting for work surfaces.

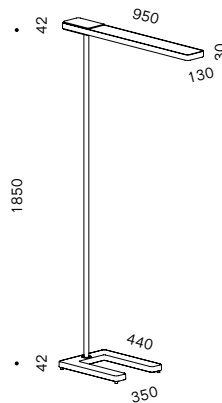

Licht light	direkt nach oben abstrahlend durch Diffusorplatte, nach unten abgeblendet durch Prismenstrukturglas; vereinheitlichte Blendungsbewertung UGR<15, Lichtverteilung: indirekt 85%, direkt 15% beaming upwards through diffuser plate, downwards directed through prism pattern glass; unified glare rating UGR<15, light distribution: indirect 85%, direct 15%
Leuchtmittel lamp	LED 2×41 W, CRI Ra>80, EEK/EEC C
Material material	Leuchtenkopf, Leuchtenrohr und Sockel: Aluminium glanzverchromt (außer Sockel), schwarz, weiß oder silberbeschichtet; Leuchtmittelabdeckung: unten Prismenstruktur-Acrylglas, oben Acrylglas Diffusor lamp head, tube and light unit: aluminium chrome-plated (except base), black, white or silver coated; lamp cover: down prism pattern acrylic glass, top diffuser acrylic glass
Sonstiges features	LED austauschbar; weitere Ausführungen (CCT/CRI/Leistung) möglich LED exchangeable; other technical versions (CCT/CRI/power) on request

SLICE² Floor

Abbildung figure	Beschreibung description	Leuchtmittel lamp	Regelung control	Leistung power	CCT	Lumen lumen	Art.-Nr. art.-no.	€ netto DE excl. VAT	€ brutto DE incl. VAT
●	glanzverchromt, Sockel silber chrome plated, base silver	LED	integr.	82 W	3000 K	12710 lm	SL2001	1.504,20 €	1.790,00 €
					4000 K	13345 lm	SL2002	1.504,20 €	1.790,00 €
●	schwarz black	LED	integr.	82 W	3000 K	12710 lm	SL2101	1.420,17 €	1.690,00 €
					4000 K	13345 lm	SL2102	1.420,17 €	1.690,00 €
○	weiß white	LED	integr.	82 W	3000 K	12710 lm	SL2201	1.420,17 €	1.690,00 €
					4000 K	13345 lm	SL2202	1.420,17 €	1.690,00 €
●	silber silver	LED	integr.	82 W	3000 K	12710 lm	SL2301	1.420,17 €	1.690,00 €
					4000 K	13345 lm	SL2302	1.420,17 €	1.690,00 €

SLICE² Floor Sensorik

Abbildung figure	Beschreibung description	Leuchtmittel lamp	Regelung control	Leistung power	CCT	Lumen lumen	Art.-Nr. art.-no.	€ netto DE excl. VAT	€ brutto DE incl. VAT
●	glanzverchromt, Sockel silber chrome plated, base silver	LED	Sensorik	82 W	3000 K	12710 lm	SL3001	1.672,27 €	1.990,00 €
					4000 K	13345 lm	SL3002	1.672,27 €	1.990,00 €
●	schwarz black	LED	Sensorik	82 W	3000 K	12710 lm	SL3101	1.588,24 €	1.890,00 €
					4000 K	13345 lm	SL3102	1.588,24 €	1.890,00 €
○	weiß white	LED	Sensorik	82 W	3000 K	12710 lm	SL3201	1.588,24 €	1.890,00 €
					4000 K	13345 lm	SL3202	1.588,24 €	1.890,00 €
●	silber silver	LED	Sensorik	82 W	3000 K	12710 lm	SL3301	1.588,24 €	1.890,00 €
					4000 K	13345 lm	SL3302	1.588,24 €	1.890,00 €





FLOOR





FLOOR





FLOOR



THE
SUN
IS
GONE
BUT
WE
HAVE
THE
LIGHT







FLOOR





FLOOR



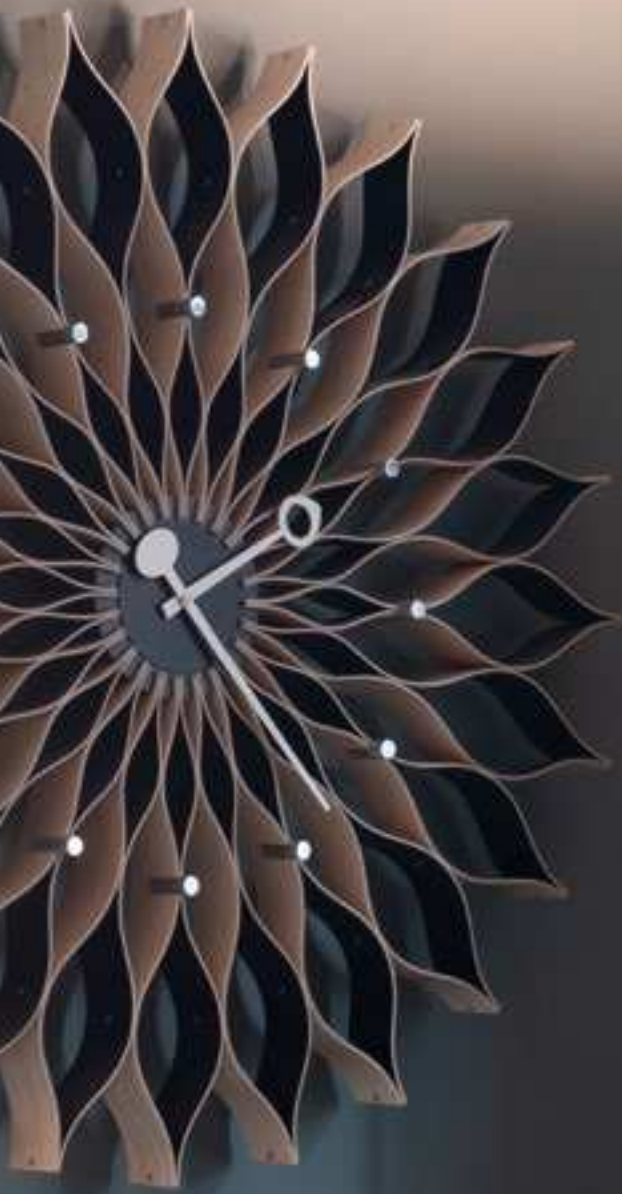









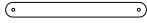

BALDACHINPROFIL 2
CANOPY PROFILE 2
S. 198

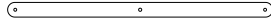

BALDACHINPROFIL 3
CANOPY PROFILE 3
S. 199

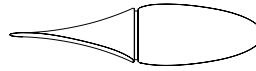

ERSATZBEZUG
REPLACEMENT COVER
S. 200



KRISTALLGLAS ANHÄNGER
CRYSTAL GLAS PENDANT
S. 200



OPTIKEN
OPTICS
S. 201
new



SPIEGEL ADAPTER SET
MIRROR ADAPTER SET
S. 201



WANDADAPTER
WALL COVER
S. 202

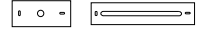

WANDABDECKUNGEN
WALL COVER
S. 203

BALDACHINPROFIL 2 / CANOPY PROFILE 2

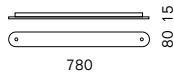

Material Aluminium gebürstet oder poliert, schwarz oder weiß lackiert
material aluminium brushed or polished, black or white coated

Passend für CAVITY Suspension L; CURLING Suspension Rope/Tube S, M, L;
Suitable for DRAFT Suspension Rope/Tube S, M; DRUM Suspension Rope/Tube S, M; REEF Suspension 1

Abbildung figure	Beschreibung description	Art.-Nr. art.-no.	€ netto DE excl. VAT	€ brutto DE incl. VAT
●	gebürstet brushed	BP1001	268,91 €	320,00 €
●	poliert polished	BP1002	294,12 €	350,00 €
●	schwarz black	BP1009	268,91 €	320,00 €
○	weiß white	BP1010	268,91 €	320,00 €



DRAFT Suspension Rope M

Maße measurements

CURLING DRAFT DRUM Suspension Rope M	
CURLING Suspension Rope M	
DRAFT Suspension Rope M	
DRUM Suspension Rope M long	
DRUM Suspension Tube M short	
REEF Suspension 1	

BALDACHINPROFIL 3 / CANOPY PROFILE 3

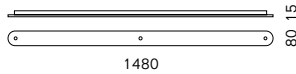

Material Aluminium gebürstet oder poliert, schwarz oder weiß lackiert
material aluminium brushed or polished, black or white coated

Passend für CAVITY Suspension L; CURLING Suspension Rope/Tube S, M, L;
Suitable for DRAFT Suspension Rope/Tube S, M; DRUM Suspension Rope/Tube S, M; REEF Suspension 1

Abbildung figure	Beschreibung description	Art.-Nr. art.-no.	€ netto DE excl. VAT	€ brutto DE incl. VAT
	gebürstet brushed	BP1004	344,54 €	410,00 €
	poliert polished	BP1005	378,15 €	450,00 €
	schwarz black	BP1013	344,54 €	410,00 €
	weiß white	BP1014	344,54 €	410,00 €

Maße
measurements

CURLING
DRAFT
DRUM
Suspension
Rope M

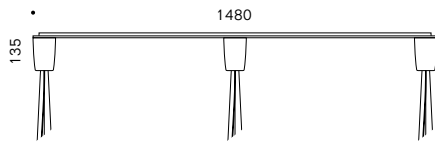

CURLING Suspension Rope M

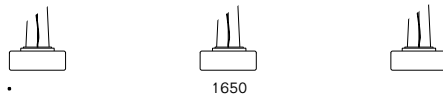

DRAFT Suspension Rope M

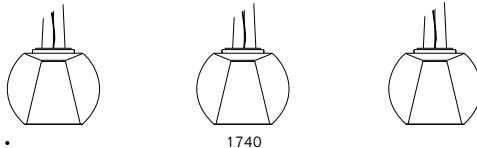

DRUM Suspension Rope M long

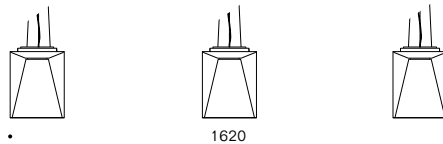

DRUM Suspension Tube M short

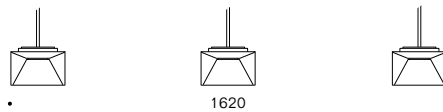

REEF Suspension 1

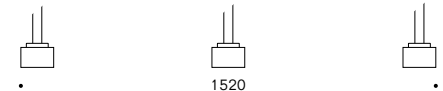

CAVITY Suspension L



CURLING / DRAFT / DRUM
Suspension Tube / Rope M



REEF Suspension

ERSATZBEZUG / REPLACEMENT COVER

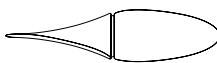

Material
material **Stoffbezug weiß aus 80% Polyamid und 20% Elasthan**
cover white made of 80% polyamide and 20% elastane

Sonstiges
features **werkzeuglose Montage über Federstahldraht**
mounting tool-free to spring steel wire

Passend für
Suitable for PROPELLER

Abbildung figure	Beschreibung description	Art.-Nr. art.-no.	€ netto DE excl. VAT	€ brutto DE incl. VAT
○	weiß white	PR1004	92,44 €	110,00 €

KRISTALLGLAS ANHÄNGER / CRYSTAL GLAS PENDANT



Material
material **mehrgliedrige Anhänger: 3 Octagon-Elemente mit 1 Eiszapfen-Element aus geschliffenem Kristallglas,**
ZOOM Anhänger ca. 60 mm, ZOOM XL Anhänger ca. 100 mm
polynomial pendant: 3 octagon elements with 1 icicle made of edged crystal glass, ZOOM pendant approx.
60 mm, ZOOM XL pendant approx. 100 mm

Sonstiges
features **werkzeuglose Montage durch Einhängen in die unteren Scherengitterdrehpunkte**
simple mounting by hooking in lower snake fence's pivot points

Passend für
Suitable for ZOOM, ZOOM XL

Abbildung figure	Beschreibung description	Art.-Nr. art.-no.	€ netto DE excl. VAT	€ brutto DE incl. VAT
○	ZOOM Kristallglas Set (20 Stk.) ZOOM Kristallglas Set (20 pcs.)	ZO1014	163,87 €	195,00 €
○	ZOOM XL Kristallglas Set (20 Stk.) ZOOM XL Kristallglas Set (20 pcs.)	ZO1015	331,93 €	395,00 €

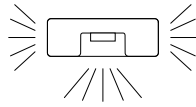

Diffusorscheibe (enthalten)
diffuser (included)

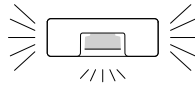

abgeblendet/deglared
CU8535

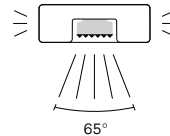

microprismatic
CU8536



Optiken
optics

Mit den einfach austauschbaren Optiken haben Sie die Möglichkeit, die Lichtverteilung der CURLING M zu steuern: In Lieferung enthalten ist eine Echtglas-Streuscheibe für gleichmäßiges, weiches Direkt- und Raumlicht. Optional erhältlich sind eine Entblendungs-Optik für viel Raumlicht und starke Direktlichtentblendung oder eine Mikroprismatik-Optik für gerichtetes Direktlicht im Abstrahlwinkel von 65°.

With the easily replaceable optics, you define the light distribution of CURLING M:
Included in the scope of delivery is a real-glass diffuser lens for uniform, soft direct and ambient light.
Optionally available is the anti-glare optic for intensive ambient light and strong but glare-free direct light or a microprismatic optic for directional direct light with a beam angle of 65°.

Passend für
Suitable for

CURLING M

Abbildung figure	Beschreibung description	Art.-Nr. art.-no.	€ netto DE excl. VAT	€ brutto DE incl. VAT
	Optik abgeblendet Optic deglared	CU8535	35,29 €	42,00 €
	Optik Mikroprismatik Optic microprismatic	CU8536	40,34 €	48,00 €

SPIEGEL ADAPTER SET / MIRROR ADAPTER SET



Material
material

Kunststoffgewindeeinsätze zur Montage auf Echtglasspiegel (bis 8 mm Glasstärke)
plastic thread insert for mounting on glass mirror (up to 8 mm glass thickness)

Passend für
Suitable for

APP Wall, CRIB Wall, LID Wall, SML Wall, SML² Wall
(jeweils alle Größen bzw. Längen) / (all sizes each)

Abbildung figure	Beschreibung description	Art.-Nr. art.-no.	€ netto DE excl. VAT	€ brutto DE incl. VAT
	Set	ZB1001	37,82 €	45,00 €

WALL ADAPTERS / WANDADAPTER

SML² Wall

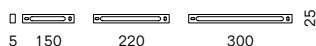

Material material	Aluminium silber, schwarz, weiß lackiert oder poliert aluminium coated silver, black, white or polished
Sonstiges features	Montagehilfe bei nicht mittigem Stromanschluss; weitere Längen auf Anfrage mounting aid for centered power connection; other lengths on request
Passend für Suitable for	SML² Wall 150, 220, 300; weitere Längen auf Anfrage SML ² Wall 150, 220, 300; other lengths on request

Abbildung figure	Beschreibung description	Art.-Nr. art.-no.	€ netto DE excl. VAT	€ brutto DE incl. VAT
●	150 silber 150 silver	SM8801	23,53 €	28,00 €
○	150 weiß 150 white	SM8802	23,53 €	28,00 €
●	150 schwarz 150 black	SM8803	23,53 €	28,00 €
●	150 poliert 150 polished	SM8804	23,53 €	28,00 €
●	220 silber 220 silver	SM8805	26,89 €	32,00 €
○	220 weiß 220 white	SM8806	26,89 €	32,00 €
●	220 schwarz 220 black	SM8807	26,89 €	32,00 €
●	220 poliert 220 polished	SM8808	26,89 €	32,00 €
●	300 silber 300 silver	SM8809	29,41 €	35,00 €
○	300 weiß 300 white	SM8810	29,41 €	35,00 €
●	300 schwarz 300 black	SM8811	29,41 €	35,00 €
●	300 poliert 300 polished	SM8812	29,41 €	35,00 €

WALL COVER / WANDABDECKUNGEN

REFLEX² Wall

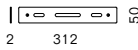

SML Wall

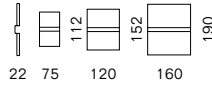

SML² Wall

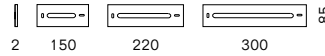

Sonstiges zur Abdeckung von z.B Anschlussdosen
features to cover e.g. junction boxes

REFLEX ² Wall				
Abbildung figure	Beschreibung description	Art.-Nr. art.-no.	€ netto DE excl. VAT	€ brutto DE incl. VAT
●	schwarz black	RE8520	29,41 €	35,00 €
○	weiß white	RE8521	29,41 €	35,00 €
SML Wall				
Abbildung figure	Beschreibung description	Art.-Nr. art.-no.	€ netto DE excl. VAT	€ brutto DE incl. VAT
●	S silber eloxiert S silver anodized	SM1053	31,09 €	37,00 €
●	S glanzverchromt S chrome-plated	SM3053	45,38 €	54,00 €
●	M silber eloxiert M silver anodized	SM1054	32,77 €	39,00 €
●	M glanzverchromt M chrome-plated	SM3054	50,42 €	60,00 €
●	L silber eloxiert L silver anodized	SM1055	37,82 €	45,00 €
●	L glanzverchromt L chrome-plated	SM3055	54,62 €	65,00 €
SML ² Wall				
Abbildung figure	Beschreibung description	Art.-Nr. art.-no.	€ netto DE excl. VAT	€ brutto DE incl. VAT
●	150 silber 150 silver	SM4053	33,61 €	40,00 €
○	150 weiß 150 white	SM4056	33,61 €	40,00 €
●	150 schwarz 150 black	SM4059	33,61 €	40,00 €
●	150 poliert 150 polished	SM4062	33,61 €	40,00 €
●	220 silber 220 silver	SM4054	37,82 €	45,00 €
○	220 weiß 220 white	SM4057	37,82 €	45,00 €
●	220 schwarz 220 black	SM4060	37,82 €	45,00 €
●	220 poliert 220 polished	SM4052	37,82 €	45,00 €
●	300 silber 300 silver	SM4055	42,02 €	50,00 €
○	300 weiß 300 white	SM4058	42,02 €	50,00 €
●	300 schwarz 300 black	SM4061	42,02 €	50,00 €
●	300 poliert 300 polished	SM4048	42,02 €	50,00 €

Information



Unsere Produkte sind so konstruiert, dass beim Austausch von Lichtquellen nur eine qualifizierte Fachkraft sicherstellen kann, dass diese nicht verunreinigt und/oder beschädigt werden. Die Lebensdauer der Lichtquellen wird durch die Montageart mit Wärmeleitpads unmittelbar beeinflusst. Daher wird der nicht fachmännische Austausch von Lichtquellen und separaten Betriebsgeräten als nicht sinnvoll angesehen.

Our products are designed in such a way that when light sources are replaced, only a qualified specialist can ensure that they are not contaminated and/or damaged. The service life of the light sources is directly affected by the mounting method with heat conducting pads. Therefore, the non-professional replacement of light sources and separate control gear is not considered advisable.

* **Sonderausführungen mit anderen Lichtleistungen, Farbwiedergabeindizes, Oberflächen, Kabel- und Rohrlängen auf Anfrage.**
Special versions products with other light outputs, colour rendering indices, surfaces, cable and tube lengths on request.

TRIAC **Diese Leuchten sind mit einem handelsüblichen Phasenabschnittsdimmer regelbar – sie können sowohl ein- und ausgeschaltet als auch in der Helligkeit stufenlos geregelt werden. Dafür ist eine 3-adrige Standard-Netzzuleitung ausreichend.**
Luminaires with this feature can be controlled with a standard phase cut dimmer – it can be switched on and off as well as continuously be controlled in brightness. A 3-wire standard mains cable is sufficient.

DALI **5-adrige Netzzuleitung bei Regelung über DALI oder 0/1–10 V erforderlich.**
0–10 V 5-core mains cable required for control via DALI or 0/1–10 V.
1–10 V

CCT **LED-Leuchten mit einer Farbtemperatur von 2700 K liefern wir kurzfristig.**
LED-Leuchten mit einer Farbtemperatur von 3000 K und höher haben in der Regel längere Lieferzeiten.
We supply LED lights with a colour temperature of 2700 K at short notice.
LED lights with a color temperature of 3000 K and higher usually have longer delivery times.

Lumen **Die Angaben zu Lichtstrom (Lumen) sind Nominalwerte, das heißt reine Modul-Lichtstromwerte.**
Der Lichtstrom gibt an, wieviel Licht nach allen Seiten abstrahlt.
The luminous flux (lumen) specifications are nominal values, i.e. pure module luminous flux values.
The luminous flux indicates how much light radiates in all directions.

D2W **Mit Dim2Warm wird eine Funktionalität der Leuchte bezeichnet, mit der das als angenehm empfundene Dimmverhalten von klassischen Glühfadenlampen imitiert wird. Beim Dimmen wird das Licht nicht nur dunkler, sondern ändert seine Lichtfarbe auch in den warmweißen Bereich.**
Dim2Warm refers to a luminaire functionality that imitates the pleasant dimming behavior of classic incandescent lamps. When dimmed, the light not only becomes darker, but also changes its colour to warm white tone.

TW **Leuchten mit der Tunable White Funktionalität besitzen eine variable Farbtemperatursteuerung von warm- bis kaltweißem Licht.**
Luminaires with the tunable-white functionality have variable colour temperature control from warm to cool white light.

CRI **Der Farbwiedergabeindex wird zur Beurteilung der Qualität der Farbwiedergabe einer Lichtquelle herangezogen.**
The colour rendering index is used to assess the quality of the colour rendering of a light source.

UGR **Bewertung der Blendung**
Unified Glare Rating

+C **kennzeichnet Produkte, in die ein vorprogrammiertes CASAMBI-Modul integriert ist.**

Die CASAMBI Funktionalität ist grundsätzlich für alle unsere Produkte einsetzbar. Für die verschiedenen Integrationsmöglichkeiten (abhängig von der Temperatur: in die Leuchte, in die abgehängte Decke, in den Schalter oder den Verteilerkasten) informieren wir Sie gerne. CASAMBI ist ein Bluetooth-basiertes Lichtsteuerungssystem, das vollständig in die Leuchte oder hinter den Schalter integriert werden kann. Es ist einfach und intuitiv über mobile Devices mit der kostenlosen CASAMBI-App (iOS und Android) bedienbar. CASAMBI erweitert so die Steuerungsmöglichkeiten um Funktionen wie Dimmen, Gruppieren von Leuchten, Programmieren von Gruppen und Szenen, Automatisierungen und vieles mehr. Für ausführlichere Informationen besuchen Sie bitte www.casambi.com

+C indicates products with pre-programmed CASAMBI module integrated in the luminaire.

The CASAMBI functionality is basically applicable to all our products. For the different possibilities of integration (depending on the temperature) – in the luminaire, in the suspended ceiling, in the switch or the distribution box) we will be pleased to inform you. CASAMBI is a lighting control system which is operated via Bluetooth and can be integrated completely into the luminaire or behind the light switch. It is controlled via mobile devices using the free CASAMBI app, making its operation simple and intuitive. CASAMBI expands the possibilities of control with new options such as dimming, the programming of specific scenarios or groups, automations and many more. For further information, please visit www.casambi.com.



Eine Excel-Datei mit Artikelnummern und aktuellen Preisen stellen wir unseren Handelspartnern gerne zur Verfügung unter:
www.serien.com/downloads/

We are happy to make the Excel file with article numbers and current prices available to our trade partners:
www.serien.com/downloads



Unter www.serien.com/downloads finden Sie hilfreiche Informationen und die jeweils aktuellen technischen Daten: Datenblätter, Kataloge, Preislisten, Lichttechnische Daten (EULUMDAT), 3D CAD-Daten, Konformitätserklärungen, Retourenformular, FAQs, Montageanleitungen, Bohrschablonen und weitere Serviceanleitungen

At www.serien.com/downloads you will find helpful information and the latest technical data:
Data sheets, catalogues, price lists, lighting data (EULUMDAT), 3D CAD data, declarations of conformity, returns form, FAQs, assembly instructions, drilling templates and other service instructions.

Awards

ANNEX

2013	German Design Award, Nominierung
2012	Design Plus
2011	Internationaler Designpreis Baden-Württemberg, Focus Silber

APP

2017	German Design Award, Special Mention
2016	Design Plus
2016	Iconic Award, Interior Innovation, Winner

CAVITY

2019	German Design Award, Winner
2019	Nominierung Leuchte des Jahres

CURLING

2020	Innovationspreis Architektur+Technik
2018	German Design Award, Winner
2016	Internationaler Designpreis Baden-Württemberg, Focus Silber
2016	Iconic Award, Interior Innovation, Best of Best

CRIB

2019	German Design Award, Winner
------	-----------------------------

ELANE

2012	Deutscher Designer Club, Gute Gestaltung, Bronze
------	--

JOB

2011	Designpreis der Bundesrepublik Deutschland, Nominierung
2010	Deutscher Designer Club, Gute Gestaltung, Silber
2009	The Israel Museum, Collection

JONES

1999	Red Dot Design Award
------	----------------------

LID

2018	Iconic Award, Innovative Interior, Best of Best
------	---

ONE EIGHTY

2011	Designpreis der Bundesrepublik Deutschland, Nominierung
2010	Red Dot Design Award, Winner

PROPELLER

2009	Designpreis der Bundesrepublik Deutschland, Nominierung
2009	The Israel Museum, Collection
2008	Red Dot Design Award, Winner

REEF

2006	Designpreis der Bundesrepublik Deutschland, Nominierung
2004	Red Dot Design Award, Winner
2004	Design Plus
2004	Designpreis der Bundesrepublik Deutschland, Nominierung
2003	Internationaler Designpreis Baden-Württemberg, Focus Silber

ROD

2019	Iconic Award, Innovative Interior, Best of Best
------	---

REFLEX²

2022	Internationaler Designpreis Baden-Württemberg, Special Mention
2022	German Design Award, Winner (Floor)
2022	Iconic Award, Innovative Interior, Best of Best
2021	Stylepark Selected
2021	Internationaler Designpreis Baden-Württemberg, Special Mention
2020	Design Plus
2020	German Design Award, Winner (Ceiling)

SEVENTY SEVEN

1991	iF Product Award
1991	Stedelijk Museum Amsterdam, Collection

SLANT

2013	German Design Award, Nominierung
2012	Deutscher Designer Club, Gute Gestaltung, Silber

SLICE

2015	German Design Award, Nominierung
------	----------------------------------

SML

2006	Designpreis der Bundesrepublik Deutschland, Nominierung
2004	Red Dot Design Award, Winner
2004	Designpreis der Bundesrepublik Deutschland
2003	Internationaler Designpreis Baden-Württemberg, Focus Silber

SML²

2014	German Design Award, Nominierung
2013	Designpreis der Bundesrepublik Deutschland, Nominierung
2013	Red Dot Design Award, Winner

SML T5

2004	Design Plus
2004	Designpreis der Bundesrepublik Deutschland
2004	iF Product Award, Winner
2003	Internationaler Designpreis Baden-Württemberg, Focus Silber

TWIN

2015	German Design Award, Gold
2014	Design Plus

ZOOM

2007	Designpreis der Bundesrepublik Deutschland, Nominierung
2004	Designpreis der Bundesrepublik Deutschland, Nominierung
2003	Red Dot Design Award, Winner
2003	Internationaler Designpreis Baden-Württemberg, Focus Gold

Service

Bei Fragen zu unseren Produkten, deren Lieferbedingungen und Verfügbarkeiten kontaktieren Sie bitte unser Serviceteam.

+49 6106 6909 0
serien@serien.com
www.serien.com

We are distributing worldwide.
For questions about our products, their delivery conditions and availabilities, please contact our customer service any time.

Business Contacts

Gebiet Nord/Ost

PLZ 0, 1 - 39 und 99

serien Raumeuchten GmbH
Dzenan Ganibegovic

Hainhäuser Straße 3-7
63110 Rodgau
Germany

E dzenan.ganibegovic@serien.com
M +49 151 5122 1212
T +49 6106 6909 248

Gebiet West

PLZ 4, 50 - 54, 56 - 59

serien Raumeuchten GmbH
Tatjana Bräunl

Hainhäuser Straße 3-7
63110 Rodgau
Germany

E tatjana.braeunl@serien.com
M +49 151 426 435 39
T +49 6106 6909 0

Gebiet Mitte

PLZ 55, 60 - 65

serien Raumeuchten GmbH
Peter Salat

Hainhäuser Straße 3-7
63110 Rodgau
Germany

E peter.salat@serien.com
M +49 179 496 57 43
T +49 6106 6909 232

Gebiet Süd

PLZ 66 - 98

serien Raumeuchten GmbH
Helmuth Grischy

Hainhäuser Straße 3-7
63110 Rodgau
Germany

E helmuth.grischy@serien.com
M +49 151 5092 8656
T +49 6106 6909 252

Austria

serien Raumeuchten GmbH
Peter Salat

Hainhäuser Straße 3-7
63110 Rodgau
Deutschland

E peter.salat@serien.com
M +49 179 496 57 43
T +49 6106 6909 232

Switzerland

wirzpartner GmbH
für Leuchten und Licht

Werner-Weber-Str. 11
8630 Rüti
Schweiz

E info@wirzpartner.ch
M +41 79 290 30 08
T +41 55 260 19 60

Benelux

serien Raumeuchten GmbH
Tatjana Bräunl

Hainhäuser Straße 3-7
63110 Rodgau
Germany

E tatjana.braeunl@serien.com
M +49 151 426 435 39
T +49 6106 6909 0

Brasil

FAS iluminação

Alameda Gabriel Monteiro da Silva,
n° 413 Jardim America
00.817.414/0001-08 – São Paulo
Brazil

E atendimento@fasiluminacao.com.br
T +55 11 30861661
M +55 11 94713-9743

Australia

Archebiosis Architects
Edith Clark

Shop 3B, 780 Bourke Street
NSW 2016 Redfern
Australia

E edith@archebiosis.com
T +61 2 83992334

Greece & Cyprus

Christos Keletzis

Werrastr. 42
60486 Frankfurt
Germany

E christos.keletzis@serien.com
T +49 171 5725684

Portugal

In-One
Manuela Peres

EN 125
8100-O68 Benfarras/Boliqueime
Portugal

E manuelaperes@in-one.pt
T +35 1938460199

Russia

serien Raumeuchten GmbH
Tatjana Bräunl

Hainhäuser Straße 3-7
63110 Rodgau
Germany

E tatjana.braeunl@serien.com
M +49 151 426 435 39
T +49 6106 6909 0

Impressum Imprint

serien Raumleuchten GmbH, HRB 22042 Amtsgericht Offenbach. Geschäftsführer/Managing Directors: Jean-Marc da Costa, Manfred Wolf. Copyright: serien Raumleuchten GmbH 2022. **Alle Rechte vorbehalten. Keine Reproduktionen ohne vorherige schriftliche Zustimmung. Alle Marken sind registriert. Alle Produkte sind gesetzlich geschützt. Verstöße werden in vollem Umfang strafrechtlich verfolgt. Änderungen vorbehalten.** All rights reserved. No reproductions without prior written consent. All trademarks are registered. All products are protected by law. Infringements will be prosecuted to the fullest extent. Subject to alteration without notice. **Konzeption** Concept: serien.lighting; **Projektleitung** Projektmanagement: Nina da Costa **Gestaltung** Graphic Design: Sandra Doeller; **Renderings** serien.lighting – preyer3d.de **Postproduction** David Helmrich, Peter Schladoth, Nicola Riva **Druck** Printing: pruskil

THANK YOU to hosts, artists and photographers:

Cover Foto Haus B, München DE – Studio Olaf Becker; **04 ANNEX** Ceiling: products – Christoph Lison; **06 CAVITY** Ceiling: products – serien.lighting; **08 CURLING** Ceiling: products – Christoph Lison, 3D serien.lighting; **12 DRAFT** Ceiling: products – serien.lighting, preyer3d.de; **26 ANNEX** Ceiling: products – Christoph Lison; **27 ANNEX** Ceiling M: Next Munich GmbH, München DE – Studio Olaf Becker; **28 ANNEX** Ceiling M: Privat, Frankfurt am Main DE – Christoph Lison; **29 ANNEX** Ceiling M: Frank Landau, Frankfurt am Main DE – Farideh Fotografie; **30 ANNEX** Ceiling L: Seven Swans, Frankfurt am Main DE – Ingmar Kurth; **31 ANNEX** Ceiling M: Universitätsbibliothek Bern, Bern CH – Studio Olaf Becker; **33 CAVITY** Ceiling S: appartement/showroom, Bayern DE, www.stephanie-thatenhorst.com – Studio Olaf Becker; **34 CURLING** Ceiling M: Privat, Frankfurt am Main DE – Farideh Fotografie; products – Christoph Lison, 3D serien.lighting; **35 CURLING** Ceiling M: Privat, Frankfurt am Main DE – Farideh Fotografie; **36/37 CURLING** Ceiling S: hauser lacour, Frankfurt am Main DE – Farideh Fotografie; **38/39 CURLING** Ceiling M: Himmelrich, Luzern CH – Studio Olaf Becker; **40 DRAFT** Ceiling: products – serien.lighting, preyer3d.de; **41 DRAFT** Ceiling M: Privat, Stuttgart DE, www.nowherearchitekten.de – Studio Olaf Becker; **42 DRUM** Ceiling: products – serien.lighting, preyer3d.de; **43 DRUM** Ceiling M short: Privat, Brüssel BE – Studio Olaf Becker; **44 DRUM** Ceiling M long: Privat, Stuttgart DE, www.nowherearchitekten.de – Studio Olaf Becker; **45 DRUM** Ceiling M short: Office, Bozen IT – Studio Olaf Becker; **46 POPPY** Ceiling 5: Uli Holzinger, Frankfurt am Main DE – Ingmar Kurth; **47 REEF** Ceiling: Karl Henschel, Offenbach am Main – Ingmar Kurth; Product – Christoph Lison; **48 REFLEX²** Ceiling M 150: appartement/showroom, Bayern DE, www.stephanie-thatenhorst.com – Studio Olaf Becker; **49 REFLEX²** Ceiling M 300: Haus B, München DE – Studio Olaf Becker; **50 REFLEX²** Ceiling M 450: Product – serien.lighting, preyer3d.de; **51 REFLEX²** Ceiling S 600: Ingmar Kurth, Frankfurt am Main DE; **52 REFLEX²** Ceiling M 450: Haus B, München DE – Studio Olaf Becker; **53 REFLEX²** Ceiling M 450: Haus B, München, DE – Studio Olaf Becker; **54 SLICE²** PI Ceiling: products – serien.lighting, preyer3d.de; **55 SLICE²** PI Ceiling: Ingmar Kurth; **58 ANNEX** Suspension: products – Christoph Lison; **60 CAVITY** Suspension: products – serien.lighting, preyer3d.de; **63 CURLING** Suspension: products – Christoph Lison, 3D serien.lighting; **66 DRAFT** Suspension: products – serien.lighting, preyer3d.de; **70 ONE EIGHTY** Suspension: products – Christoph Lison; **78 ANNEX** Suspension L: Prashad&Schwarck, Frankfurt am Main DE – Christoph Lison; **79 ANNEX** Suspension M: Next Munich GmbH DE – Studio Olaf Becker; **80 CAVITY** Suspension L: Bürgeramt der Stadt Frankfurt am Main DE, www.jacoby-architects.de – Studio Olaf Becker; **81 CAVITY** Suspension: products – serien.lighting, preyer3d.de; **82 CAVITY** Suspension S: Privat, Stuttgart DE, www.nowherearchitekten.de – Studio Olaf Becker; **83 CAVITY** Suspension S: Wohnung K, München, DE – Studio Olaf Becker; **84 CURLING** Suspension Rope L: Himmelrich, Luzern CH – Studio Olaf Becker; **85 CURLING** Suspension: products – serien.lighting, preyer3d.de; **86 DRAFT** Suspension Rope M: M4 Offices, München DE – Studio Olaf Becker; **87 DRAFT** Suspension Rope S/M: Privat, Stuttgart DE, www.nowherearchitekten.de – Studio Olaf Becker; **88 DRUM** Suspension Rope M: Ingmar Kurth, Frankfurt am Main DE; **89 DRUM** Suspension Tube M: Schule, München DE – Studio Olaf Becker; **90 ONE EIGHTY** Suspension L Adjustable: Moon Dog Studio, Frankfurt am Main DE – Ingmar Kurth; **91 ONE EIGHTY** Suspension L Adjustable: Restaurant Margarete, Frankfurt am Main DE – Christoph Lison; **92 POPPY** Suspension: Tony McNeveins, Wiesbaden DE – Ingmar Kurth; **93 PROPELLER**: Product – Christoph Lison; **94 REEF** Suspension 3: Moon Dog Studio, Frankfurt am Main DE – Ingmar Kurth; **95 TWIN**: Schmidt Apartment, Frankfurt am Main DE – Ingmar Kurth; **96 ZOOM 3**: MHK Küchen, Dreieich DE – Studio Olaf Becker; **97 ZOOM 1**: Privat, CH – Heinz Dahinden; **98 ZOOM XL**: bigstock.com – David Helmrich; **99 ZOOM XL 2**: Café Wacker, Frankfurt am Main DE – Jean-Marc da Costa; **102 APP** Wall: products – Christoph Lison; **104 CAVITY** Wall: products – serien.lighting, preyer3d.de; **107 CRIB** Wall: Products – serien.lighting, preyer3d.de; **108 CURLING** Wall: products – serien.lighting, preyer3d.de; **110 LID** Wall: products – serien.lighting, preyer3d.de; **116 REEF** Wall – Christoph Lison; **117 REFLEX** Wall: products – serien.lighting, preyer3d.de; **118 ROD** Wall: products – serien.lighting, preyer3d.de; **126 APP** Wall: Privat, Frankfurt am Main DE – Farideh Fotografie; **127 APP** Wall: Privat, Frankfurt am Main DE – Ingmar Kurth; **128 CAVITY** Wall S: Privat, Stuttgart DE, www.nowherearchitekten.de – Studio Olaf Becker; **129 CAVITY** Wall S: products – serien.lighting, preyer3d.de; **130 CLUB** Wall: Restaurant Margarete, Frankfurt am Main DE – Ingmar Kurth; **131 CURLING** Wall S/M: Haus B, München DE – Studio Olaf Becker; **132/133 CURLING** Wall M: Himmelrich, Luzern CH – Studio Olaf Becker; **134 CRIB** Wall: Ingmar Kurth, Frankfurt am Main DE; **135 CRIB** Wall: Haus B, München DE – Studio Olaf Becker; **136 LID** Wall IP44: Goethequartier, Offenbach DE – Christoph Lison; **137 LID** Wall: Office, Planegg DE, Ricardo Alves GmbH – Studio Olaf Becker; **138 LID** Wall: Privathaus, Budapest HU – Christoph Lison; **139 LID** Wall: products – serien.lighting, preyer3d.de; **140 POPPY** Wall 2: Uli Holzinger, Frankfurt am Main DE – Ingmar Kurth; **141 REEF** Wall: products – Christoph Lison; **142 REFLEX²** Wall 300 – Christoph Lison; **143 REFLEX²** Wall 300: products – serien.lighting, preyer3d.de; **144 ROD** Wall: Weingut Alfred Küchle, Frankfurt am Main DE – Ingmar Kurth; **145 ROD** Wall: Haus B, München DE – Studio Olaf Becker; **146 SML** Wall: Wohnung B, Berlin DE – Ingmar Kurth; **147 SML²** Wall 300: Universitätsbibliothek Bern, Bern CH – Studio Olaf Becker; **148 SML²** Wall 220: Soho Turley, Mannheim DE – Farideh Fotografie; **149 SML²** Wall 220: Shift, Frankfurt am Main DE – Christoph Lison; **150 SML** Wall: products – Christoph Lison; **151 SML** Wall: Bettmeralp, CH – Thomas Andenmatten; **155 REFLEX** Table: products – serien.lighting, preyer3d.de; **160 JOB** Table: Doris Fratton DE – Ingmar Kurth; **161 POPPY** Table: Juan Amador Suite DE – Christoph Lison; **162/163 REFLEX²** Table: Privat, Stuttgart DE, www.nowherearchitekten.de – Studio Olaf Becker; **164 SLICE²** Furniture Chrome: Office Westend, Frankfurt am Main DE – Christoph Lison; **165 SLICE²** Furniture Chrome: Zollverein School, Essen DE – Ingmar Kurth; **172 REFLEX²** Floor: products – serien.lighting, preyer3d.de; **178/179 CENTRAL** Floor: Privat, Frankfurt am Main DE – Ingmar Kurth; **180 CLUB** Floor: products – Christoph Lison; **181 CLUB** Floor: Haus B, München DE – Studio Olaf Becker; **182 CLUB** Floor: Haus B, München DE – Studio Olaf Becker; **183 CLUB** Floor: Wohnung K, München DE – Studio Olaf Becker; **184 JONES** Floor: Privat, Frankfurt am Main DE – Farideh Fotografie; **185 JONES** Floor: Privat, Frankfurt am Main DE – Farideh Fotografie; **186/187 POPPY** Floor: Liv Johansson Weicker, Darmstadt DE – Farideh Fotografie; **188 REFLEX²** Floor S: Wohnung K, München DE – Studio Olaf Becker; **189 REFLEX²** Floor M: Privat, Stuttgart DE, www.nowherearchitekten.de – Studio Olaf Becker; **190 REFLEX²** Floor S: Haus B, München DE – Studio Olaf Becker; **191 REFLEX²** Floor M: Weingut Alfred Küchle, Frankfurt am Main DE – Ingmar Kurth; **192/193 REFLEX²** Floor S 100: Privat, Stuttgart DE, www.nowherearchitekten.de – Studio Olaf Becker; **194 SLICE²** Floor: 2030 Agentur für Kommunikation, München DE – Studio Olaf Becker; **195 SLICE²** Floor: M4 Offices, München DE – Studio Olaf Becker; **198 DRAFT** Suspension M: Ingmar Kurth, Frankfurt am Main DE

Mit Erscheinen dieser Preisliste verlieren alle bisherigen Preislisten ihre Gültigkeit. Die angegebenen Bruttopreise enthalten den zum Zeitpunkt der Drucklegung in Deutschland gültigen Mehrwertsteuersatz von 19%. Die dargestellten Produktzeichnungen dienen der Illustration. Auch wenn bei deren Erstellung mit großer Sorgfalt vorgegangen wurde, können einzelne Proportionen vom tatsächlichen Produkt abweichen. Alle Maße in Millimetern, sofern nicht anders angegeben. Für alle Aufträge gelten die Liefer- und Zahlungsbedingungen der serien Raumleuchten GmbH. Änderungen und Irrtümer vorbehalten. Preis Anpassungen sind auch während der Preislistenlaufzeit möglich.

This price list supersedes all previously published price lists. The gross prices shown include the german value added tax rate of 19% valid at the time of printing. Retail prices may differ with local sales taxes applied. The drawings shown in this document are for informational purposes only. Although great care has been taken when creating them, their proportions may not correctly reflect the proportions of the real product. All dimensions are millimetres unless specifically declared otherwise. All orders are accepted subject to the Conditions of Sale of serien Raumleuchten GmbH. Subject to alteration without notice. Prices may be adjusted during the period covered by the price list.



scan for PDF



@serien.lighting
www.serien.com